



A GENTHERM COMPANY

# EZT-570i

*Technical Manual*



**TABLE OF CONTENTS**

<b>1. Overview.....</b>	<b>4</b>
1.1 Safety Information.....	4
1.2 How to Use this Manual.....	4
<b>2. Where Do I Begin?.....</b>	<b>5</b>
<b>3. Resolving “Loop Comms Failure” Alarms .....</b>	<b>7</b>
3.1 Determining the Source of a “Loop Comms Failure” .....	7
<b>4. Chamber Operating Problems .....</b>	<b>8</b>
4.1 Conditioning System.....	9
4.1.1 Temperature Limited Sheath heaters .....	9
4.1.2 Rate Master Operation .....	9
4.1.3 Defrost Operation .....	10
4.1.4 Dual Refrigeration.....	11
4.1.4.1 <i>Alternating Defrost</i> .....	11
4.1.5 Conditioning System Failures and Corrective Actions .....	12
4.1.6 Conditioning System Logic Flow .....	14
4.2 Humidity System.....	17
4.2.1 Humidity System Failures and Corrective Actions .....	18
4.2.2 Humidity System Logic Flow .....	19
4.3 Auxiliary Cooling System.....	20
4.3.1 Auxiliary Cooling System Failures and Corrective Actions.....	20
4.3.2 Auxiliary Cooling System Logic Flow.....	21
4.4 Dry Air Purge System .....	22
4.4.1 Dry Air Purge System Failures and Corrective Actions.....	22
4.4.2 Dry Air Purge System Logic Flow.....	23
4.5 Altitude System.....	24
4.5.1 Altitude System Failures and Corrective Actions .....	24
4.5.2 Altitude System Logic Flow .....	25
4.6 Fluid Systems.....	26
4.6.1 Fluid System Failures and Corrective Actions.....	27
4.6.2 LC Fluid System Logic Flow .....	27
4.7 Transfer Mechanism.....	28
4.7.1 Transfer Mechanism Failures and Corrective Actions.....	28
4.7.2 Transfer System Logic Flow .....	29
<b>5. Remote PC Communication Problems .....</b>	<b>31</b>
5.1 Serial Communications Troubleshooting.....	32
5.1.1 CSZ EZ-View Software.....	33
5.2 GPIB Communications Troubleshooting .....	34
5.3 Ethernet Communications Troubleshooting .....	35
<b>6. User Interface (HMI) Troubleshooting.....</b>	<b>36</b>
6.1 HMI Troubleshooting and Corrective Actions.....	37
6.1.1 Configure Windows CE Startup Directory .....	39
6.1.2 Configure Serial Port 1 Mode .....	40
6.1.3 Touch Screen Calibration .....	42
6.1.3.1 <i>Dip Switch Calibration Procedure</i> .....	42
6.1.3.2 <i>USB Mouse Calibration Procedure</i> .....	43

**TABLE OF CONTENTS (cont'd)**

<b>7.</b>	<b>Deciphering EZT Input/Output (I/O) Operation</b>	<b>46</b>
7.1	Standard Input Configuration	47
7.1.1	Input Description of Use	48
7.1.1.1	Custom Input Description of Use (DTS, VTS, TSB)	53
7.1.1.2	Custom Input Description of Use (Dual Refrigeration)	54
7.2	Standard Output Configuration	58
7.2.1	Output Description of Use	59
7.2.1.1	Custom Output Configuration (Altitude)	63
7.2.1.2	Custom Output Configuration (DTS, VTS, TSB)	64
7.2.1.3	Custom Output Configuration (Tandem/Redundant Refrigeration)	65
7.3	Control Module Status Indicators	67
<b>8.</b>	<b>Adjusting EZT Configuration options</b>	<b>68</b>
8.1	Accessing the EZT Configurator	68
8.2	Number of Loops/Monitors	71
8.3	Loops/Monitor Tagnames	72
8.4	Chamber Options	74
8.5	Refrigeration Options	76
8.5.1	Refrigeration Advanced Options	78
8.6	Humidity Options	80
8.7	Purge/Lo RH Options	82
8.8	Auxiliary Cooling Options	83
8.9	Configuration Options	84
8.10	CSZ Events	85
8.11	Critical Chamber Alarms	86
8.12	Critical Refrigeration Alarms	87
8.13	Non-Critical Alarms	88
8.14	Maintenance Alarms	89
8.15	Special Settings Tagnames	90
8.16	Completing EZT570i Configuration	91

**Appendix**

- List of Figures
- List of Tables

## 1. Overview

This technical manual has been written to aid in the troubleshooting of chamber operational issues and/or malfunctions. Note that not all options and/or features discussed in this guide may be available or applicable to the particular chamber that is being serviced. It is highly recommended that you read this material thoroughly prior to performing any diagnostic service in order to better assist you in locating the section(s) that apply to your situation.

### 1.1 Safety Information

Note, caution and warning symbols that appear throughout this manual are to draw your attention to important operational and safety information.



A “**NOTE**” marks a short message to alert you to an important detail.



A “**CAUTION**” safety alert appears with information that is important for protecting your equipment and performance.



A “**WARNING**” safety alert appears with information that is important for protecting you, others and equipment from damage. Pay very close attention to all warnings that apply to your chamber.

### 1.2 How to Use this Manual

To start using this manual, see Section 2, Where Do I Begin? This will assist you in finding the correct section for further information on how to diagnose and correct the problem.



*Remember to keep it simple. Don't try and solve everything at once. Take each issue one-at-a-time. It may take several “trips” through this guide to correct each problem or locate the root cause of a single fault, but by breaking it down into pieces, you can simplify the process and solve it in less time.*

*In many instances, one component failure or incorrect control setting can cause various chamber malfunctions that would point you in several different directions, none of which may be correct. Always try and work backwards from what is not working correctly and determine why. Why is this not working, what makes it work and/or how should it work?*



## 2. Where Do I Begin?

The EZT-570i is a Distributed Control System (DCS) that uses different hardware layers to perform the various functions needed to operate the chamber. These include the user interface (HMI), the control module (CM) which handles system monitoring and protection, as well as process control (9300 controllers). This type of platform distributes the work load of controlling the chamber into different devices and allows us to break the system down into these layers for troubleshooting which makes diagnosing problems quicker.

Instead of looking at the system as a whole, look at each component and focus on what task it is performing and whether or not it is doing it right. Start from the component level when tracing a problem and work backwards from what is not working. Some problems are obvious. If I am trying to enter a set point and the touch screen is not responding to my touch, then it is a problem with the HMI. However, when the chamber is not doing something it is supposed to, is it the controller or something else? Over 90% of the time it can be attributed to a wiring fault or single component failure that prevents the system from operating. It isn't the controller.

**Example:** The chamber is at 75°F and the set point is 185°F. The fans are running, but it is not heating up. What is wrong?

Instead of approaching the problem by assuming the controller is not calling for heat, ask why is the chamber not heating up? Are the heaters on? Using the electrical schematic for the chamber, locate the power wiring for the heater. Is there voltage to the heaters? Is the heat output of the controller on, i.e., is the solid state relay on to supply power to the heater. Is the heater contactor on? Is there a blown fuse?

Start from the heaters and work back. This will allow you to find what is not allowing power to pass to the heaters. It may even be several components, like the contactor and solid state relay, both of which get power from a common wire that may be shorted or open due to a limit device which needs to be manually reset.

The EZT performs the same function on the chamber as any other controller. It has heat and cool outputs for controlling temperature based on a set point. It has humidify and dehumidify outputs to control humidity based on a set point. These outputs control the same heaters, compressors and solenoids that any other controller would.

Since the EZT has a host of additional features and more functionality than other controllers, it is not uncommon to look inward on the controller and blame it for any problems that arise. However, software does not change. If it worked yesterday, then it is working today. What may not be working is a valve that reached then end of its cycle life or a wire that has come loose or corroded to a point where it will no longer pass power. Those types of failures are far more common.



*An alarm condition may be present and not indicated on the EZT if a hardware failure or wiring problem exists. Keep this in mind when there are no obvious fault conditions present that would indicate why the chamber is not working properly.*

In order to begin troubleshooting an issue, narrow down the search by determining which section of this guide the problem most likely falls into based on the following information.

**Section 3. Resolving “Loop Comms Failure” Alarms**

This section provides detailed assistance on locating and correcting serial communication problems between the control module (CM) and 9300 loop controllers.

**Section 4. Chamber Operating Problems**

Use this section to diagnosis problems when no alarm messages are present. Why are the compressors not turning on? Why is humidity not turning on when the event is on? This helps you determine if there is a real problem or if the chamber is doing what it is supposed to.

**Section 5. Remote Communication Problems**

Use this section to diagnose connection problems relating to the use of the serial, Ethernet and optional IEEE interfaces.

**Section 6. User Interface (HMI) Troubleshooting**

This section covers issues that may arise with the EZT display such as a non-responsive touch screen or the EZT failing to start due to a communications failure or other hardware problems.

**Section 7. Deciphering EZT Input/Output (I/O) Operation**

This section reviews the functionality of the inputs and outputs of the EZT and how they are used and controlled. This section can assist you in determining if there is a wiring or hardware problem that may be causing the chamber to not operate properly.

**Section 8. Adjusting EZT Configuration Options**

This section reviews the use of the EZT’s configurator and how the settings affect the operation of the chamber. This section is for experienced service personnel only. Changing certain settings from the original factory settings can cause damage to equipment and/or injury to personnel. CSZ is not responsible for damages or losses attributed to unauthorized changes of these settings.

This section is provided to assist with the installation of chamber options not provided originally on the unit at the factory. Certain options, when added in the field, may require modification to specific configurator settings in order for them to operate properly.

### **3. Resolving “Loop Comms Failure” Alarms**

The “Loop Comms Failure” alarm indicates that there is a problem with serial communications between the control module (CM) and the 9300 loop controllers. The communications between the CM and the 9300 controllers is performed by the control module through the RS485 communications adapter (port 2).

When this alarm occurs, the chamber will shut down and not be able to be restarted until the alarm condition is cleared. The cause of this alarm may lie in one of several areas. The problem could be with the 9300 loop controller itself, the wiring between the 9300 controller and the CM or the RS485 communications adapter on the CM.

#### **3.1 Determining the Source of a “Loop Comms Failure”**

The first step in finding the cause of the communications alarm is to determine the extent of the failure. Is it just a single 9300 causing the problem or is communications down to all 9300 controllers? A simple test to check for this is to change the setpoint of each control loop of the EZT750 and verify that the setpoint updates on the 9300 controller.

For example, if the air temperature setpoint is currently 85.0 degrees and you change the setpoint to 25.0 degrees, but the 9300 controlling air temperature (typically 1-INST) still has a setpoint of 85.0, then that may indicate the 9300 controller is the cause of the alarm. To verify this, perform the same test for each control loop. If all 9300 setpoints update to the new values entered, then from this example, it can be determined that the 9300 controlling air temperature is the cause of the problem.



*When performing the setpoint change test for the humidity control loop, if the chamber is equipped with a non temperature compensated humidity sensor, the humidity setpoint entered may not match that on the 9300 controller depending upon the current air temperature reading. This is due to the temperature compensation algorithm in the EZT-570i. In this case, it is only necessary to verify that the setpoint changes.*

*When checking the product control loop, note that the product loop temperature setpoint will be the same as that entered for the chamber air temperature when product control is disabled. This allows you to check both the air temperature and product temperature control loops at the same time with a single setpoint change.*

If it is determined that a single 9300 is the cause of the communications failure, verify that the rear terminal connector is seated properly on the back of the controller. If the connector is not seated correctly, it can cause intermittent connection between the internal circuits of the controller and the wiring terminals resulting in the communications failure. Also verify that the proper communications settings are used. If all connections and settings appear to be correct, than replacement of the 9300 controller may be necessary.

If none of the setpoints on any of the 9300 controllers update when a new entry is made, then the cause of the problem may be in the wiring or the RS485 communications adapter on the control module. Inspect the wiring thoroughly looking for any shorts to ground or between leads. Verify that all shields are properly connected at one end only of each section of communication wiring. If all of the wiring appears to be in good condition, then the last step is to replace the RS485 communications adapter on the EZT-570i control module.



***When replacing the communications adapter, make sure to disconnect power prior to removing and replacing the current adapter. Failure to remove power prior to performing the replacement procedure may cause irreparable damage to the control module’s CPU.***

## **4. Chamber Operating Problems**

This section provides direction on troubleshooting chamber operation when no alarm condition is present. It is broken into sub-sections for temperature, humidity, altitude control, etc. Locate the section that most closely relates to the problem at hand in order to help diagnose and solve it.

### **Section 4.1 Conditioning System**

This section covers typical problems that may arise with the chamber's heating and refrigeration systems. It includes information regarding the operation of temperature limited sheath heaters for special use as well as information on rate-master and defrost operating conditions in order to help diagnose any problems that may occur with their operation.

### **Section 4.2 Humidity System**

This section covers typical problems that may arise with the chamber's humidity system. It also includes information regarding the operation of the low RH mode (frozen coil) in order to help diagnose any problems that may occur during operation.

### **Section 4.3 Auxiliary Cooling System**

This section covers typical problems that may arise with the chamber's auxiliary cooling system. It includes information regarding the operation of both the boost cooling and cooling control modes in order to help diagnose any problems that may occur during operation.

### **Section 4.4 Dry Air Purge System**

This section covers typical problems that may arise with the chamber's dry air purge system. It includes information regarding the operation of the low RH mode (frozen coil) in order to help diagnose any problems that may occur during operation.

### **Section 4.5 Altitude System**

This section covers typical problems that may arise with the chamber's altitude system.

### **Section 4.6 Fluid Systems (LC/TSB)**

This section covers typical problems that may arise with the chamber's fluid system. It also includes information regarding hot oil heating systems for special use on explosion proof (EXP) chambers.

### **Section 4.7 Transfer Mechanism (DTS/VTS/TSB)**

This section covers typical problems that may arise with the basket transfer mechanism. It includes information regarding the operation for both air and motor operated systems.

## **4.1 Conditioning System**

When the main chamber event is turned on, whether it be a standard ZP, TSB or VTS for example, temperature control is the primary function. The air circulator/bath output will turn on and enable the heating/cooling logic. Even though the air circulator/bath output (typically Q2 or Q44) may vary based on the type of chamber, it performs the same function.

The minimum heat/cool enable output (Q41), if equipped, turns on with the chamber event to enable the control circuits for heating and cooling. This output is typically only used and wired into the control circuit when the chamber is equipped with defrost. In defrost, the output would turn off in order to disable the heating and cooling control circuits while defrost is running.

The maximum cool output (Q1) and maximum heat output (Q31) are controlled by the configurator settings. When the cooling or heating output percent exceeds the configurator setpoint for the on delay period, the maximum output will turn on. They operate as boost outputs, i.e., they are on/off outputs, not proportioning outputs. They connect additional heating and cooling circuits to the 9300 controller outputs in order to boost chamber performance.

Heating operation is relatively basic; however, the refrigeration system operation is more complicated with staging of compressors, etc. Depending upon options present on the chamber, it may include the rate master refrigeration system operation and/or defrost. The sequence of operation then varies from that of a typical chamber.

### **4.1.1 Temperature Limited Sheath heaters**

Temperature limited sheath heaters are used in applications where there is, or may be, the presence of a flammable substance within the chamber. These heaters operate at lower surface temperatures than standard open element, nichrome wire heaters and their surface is not electrically “live”. This allows a temperature sensor, typically a thermocouple, to be placed on their surface. The sensor is then connected to a limit device.

This limit device monitors the surface temperature of the heater and turns off the power to the heater when the surface temperature exceeds the maximum operating limit. The limit device overrides any call for heating by the chamber controller. Once the temperature drops below the operating limit, power is restored to the heaters if heating is still required. The operating temperature limit is dictated by the flammable material. The maximum operating temperature of the heater surface can be no higher than 80% of the auto-ignition temperature of the flammable material in degrees centigrade.

### **4.1.2 Rate Master Operation**

The operation of the refrigeration system varies with temperature for a rate master system. When the chamber air temperature is above the rate master lockout setpoint, typically -20°C (-4°F), as set in the configurator, and the air temperature setpoint is at or above the switchover setpoint, typically 0°C (32°F), the refrigeration system operates in single stage mode. The system 1 compressor output (Q3), solenoids output (Q30) and the rate master control output (Q40) will be on when cooling is required.

The rate master control output is used to switch the cooling output of the 9300 loop controller from the system 2 cooling solenoids over to the system 1 cooling solenoids. The maximum cool output will turn on and off based on the demand for cooling as normal. The refrigeration system will switch over to cascade mode when the air temperature drops below the switchover setpoint and the air temperature setpoint is below the lockout setpoint. During the switch from single stage to cascade mode, the cascade cooling control output (Q43) will turn on and the maximum cooling output (Q1) will be disabled. This allows some of system 1’s capacity to be diverted to the cascade condenser to pre-cool it prior to system 2 starting.

After the stager start delay, system 2's output (Q4) will turn on and the rate master control output (Q40) will turn off. The cooling output of the 9300 will now be used to control system 2 cooling solenoids. The maximum cool output (Q1) is then re-enabled so that it can turn on system 2 maximum cool solenoids if needed. For safety, when the air temperature is below the lockout setpoint, the system will only start and run in cascade mode. This prevents the system 1 evaporator from becoming a condenser (due to the lower chamber air temperature) and causing liquid slugging of the system 1 compressor.

**4.1.3 Defrost Operation**

There are two base selections for defrost in the EZT's configurator. These are regular and large horsepower defrost. Defrost can also be configured for regular or large horsepower alternating defrost; however, these selections are only available if the chamber is configured with redundant refrigeration systems and independent plenums. If it is a tandem refrigeration system where both systems work together in a combined plenum, then alternating defrost is not available.

The large horsepower selection is typically used on systems 7.5HP and larger. The difference between the selections defines how system 1 is controlled in order to cool system 2. With standard defrost, the system 1 compressor is cycled on and off based on system 2 head pressure. With large horsepower defrost, system 1 compressor remains in operation while output Q43 cycles system 1 cascade cooling solenoids on and off to maintain system 2 head pressure.

Defrost can be manually initiated by turning on the defrost event, or it can be automatically started by the EZT based on the defrost settings. When in automatic mode, the defrost timer will begin counting down whenever the air temperature set point is below the defrost set point. Once the timer counts down to zero, defrost is initiated for one cycle. Upon completion of the cycle, the timer will begin the next timed countdown.

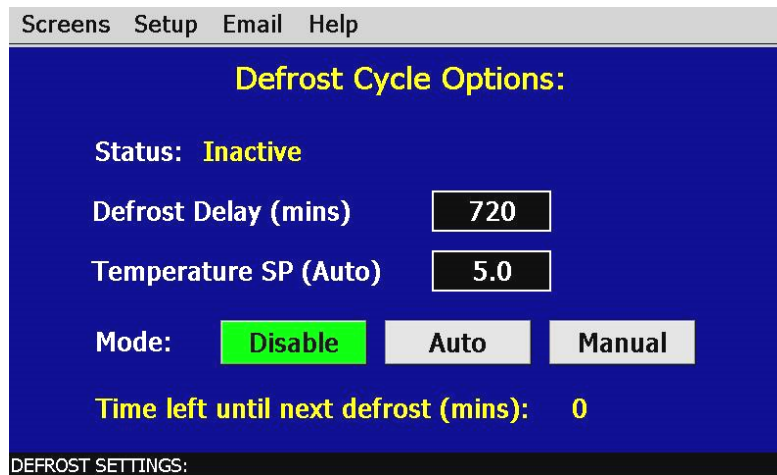

*Figure 4-1 Defrost Settings*

When defrost is started, the air circulator output is turned off. The minimum heat/cool output is also turned off. This prevents any heating or cooling from taking place. The defrost solenoid output (Q42) will turn on and system 2 will continue operating. This supplies hot gas to the cooling coil. If defrost is set up for regular operation, system 1 compressor will be cycled on and off to provide cooling to system 2 based on the defrost pressure control input (I40). If large horsepower defrost is selected, the system1 compressor will remain on, and the cascade cooling output (Q43) will be cycled on and off to provide cooling to the cascade for system 2.

This process will continue until the defrost temperature switch input (I41) is made indicating that the suction temperature of the coil has warmed up to the defrost temperature setting. This will initiate a 15 minute timer in the EZT. Defrost will continue for another 15 minutes to insure that the coil is completely defrosted. Once the 15 minute defrost time has elapsed, prechill is started.

In prechill, the defrost solenoid will be turned off and the minimum heating/cooling output (Q41) will be turned on. This will allow the refrigeration system to pre cool the coil prior to starting the air circulators. Once the defrost temperature switch turns off, indicating that the suction line has dropped below the defrost temperature, a one minute timer begins. Once this timer is complete, prechill will terminate, the air circulators will turn back on, and the system will resume normal operation.

#### **4.1.4 Dual Refrigeration**

Dual refrigeration refers to two refrigeration systems working together or alternately to condition the chamber. When the refrigeration systems are set to tandem operation, they work together. When cooling or dehumidification is required, both systems will start and stop in unison as required based on the cooling and/or dehumidification demand. When redundant operation is specified, only one refrigeration system runs at a time, and the systems alternate back and forth on a duty cycle to equalize runtime.

The first system, system 'A', uses the standard control outputs for system 1 and 2 compressor (Q3 and Q4). System 'B' compressors are assigned to outputs Q46 and Q47 for system 1 and system 2. The EZT also uses input I31 for the system 1B pumpdown switch and Q45 for the system 1B solenoids, which allows independent control and pumpdown of system 1B. When each system is assigned to its own conditioning plenum, additional inputs and outputs are used to start and stop the air circulators on plenum 'B' (Q44) as well as monitor for heater over temperature (I4), motor overload (I5) and a second boiler system on the additional plenum (I30 and I46).

When independent system failure is configured, a safety trip on one system will not shut down the other system. This allows the chamber to continue to "limp" along with only one system under tandem operation, or to switch to the "back-up" system when operating in redundant mode. If independent plenums are not used, the chamber would still operate if it was a refrigeration safety trip; however, if the fault was associated with a motor overload or over temperature condition with the chamber heaters, the chamber would shut down because both refrigeration systems share the same plenum.

When independent control loops are specified, requiring independent conditioning plenums, the EZT will send the same temperature and humidity setpoints to the 9300 controllers for each plenum. The EZT will then average the readings together when running in tandem mode, or only utilize the values from the operating plenum when in redundant mode.

##### **4.1.4.1 Alternating Defrost**

When alternating defrost is selected for redundant refrigeration systems, and defrost has been initiated on the currently running system, system 'A' for example, the EZT will start system 'B' prior to starting the defrost cycle. This minimizes the change in chamber temperature by allowing system 'B' to begin operation first. Once the defrost cycle has completed on system 'A'; however, the prechill step will not take place. Since system 'B' is currently cooling the chamber, there is no need to prechill the coil because system 'A' not required. If for some reason system 'B' was faulted out and unavailable, the prechill step would take place prior to restarting system 'A' because it is then required to cool the chamber.

Note that when defrost is in automatic mode, the EZT will not begin counting down the next defrost cycle for system 'B' until defrost is complete on system 'A' and vice versa.



**4.1.5 Conditioning System Failures and Corrective Actions**

SYMPTOM	PROBABLE CAUSES	CORRECTIVE ACTIONS
Chamber air circulator(s) not turning on.	Chamber event not turned on. Conditioning system disabled (altitude chambers). Blown fuse. Chamber in defrost (if equipped). Basket not in correct position (DTS/VTS). Chamber door open (if door switch enabled in configurator).	Turn on chamber event. Altitude above controllable limit for temperature. Decrease altitude or turn off altitude system. Replace Fuse. Check defrost status. Allow defrost to complete or terminate defrost. Check basket position and adjust if necessary. Check basket position sensors, adjust/replace. Close chamber door.
Chamber not heating.	Chamber event not on. Conditioning system disabled (altitude chambers). Blown heater fuse. Sheath heater limit tripped. 9300 controller output off. Chamber in defrost (if equipped).	Turn on chamber event. Altitude above controllable limit for temperature. Decrease altitude or turn off altitude system. Replace fuse. Check heater limit. Maximum temperature reached. Verify proper 9300 controller configuration. Check set point. Replace 9300 controller. Check defrost status. Allow defrost to complete or terminate defrost.
System 1 compressor not turning on.	Chamber event not on. Conditioning system disabled (altitude chambers). Blown fuse. Compressor internal thermal overload tripped. Chamber in defrost (if equipped). Refrigeration system not enabled or compressor percent on set point not exceeded for delay time.	Turn on chamber event. Altitude above controllable limit for temperature. Decrease altitude or turn off altitude system. Replace fuse. Allow compressor to cool. Check refrigeration system/injection valve operation. Check defrost status. Allow defrost to complete. Compressor will cycle as needed. Check configurator settings. Refrig system type should match installed system type.
System 2 compressor not turning on.	Blown fuse.	Replace fuse.



SYMPTOM	PROBABLE CAUSES	CORRECTIVE ACTIONS
	<p>Compressor internal thermal overload tripped.</p> <p>Chamber in humidity mode.</p> <p>Refrigeration system not enabled or stager start delay time not met.</p>	<p>Allow compressor to cool. Check refrigeration system/injection valve operation.</p> <p>Check humidity system type. System 2 disabled for single stage humidity operation.</p> <p>Check configurator settings. Refrigeration system type should match installed system type. Wait for stager start delay period.</p>
<p>Chamber not cooling.  (further diagnosis and/or repair requires certified refrigeration service personnel)</p>	<p>Chamber event not on.</p> <p>Conditioning system disabled (altitude chambers).</p> <p>Cooling coil fouled with ice build-up.</p> <p>9300 controller output off.</p> <p>Chamber in defrost (if equipped).</p> <p>Refrigeration system capacity exceeded.</p>	<p>Turn on chamber event.</p> <p>Altitude above controllable limit for temperature. Decrease altitude or turn off altitude system.</p> <p>Initiate defrost or warm up chamber to melt ice from coil. Seal ports or leaks in chamber to minimize moisture migration into chamber and accumulating on coil.</p> <p>Verify proper 9300 controller configuration. Check set point. Replace 9300 controller.</p> <p>Check defrost status. Allow defrost to complete or terminate defrost.</p> <p>Reduce live load in chamber.</p>
<p>Defrost not starting.</p>	<p>Suction line not below defrost thermostat setting.</p> <p>Defrost thermostat not working.</p>	<p>Check thermostat setting. Defrost not required.</p> <p>Check thermostat set point and operation. Adjust/replace.</p>
<p>Defrost not terminating.</p>	<p>Defrost delay off period (15 minutes) not completed.</p> <p>Defrost thermostat not working.</p>	<p>Allow enough time for defrost sequence to complete.</p> <p>Check thermostat set point and operation. Adjust/replace.</p>

**4.1.6 Conditioning System Logic Flow**

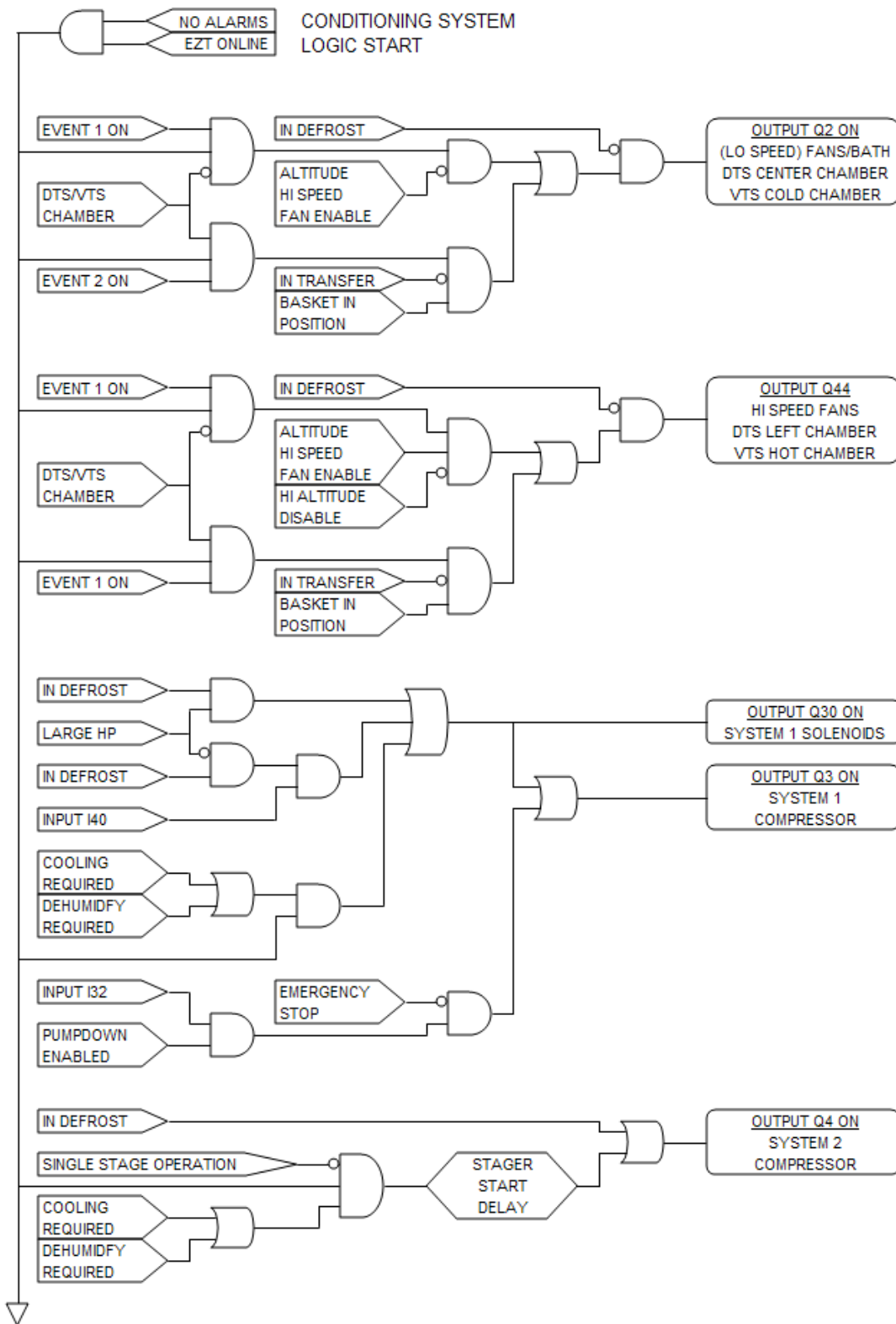

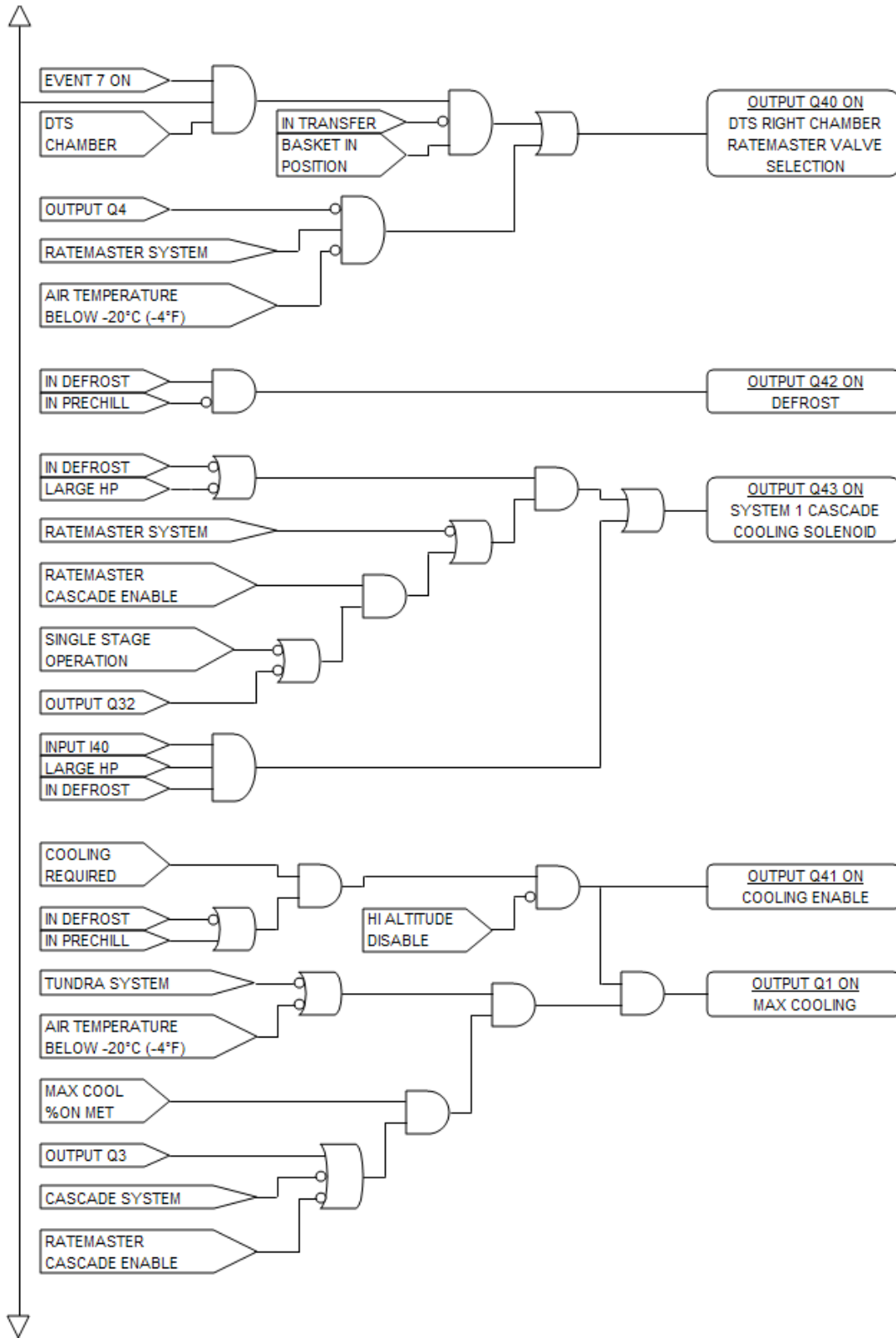

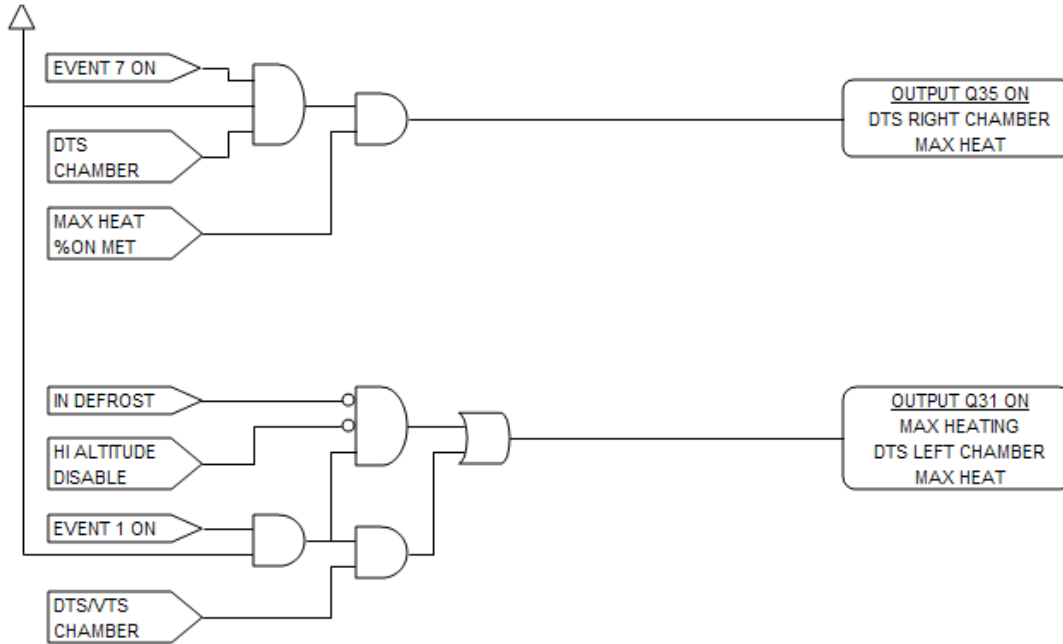

**!** The logic for the system 'B' refrigeration system is the same as that shown in the chart above for a standard chamber with a single refrigeration system. The logic is merely duplicated and tied to different outputs for the control of the second system.

## **4.2 Humidity System**

When the humidity system is enabled, the humidity system output (Q32) will turn on. This turns on water supply solenoids and atomizer air compressor if applicable. If the refrigeration system is set to run in single stage mode when humidity is on, system 2 compressor (Q4) will then be turned off as long as humidity is on. The maximum humidify output (Q33) will turn on whenever the humidification output percentage exceeds the set point in the configurator for the on delay time period.

An alarm delay is added to the boiler low water input (I7) in order to allow enough time for it to fill with water when the humidity system is first turned on. The delay will prevent the alarm from going off for a period of 30 minutes. Should the level not be made in that time, the alarm will sound and shut down the chamber. Once the proper water level is reached, the alarm will sound and shut down the chamber immediately upon losing the input. Should the alarm occur, silence the alarm from the alarm monitor screen and the chamber will begin operating again and restart the 30 minute alarm delay timer.

### **Temperature Limits**

The EZT limits the humidity system's operational range to a minimum and maximum temperature as set in the configurator. These limits are typically set around freezing and boiling temperatures. Once the air temperature exceeds either limit, the EZT shuts down the humidity system automatically. If the humidity system is shut down due to temperature limitations, the system status monitor will indicate that this has occurred by illuminating the "RH TMP DISABLE" indicator. The humidity system will restart automatically once the air temperature returns to within the set temperature range.

### **Dewpoint Limits**

In order to protect the refrigeration system and chamber from damage, there are minimum and maximum dewpoint levels that are set in the configurator. These limits in turn define the minimum and maximum relative humidity levels that the chamber will operate to at any given temperature. The EZT uses these limits and internally calculates the minimum and maximum humidity level that the chamber will control to at the current chamber temperature.

Should the user enter a set point outside of those limits, the EZT will coerce the 9300 set point to the minimum or maximum value allowed. The system status monitor will then indicate that limiting is taking place and in which direction by illuminating the appropriate LED on the system status monitor screen.

### **Low RH (Frozen Coil)**

For chambers equipped with the low RH (frozen coil) option, the EZT monitors the temperature and relative humidity set points and calculates the resulting dewpoint. When this value is below the standard wet coil range of 2°C (35°F), the EZT automatically switches to frozen coil mode. This allows the chamber to reach lower humidity levels than what is capable with standard humidity. The EZT does not initiate frozen coil mode until the measured dewpoint in the chamber is below 10°C (50°F). This prevents the coil from loading up with moisture prematurely and reducing the duration of time at which the coil can affectively control low humidity levels in the chamber.

When frozen coil mode is initiated, the frozen coil control output (Q35) turns on. This activates the EPR bypass solenoid and transfers control from the wet coil solenoid to the frozen coil solenoid to the dehumidification output of the 9300 controller.

**4.2.1 Humidity System Failures and Corrective Actions**

SYMPTOM	PROBABLE CAUSES	CORRECTIVE ACTIONS
Humidity system not turning on.	Humidity event not turned on. Air temperature outside of humidity control range. Altitude system on (altitude chambers). Humidity not enabled in configurator.	Turn on humidity event. Change temperature set point to within allowable humidity control range. Turn off altitude system. Check configurator settings.
Chamber not humidifying.	Maximum dewpoint limit reached. Boiler filling with water/heating up. Blown boiler heater fuse. 9300 controller output off. Atomizer nozzle clogged. Atomizer water supply low. Atomizer air supply low.	Check system status monitor. Chamber operating at maximum humidity level. Check water supply. Allow time for boiler to heat up. Replace fuse. Verify proper 9300 controller configuration. Check set point. Replace 9300 controller. Check/clean atomizer nozzle. Check water supply. Increase flow rate. Verify air compressor operation. Check for leaks/cracks in tubing.
Chamber not dehumidifying. (further diagnosis and/or repair requires certified refrigeration service personnel)	Minimum dewpoint limit reached. Dehumidification coil logged with moisture. 9300 controller output off.	Check system status monitor. Chamber operating at minimum humidity level. Check coil. Warm up chamber to remove moisture build-up. Verify proper 9300 controller configuration. Check set point. Replace 9300 controller.

**4.2.2 Humidity System Logic Flow**

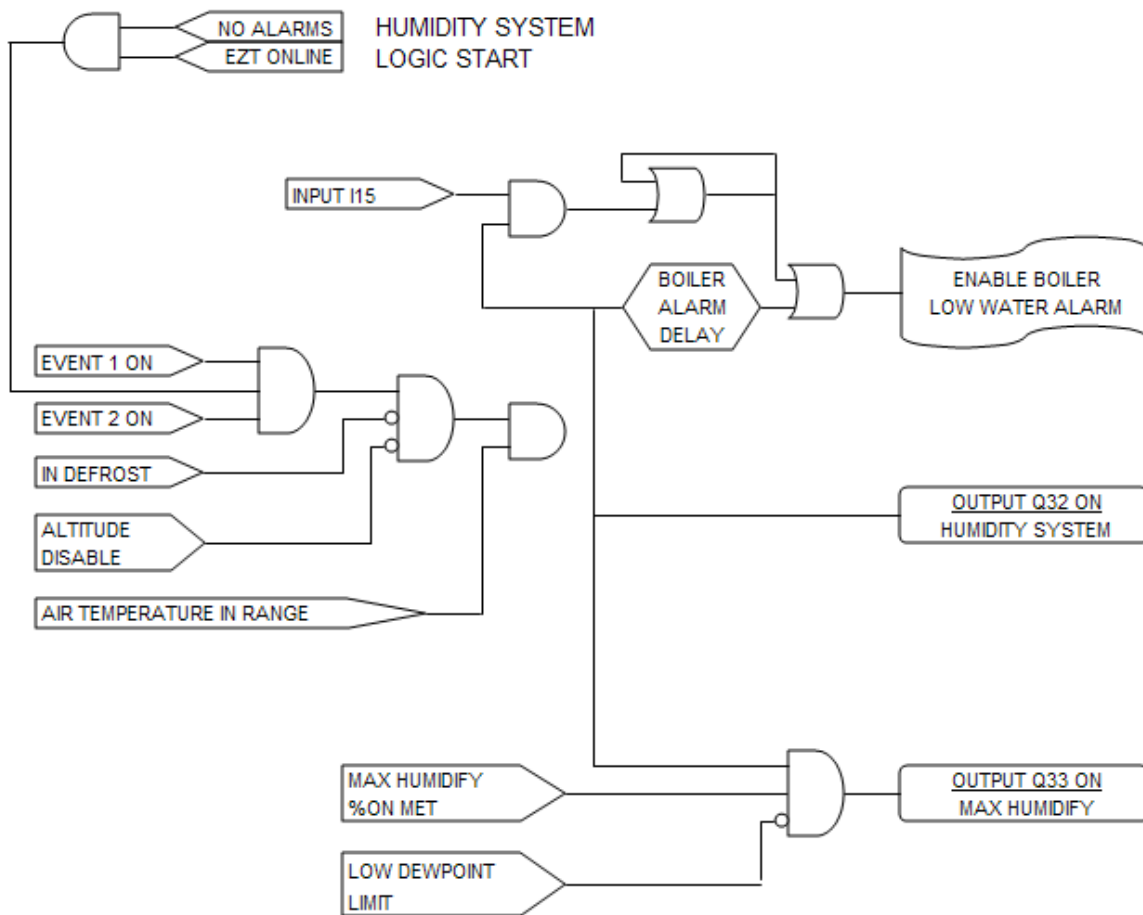

### 4.3 Auxiliary Cooling System

The auxiliary cooling system can be installed as a boost system or a low range control system. When set as a boost, it will assist the refrigeration system in lowering chamber temperatures quickly. As a control, it will take over once the low temperature limit of the refrigeration system is reached and continue cooling the chamber down to an ultimate low of the auxiliary cooling medium (LN2 or CO2).

#### Auxiliary Cool Boost Operation

When the auxiliary cooling option is set for boost in the configurator, the auxiliary cooling supply valve output (Q36) will turn on when the chamber and auxiliary cooling events are enabled. The EZT will then monitor the cooling percentage of output. When it exceeds the auxiliary cooling on percentage set point for the on delay time period, the boost cool output (Q37) will turn on. When the percentage of output drops below the on percentage set point, the output will turn off. The supply valve output will remain on as long as the event is on. Only the boost output will cycle on and off for control.

Once the air temperature reaches the low limit set point in the configurator (boost cool disable), the boost cooling output will be disabled to prevent the chamber from going colder than what the refrigeration system is capable of in order to protect the compressors.

#### Auxiliary Cool Control Operation

When auxiliary cooling is set for control in the configurator, the auxiliary cooling system will operate according to the boost control logic until the low limit set point is reached. The low limit set point in the configurator (boost cool disable) is the lowest safe operating range for the refrigeration system.

Once the low limit set point temperature is reached, the refrigeration system is shut down and the minimum heat/cool output (Q41) is disabled. This transfers the cooling output from the 9300 controller to the auxiliary cooling control solenoid. This allows the chamber to be controlled to temperatures below what the refrigeration system can produce.

#### 4.3.1 Auxiliary Cooling System Failures and Corrective Actions

SYMPTOM	PROBABLE CAUSES	CORRECTIVE ACTIONS
Boost cooling not turning on.	Auxiliary cooling event not turned on.  Loop percentage of output not exceeding on percentage for delay period.  Air temperature at minimum allowable range.  Altitude system on (altitude chambers).	Turn on auxiliary cooling event.  Check loop output percentage, adjust configurator settings if necessary for performance.  Chamber at low limit. Can not go any colder.  Turn off altitude system.
Poor cooling performance with auxiliary cooling on.	Cooling medium (LN2/CO2) not reaching chamber as liquid.          Supply/control valve clogged/failed.	Allow boost cooling to run longer in order for liquid to reach chamber.  Insulate supply lines.  Install automatic purge system to bleed off gas in order to maintain liquid in supply line.  Inspect valve. Clean/Replace if necessary.



**4.3.2 Auxiliary Cooling System Logic Flow**

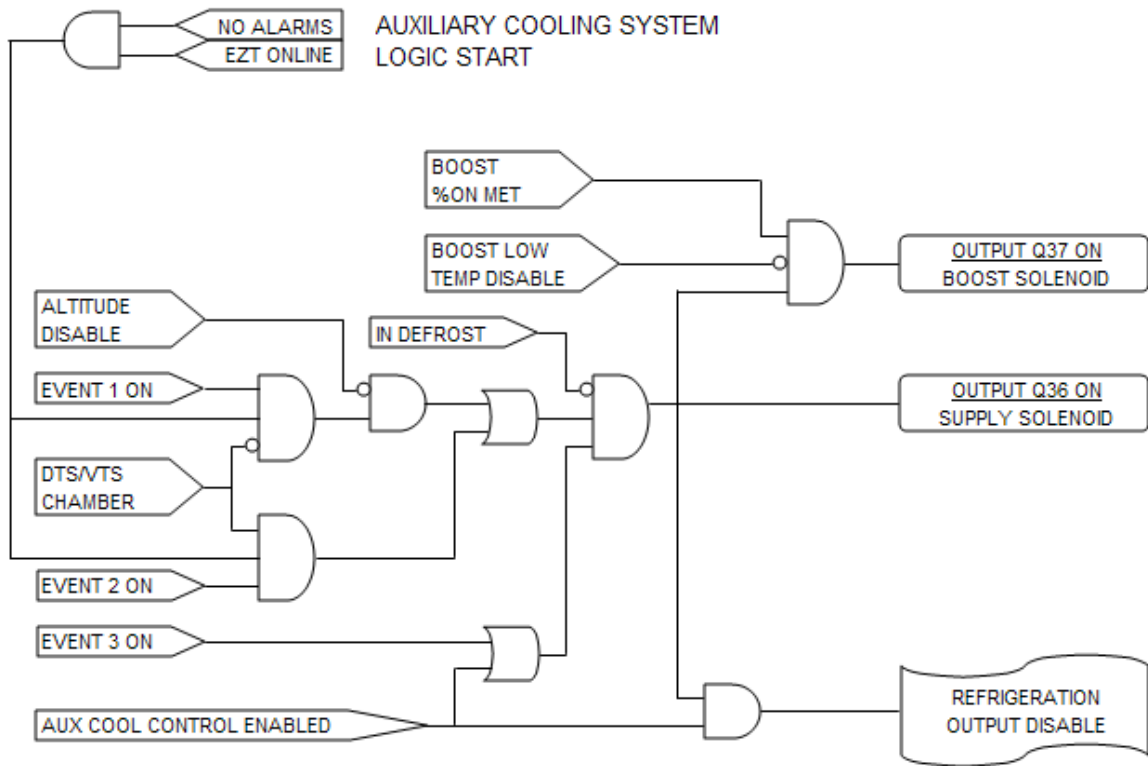

**4.4 Dry Air Purge System**

The dry air purge system can work independently or as part of the humidity system. If the chamber is a standard dry unit (non humidity) or the humidity system is off, the dry air purge output (Q34) will turn on when the chamber and purge events are turned on. The purge system will run continuously supplying dry air to the chamber until the event is turned off.

If the chamber is equipped with humidity, the dry air purge system output (Q34) will be automatically turned off when the humidity system is turned on. This is done in order to allow the humidity system to control the humidity level. If the purge system was allowed to continue operation, it would be constantly trying to dry the chamber regardless of the humidity set point. However, if the minimum dewpoint limit is reached, the humidity system will allow the dry air purge system to operate when the purge event is on, in order to obtain the lowest possible humidity level. The purge system will act as the primary method of dehumidification since the wet coil is limited by the low dewpoint limit.

For chambers equipped with the low RH (frozen coil) option; the purge system will automatically run during low RH humidity operation. The EZT monitors the temperature and relative humidity set points and calculates the resulting dewpoint. When this value is below the standard wet coil range, the EZT will automatically switch to frozen coil mode. The EZT does not initiate frozen coil mode until the measured dewpoint in the chamber is below 10°C (50°F). This prevents the coil from loading up with moisture prematurely and reducing the duration of time at which the coil can affectively control low humidity levels in the chamber.

When frozen coil mode is initiated, the dry air purge system output (Q34) and air control solenoid output (Q35) turn on. The air control solenoid output transfers control of the purge air supply to the chamber over to the dehumidification output of the 9300 loop controller. This allows the dry air purge to be controlled along with the dehumidification solenoid for proper humidity control.

**4.4.1 Dry Air Purge System Failures and Corrective Actions**

SYMPTOM	PROBABLE CAUSES	CORRECTIVE ACTIONS
Purge system not supplying dry air to chamber.	Purge system off. No compressed air supply. Purge flow meter adjusted too low. Supply/control valve clogged/failed.	Turn on purge event. Supply compressed air to purge system. Verify/adjust flow meter for proper flow rate. Inspect valve. Clean/Replace if necessary.
Dry air purge not turning on.	Purge event not turned on. Chamber operating in humidity mode. Altitude system on (altitude chambers).	Turn on purge event. Purge automatically controlled. Dry air purge will turn on automatically when required. Turn off humidity. Turn off altitude.



**4.5 Altitude System**

When the altitude system is enabled, the altitude system output (Q45) will turn on. This turns on the vacuum pump and any isolation valves to seal the chamber. The maximum dive output (Q46) and maximum vacuum output (Q47) are controlled by the configurator settings. When the loop output percent exceeds the configurator set point for the on delay period, the maximum output will turn on. They operate as boost outputs, i.e., they are on/off outputs, not proportioning outputs. They connect additional air and vacuum supply circuits to the control outputs in order to boost chamber performance.

The altitude system automatically disables humidity, auxiliary cooling and dry air purge when it is turned on. These systems can not run when the altitude system is on. The conditioning system is allowed to run until the altitude reaches the conditioning system disable set point in the configurator. Once this altitude is reached, both heating and cooling is shut down. During the allowed operating range, the air circulator motors will switch from low speed (output Q2) to high speed (output Q44) once the high speed fan enable set point is reached. This improves the heating and cooling performance at higher altitudes due to the low air density in the chamber.

**4.5.1 Altitude System Failures and Corrective Actions**

SYMPTOM	PROBABLE CAUSES	CORRECTIVE ACTIONS
Chamber not increasing in altitude.	Altitude turned off. Manual dive valve open. Vacuum pump not running. Leak in chamber. 9300 controller output off. Vacuum control valve clogged/failed.	Turn on altitude event. Close dive valve. Check/replace fuse. Reset overload. Check for leaks. Check door gaskets and latches for tight seal. Verify proper 9300 controller configuration. Check set point. Replace 9300 controller. Inspect valve. Clean/Replace if necessary.
Chamber not decreasing in altitude.	No compressed air supply. 9300 controller output off. Air supply control valve clogged/failed.	Check/supply chamber with compressed air. Check pressure regulator setting. Verify proper 9300 controller configuration. Check set point. Replace 9300 controller. Inspect valve. Clean/Replace if necessary.

**4.5.2 Altitude System Logic Flow**

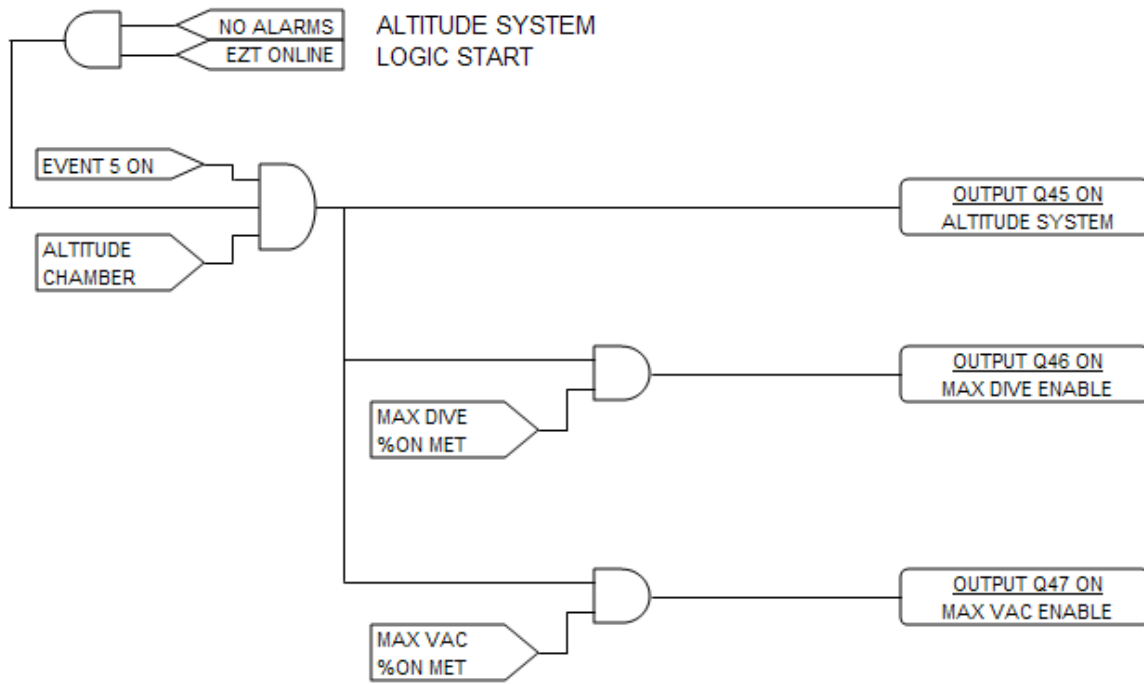

## **4.6 Fluid Systems**

Fluid systems can vary considerably between different types of chambers. LC's, TSB's and explosion proof chambers are typical candidates for fluid systems. For LC's and TSB's, it is the only means of heating and cooling the product under test.

Troubleshooting fluid system problems generally ends up with a heating or cooling system diagnosis. As long as fluid is flowing at the proper rate, temperature control falls back to the heating and cooling systems. As long as the pump is operating properly and all isolation valves are open, there isn't much to consider.

### **LC Chambers**

When the chamber event is turned on, the fluid system pump is started in order to keep fluid flowing through the system to condition the test product. The fluid is heated and cooled as it flows through the heater barrel and heat exchanger much like the air across the heater and evaporator in a typical chamber.

The fluid system is equipped with safeties that insure that fluid is flowing through the system prior to allowing heating or cooling of the fluid to commence. This protects the system and components from damage that may occur by operating with no fluid flow. The heating and cooling outputs function in the same manner as a standard chamber, except they are controlling fluid temperature instead of air.

### **TSB Chambers**

When the chamber event is turned on, the fluid system pumps are started in order to keep fluid flowing through the system to condition the test product. Some smaller TSB's merely have mixers in the bath to promote flow over the heaters and evaporator mounted in the baths. The fluid is heated and cooled as it flows across the heater and heat exchanger much like the air across the heater and evaporator in a typical chamber.

For TSB's with fluid pumps, the fluid system is equipped with safeties that insure that fluid is flowing through the system prior to allowing heating or cooling of the fluid to commence. This protects the system and components from damage that may occur by operating with no fluid flow. The heating and cooling outputs function in the same manner as a standard chamber, except they are controlling fluid temperature instead of air.

Hot baths are typically for heating only. They do not have any means of cooling the fluid. Cold baths may or may not have heaters in order to warm up and operate at elevated temperatures. Typically, cold baths are for cooling only.

### **Explosion Proof Chambers**

Division I, explosion proof chambers typically use "hot oil" systems as the means for heating the chamber. Division I explosion proof classifications require that no component, even upon failure, can ignite the flammable substance present. Electric heaters can short or rupture in a failure condition thus causing an explosion. Also, the surface temperature of the heaters is critical to safety. No portion of the heater surface can operate over 80% of the auto-ignition temperature of the flammable material as defined by Article 500 of the NEC.

Hot oil systems are equipped with independent temperature controls. These control devices will maintain the fluid at a preset temperature and/or prevent it from exceeding the maximum allowed operating temperature. The chamber temperature control will then cycle solenoids to control the flow of the fluid into a heating coil in the chamber, thus heating the air. Since the fluid is maintained at a safe temperature, even if the coil were to rupture, there is no source of ignition present.

**4.6.1 Fluid System Failures and Corrective Actions**

SYMPTOM	PROBABLE CAUSES	CORRECTIVE ACTIONS
Low or no fluid flow.	Blockage in piping/closed valves.  Pressure relief valve bypassing fluid.  Pump failure.  Blown fuse.	Locate blockage and remove/open valves.  Check pump pressure. Adjust/replace relief valve.  Check pump shaft coupling. Check motor overload/reset. Worn pump. Replace/repair.  Replace fuse.

**4.6.2 LC Fluid System Logic Flow**

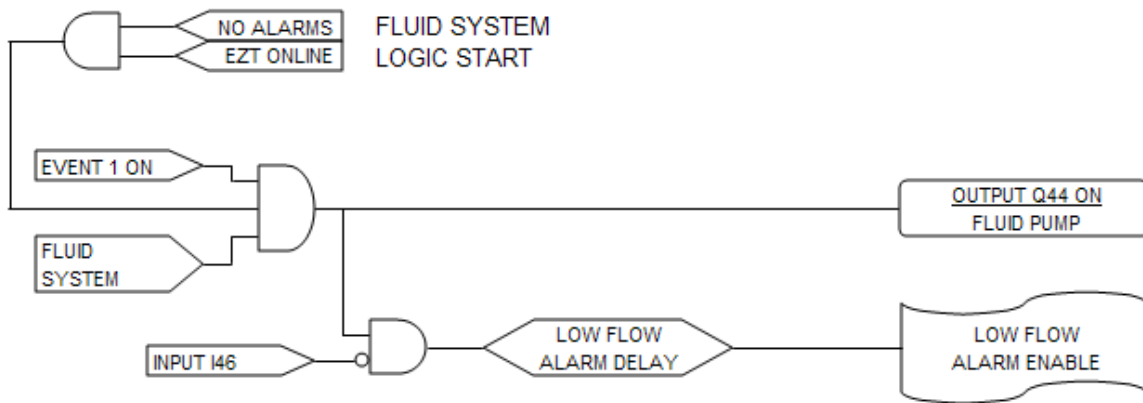

**4.7 Transfer Mechanism**

Transfer mechanisms are used on thermal shock chambers (DTS/VTS/TSB) to move a basket loaded with test product from one extreme temperature to another. These systems may utilize a single motor drive or one or more air cylinders to move the basket between the different temperature zones.

**Motor Operated Transfer Mechanism**

Motor operated transfer mechanisms are typically used on TSB's. They consist of a gear-motor drive with a lever arm attached to the output shaft. The motor direction is switched between clockwise and counterclockwise rotation in order to move the basket back and forth between the baths.

Limit switches are used to indicate each of the three positions, hot, cold and unload. The motor direction is determined by the current position of the basket, as indicated by which position switch is on, and the desired bath position set by the events. The motor runs until the limit switch for the desired position is met.

**Air Cylinder Operated Mechanism**

Air operated transfer mechanisms for DTS and VTS chambers are relatively simple. A single air cylinder is used to move the basket between the two available positions. Because of the design, the basket provides the mechanical stop for the cylinder. The cylinder continues to push on the basket, thus sealing the gasket surface to keep the hot and cold chambers separate. Limit switches are positioned on each end of the cylinder in order to identify the basket position.

TSB transfer mechanisms employing air cylinders are more sophisticated. They use two cylinders, one for up-and-down motion and the other for side-to-side motion. Limit switches are placed on each end of both cylinders to provide position information to the EZT. In order to transfer from one bath to the other, the basket is first raised into position. Once the basket is in the up position, the EZT then controls the other cylinder to move the basket left or right over the opposing baths. Once the basket is repositioned over either of the baths, it is then lowered into the bath.

**4.7.1 Transfer Mechanism Failures and Corrective Actions**

SYMPTOM	PROBABLE CAUSES	CORRECTIVE ACTIONS
Basket not transferring.	Limit switch failure. Basket already in position. Motor clutch slipping. Blown fuse (motor operated). Binding in transfer basket/mechanism. Loss of/low air pressure.	Check limit switches. Adjust/replace. Transfer to other position. Check/adjust clutch tension. Replace fuse. Check cable tension, pulleys, cylinder guides, etc. for wear. Adjust/repair. Supply proper air pressure. Check pressure regulator/adjust.
Basket not transferring to proper position.	Limit switch failure. Motor leads reversed. Air lines to cylinder reversed.	Verify limit switch operation. Swap motor leads. Swap air lines.



**4.7.2 Transfer System Logic Flow**

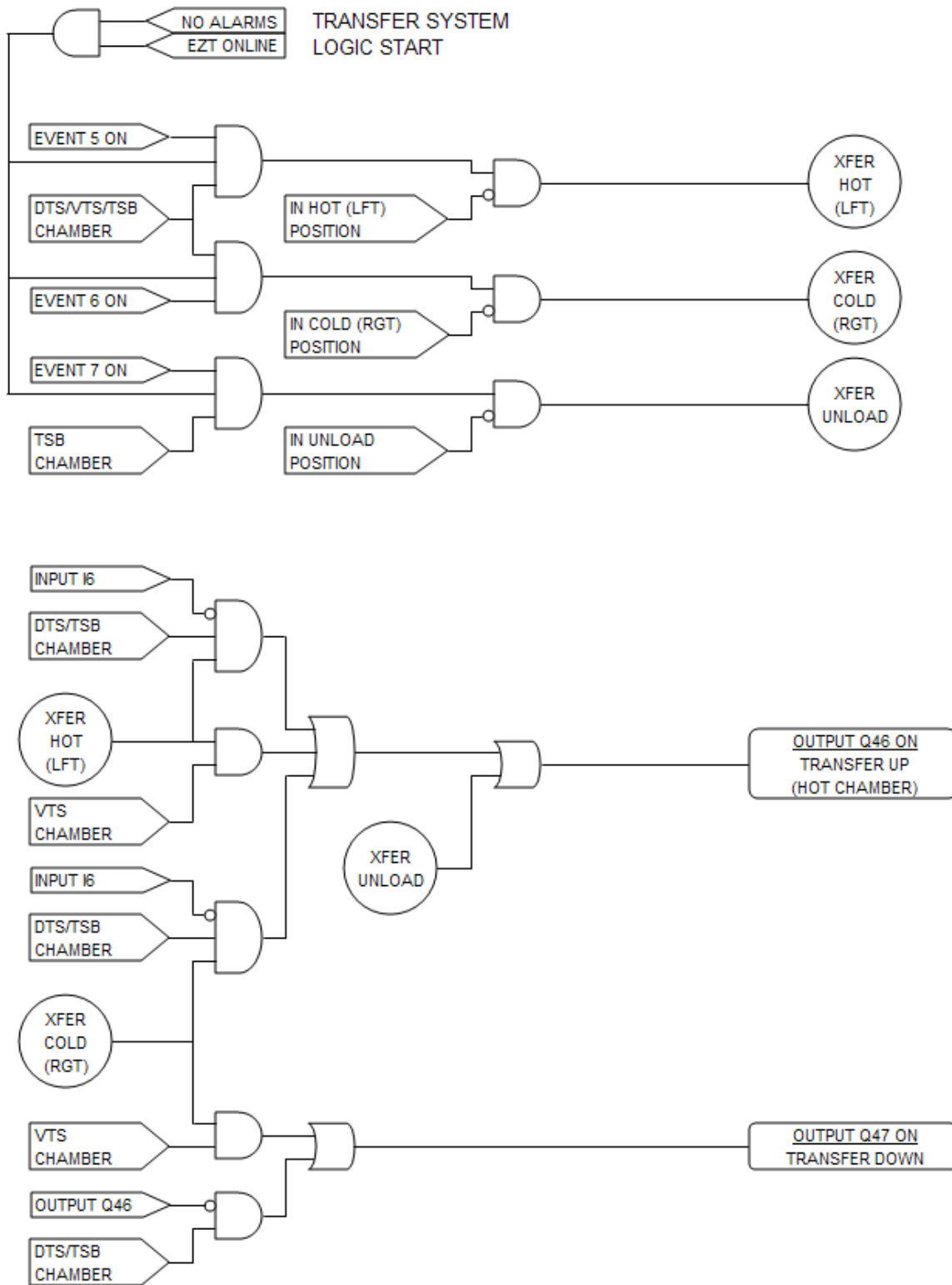

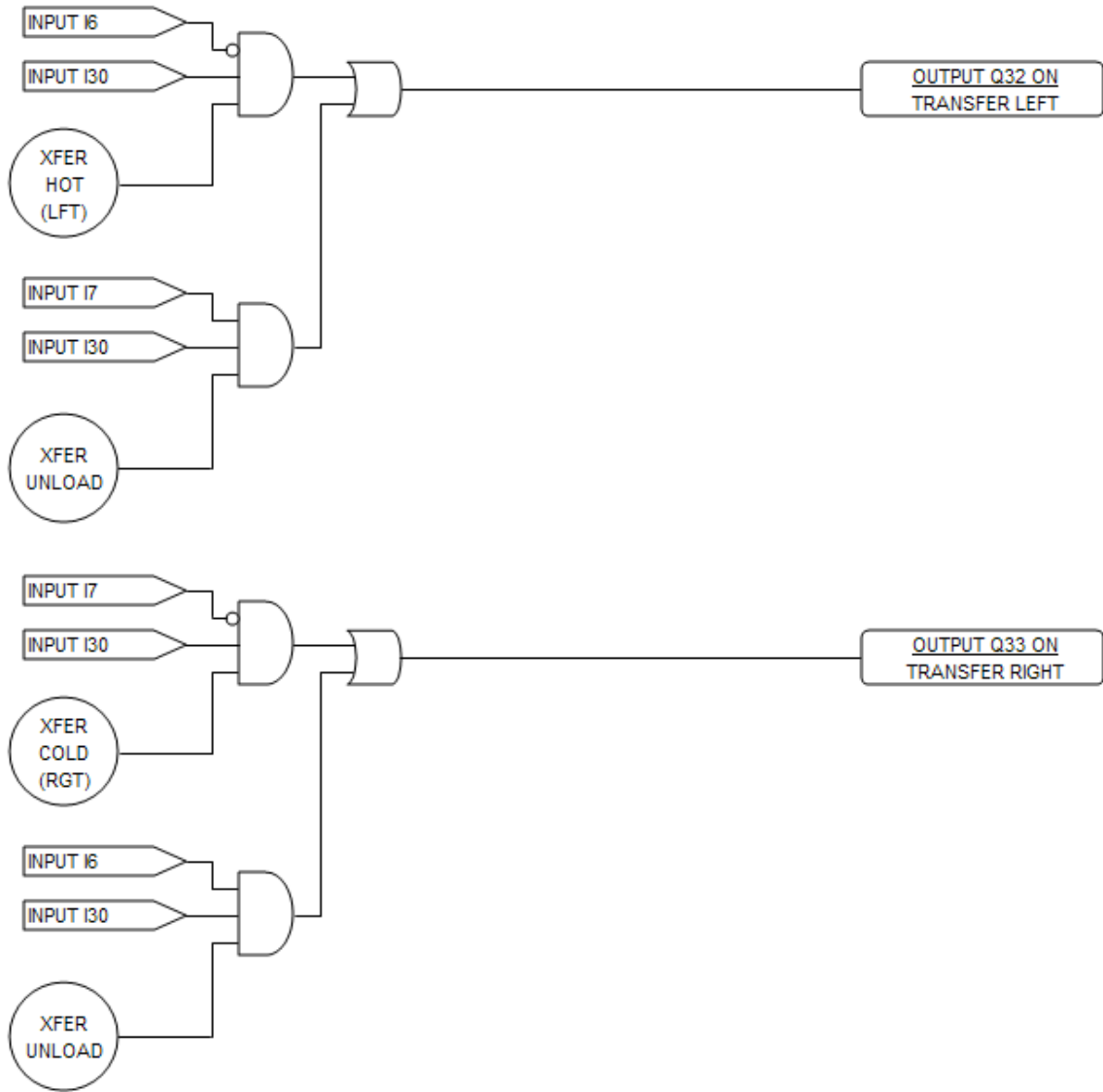

## 5. Remote PC Communication Problems

This section covers troubleshooting basics for user communications to the EZT. This is for PC to EZT communications, not internal communication between EZT components. The user communication capabilities are enabled from the “Web Server/Modbus/VNC” settings screen under the chamber setup menu.

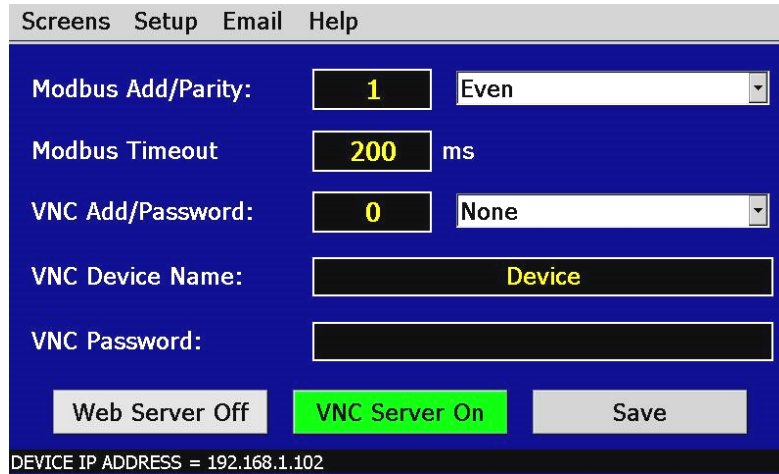

**Figure 5-1 Web Server/Modbus/VNC Communication Settings**

 For more detailed information on communication format, commands and functionality of the 232/485 serial interfaces, see the EZT-570i User Communication Reference Manual.

 **When connecting remote devices to the EZT’s communication ports, make sure that the equipment is properly grounded as required by the manufacturer’s instructions with a good earth ground. Poor site earths can introduce electrical noise and transient voltages into the communication wiring resulting in poor performance or damage to equipment.**

### 5.1 Serial Communications Troubleshooting

The EZT-570i allows a user to remote monitor and control chamber operations over an RS232 or RS485 communications connection. Only one may be used at a time. The connection type is enabled from the “CECP Serial Mode” screen.

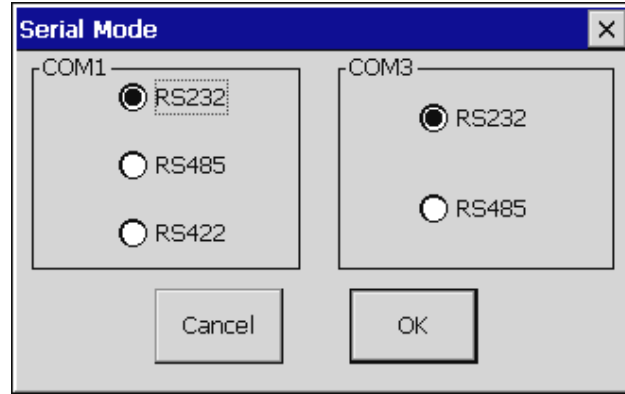

**Figure 5-2 Serial Port Mode Settings**

The CECP settings are accessed through the “Calibrate Touch Screen” menu item under system maintenance by selecting “Calibrate Touch”. You can then select the “Serial” mode icon to access the port settings. COM3 is utilized for user communications. Using the “radio button” selections, it is possible to select the port mode, RS232 or RS485.

The Modbus settings in the EZT allow the controller address and parity of the communications protocol to be changed. When communicating with a PC, the PC and the EZT settings must match in order for the communications connection to operate. The EZT is set with a default address of 1 and Even parity. Even parity is required when using CSZ EZ-View software to communicate with the EZT. The baud rate, data bits and stop bits of the serial interface are fixed at 9600 baud, 8 data bits and 1 stop bit. These settings are fixed and can not be changed.

**Table 5-1 Common Serial Communication Problems and Corrective Actions**

SYMPTOM	PROBABLE CAUSES	CORRECTIVE ACTIONS
EZT not responding to commands from PC.	Wrong slave address.  Wrong parity setting.  Wrong serial port mode setting.  Wrong communication port settings in PC or wrong command format.  EZT timeout setting too low.  Improper or loose connection.	Use slave address set in EZT or change EZT slave address to match.  Use parity setting in EZT or change EZT parity to match.  Verify serial connection used and set mode setting to match (RS232/RS485).  Verify proper protocol used (Modbus) Verify proper serial port settings used in PC.  Increase EZT timeout setting and/or slow down PC communication rate.  Check cables and wiring for loose or damaged connections. Verify proper connection polarity (null-modem cable connection for RS232).

**5.1.1 CSZ EZ-View Software**

EZ-View is a SCADA and configuration package for Cincinnati Sub-Zero EZT-570i controllers. Connection to controllers is accomplished via an RS232 (single) or RS485 (one to many) connection. This allows for up to 20 EZT-570i controlled chambers to be connected to a single PC using RS485.

EZ-View requires the use of serial port #1 (COM1) on the computer it is installed on. EZ-View does not allow modifications to the port number. Thus, this port must be available for EZ-View to operate. EZ-View must be configured for the chambers attached to the system prior to use. The "Controller Labels/Activation" menu under the "Setup" menu allows the user to add EZT controllers attached to the PC. EZT-570i series controllers are enabled (turned on) sequentially starting with address 1 through 20 which must match the address entered in each EZT-570i. Each EZT must also have its parity set to "Even" in order for EZ-View to communicate with it.

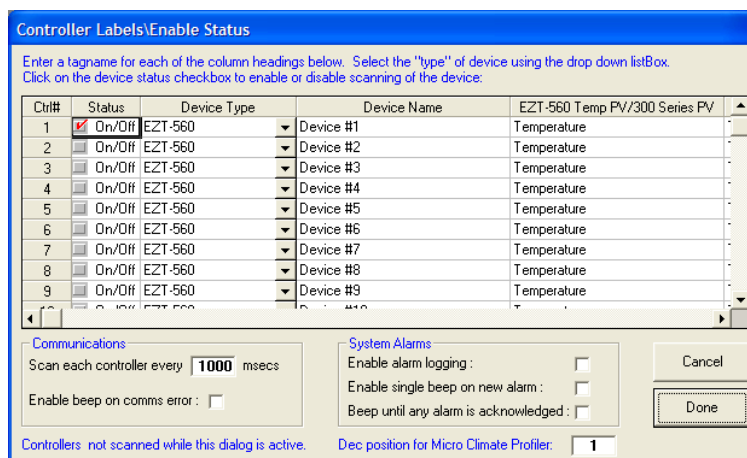

 **Controllers must be enabled in order. If a controller is skipped, it will not cause a direct communication error; however, the communications may not take place properly. With a controller skipped in the list, it can cause control data to be sent to the wrong controller**

**Table 5-2 Common EZ-View Start-up Problems and Corrective Actions**

SYMPTOM	PROBABLE CAUSES	CORRECTIVE ACTIONS
EZ-View communication error: "Control Address #, Device did not respond in 1 sec.	<p>Wrong slave address at EZT.</p> <p>Wrong parity setting at EZT.</p> <p>EZT not connected to serial port #1 of the PC.</p> <p>Wrong communication port mode on EZT.</p> <p>EZT timeout setting too low.</p> <p>Improper or loose connection.</p>	<p>Set EZT address to match controller number in EZ-View.</p> <p>Set EZT parity to "Even".</p> <p>Verify PC serial port used/connect to COM1.</p> <p>Verify proper serial port mode for connection used (RS232/485).</p> <p>Increase EZT timeout setting and/or slow down EZ-View scan rate.</p> <p>Check cables and wiring for loose or damaged connections. Verify proper connection polarity (null-modem cable connection for RS232).</p>

**5.2 GPIB Communications Troubleshooting**

The GPIB communication option is provided through the use of ICS's Model 4899 GPIB-to-Modbus Controller. The 4899 is an IEEE 488.2 compatible GPIB device that can control Modbus slave devices. It accepts simple GPIB bus commands that are used to create Modbus RTU packets that are transmitted serially to the Modbus slave devices, in this case, the EZT.

When this option is provided, it is connected to the EZT's RS485 serial connection. For the GPIB interface to be used, the EZT must have its serial port mode setting for COM3 set to RS485. If the serial port is not set for RS485, the GPIB interface will be unable to communicate with the EZT and communications will not be able to take place.



**Table 5-3 Common GPIB Communication Problems and Corrective Actions**

SYMPTOM	PROBABLE CAUSES	CORRECTIVE ACTIONS
GPIB interface not responding to read/write commands.	4899 power turned off. Wrong bus address. Missing termination character.	Turn 4899 power switch on. Verify 4899 GPIB bus address. Use proper termination character (default is LF).
Not reading data from EZT.	Read command sent to quickly after write command. 4899 serial timeout set to short. Wrong communication port mode on EZT. EZT timeout setting too low. Improper or loose connection.	Slow down communication rate between write/read commands to allow EZT time to respond. Set 4899 serial timeout to higher value. Use "D ####" command where #### = timeout in milliseconds. Verify proper serial port mode for connection used (RS232/485). Increase EZT timeout setting and/or slow down PC communication rate. Check cables and wiring for loose or damaged connections. Verify proper polarity.

### 5.3 Ethernet Communications Troubleshooting

The EZT-570i provides the ability to remotely control and monitor chamber operations over a network. To connect the EZT-570i to a network, connect the EZT's Ethernet port to an available network port using a standard CAT5 cable connection. The EZT will be automatically assigned an IP address via the network's DHCP server.

In order for the IP address to be assigned; however, power to the EZT must be cycled while the EZT is connected to the network. The IP address is assigned to the EZT during its boot sequence. The EZT indicates network communication activity via the red "COM" indicator LED on the front of the HMI. When the EZT is connected to a network, this indicator will flash to show network activity. Remember that even though the light may be flashing to indicate network activity, it does not mean that the EZT is part of the network. To be part of the network, it must have a valid IP address which is only assigned during boot.

The EZT provides control and monitoring interface using VNC. VNC viewers are available for free for most operating systems including Windows, MAC, Unix, etc. The monitor only interface is provided on a web page that contains the EZT operating information via the EZT's web server.

To use either interface, you must use the assigned IP address to access the EZT-570i. To obtain the correct IP address, go to the "Web Server/Modbus/VNC" screen under the chamber setup menu. Enter the IP address in your VNC client server or as the web page address in your web browser. When using the web browser connection, be sure to complete the address as shown in order to display the web page: <http://IPaddress/ezt.html> (from example address in Figure 5.1, <http://192.168.1.102/ezt.html>).

**Table 5-4 Common Ethernet Communication Problems and Corrective Actions**

SYMPTOM	PROBABLE CAUSES	CORRECTIVE ACTIONS
Web page not updating.	Connection to EZT lost. Page update period not elapsed.	Check EZT connection to intranet. Wait 30 seconds or press refresh button on web browser.
Can not open web page in web browser.	Web server disabled. IP address entered incorrectly. Invalid IP address.	Enable web server on "Web Server/Modbus/VNC" screen. Verify web address format. Cycle power to EZT. EZT must be connected to intranet upon application of power to receive a valid IP address.
VNC client not connecting to EZT.	VNC server disabled. IP address entered incorrectly. Invalid IP address.	Enable VNC server on "Web Server/Modbus/VNC" screen. Verify IP address format. Cycle power to EZT. EZT must be connected to intranet upon application of power to receive a valid IP address.
EZT not assigned valid IP address.	DHCP not set to automatically assign IP address on host.	Contact IT department for assistance.

## 6. User Interface (HMI) Troubleshooting

The EZT-570i's user interface is an embedded Windows CE device. Once powered up, it will follow a typical boot up sequence (similar to any PC running a Microsoft Windows product) and automatically start the EZT570i application. The EZT570i application is what provides the operating screens, loop views, trends, logging, etc., that the user can navigate through to change set points, create and run profiles, and so on.

The HMI and EZT570i application do not operate or perform any control tasks for the chamber. They are used for user input, information gathering and monitoring of chamber operations only. The information is exchanged over an RS232 serial communication link between the HMI and the EZT-570i's control module(CM) mounted on the electrical sub-panel. A failure of the HMI or EZT570i application will not cause the chamber to shut down. The CM will continue to operate the chamber under its last given instructions. In order to stop the chamber, power must be removed from the chamber.

**!** *If the HMI fails to boot up properly when power is restored to the chamber, the chamber will not begin operation. The HMI must boot up into the EZT570i application in order for the chamber to start. The CM will not start the chamber until it receives a signal from the HMI that it has booted up and the EZT570i application is running properly.*

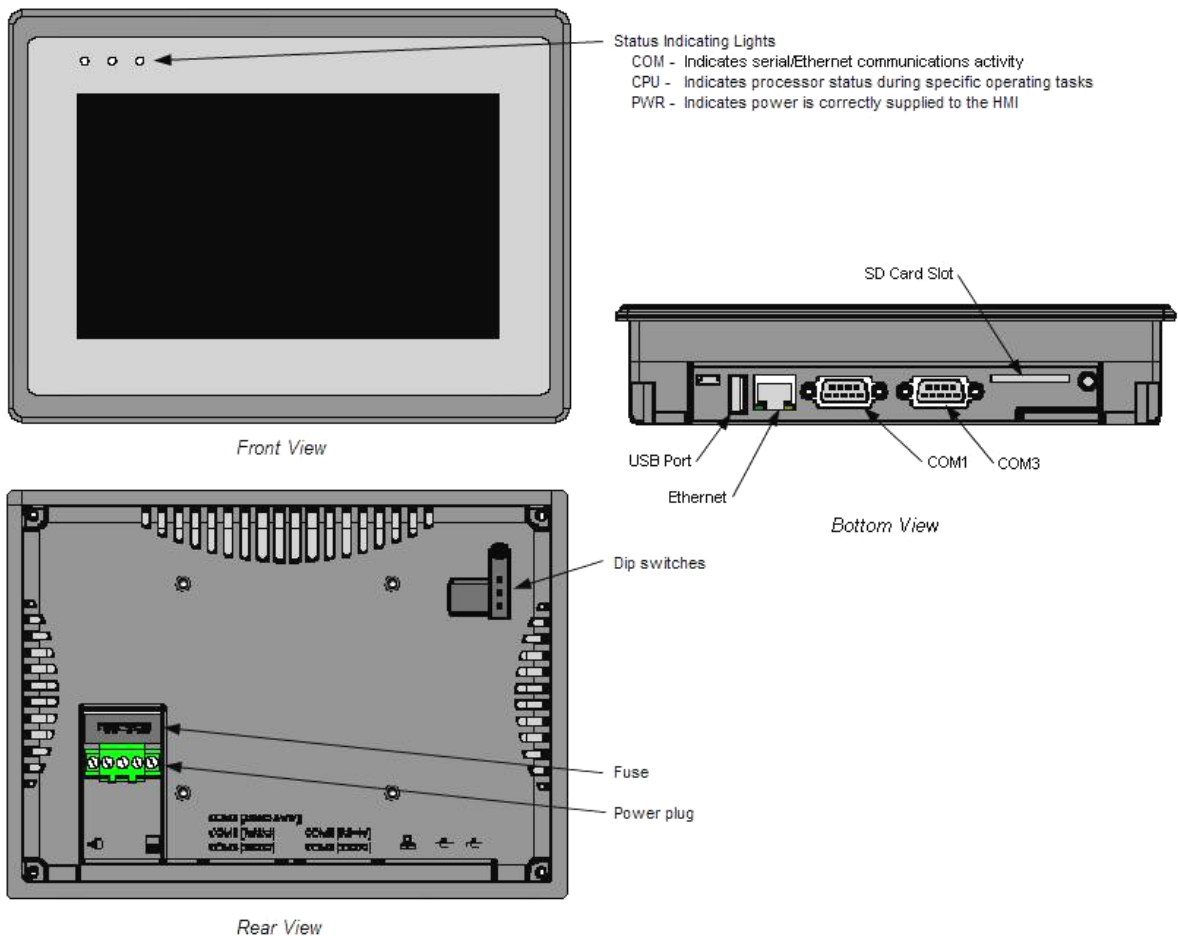



**6.1 HMI Troubleshooting and Corrective Actions**

SYMPTOM	PROBABLE CAUSES	CORRECTIVE ACTIONS
<b>1) <u>Black Screen</u></b>		
<p>"PWR" indicator is off. "CPU" indicator is off.</p>	<p>Power is off. Wrong polarity of power source. Blown Fuse on HMI.</p>	<p>Turn on power. Check/correct polarity of power source. Replace fuse.</p>
<p>"PWR" indicator is on. "CPU" indicator is off.</p>	<p>Screen saver is on. Bad backlight.</p>	<p>Touch screen to disable screen saver. Replace HMI.</p>
<p>"PWR" indicator is on. "CPU" indicator is on.</p>	<p>Power "glitch". Bad USB cable/damaged USB memory stick. Improperly inserted/damaged SD card. HMI hardware failure.</p>	<p>Cycle power to EZT. Check supply voltage. (must be 24 ± 1Vdc) Remove memory stick, replace USB cable. Verify SD card inserted properly. Replace SD card. Replace HMI.</p>
<b>2) <u>Blue Screen</u></b>		
<p>EZT570i application not starting.</p>	<p>SD card missing, improperly inserted or erased. Windows CE startup directory not properly configured.</p>	<p>Verify SD card is inserted properly. Check SD card for EZT570i operating files. Check/configure proper startup directory. (see Section 6.1.1)</p>
<b>3) <u>Communications Error</u></b>		
<p>"Error during write to controller. Check cable or setup/wiring." message displayed at startup.</p>	<p>Control module not loaded with chamber control program. Communication wiring between HMI and control module not properly connected. Serial port not set up properly on HMI. Control module communication adapter (port 2) not seated properly on CM/damaged.</p>	<p>Verify/load proper program to control module. Both "PWR" and "RUN" LED's lit on CM. Check wiring/connections. Correct/repair. Verify/correct serial port 1 mode on HMI. (see Section 6.1.2) Check connection between adapter and control module. Replace adapter (port 2).</p>
<p>"Comm alm at PLC. Check Cable."</p>	<p>Communication wiring between HMI</p>	<p>Check wiring/connections.</p>

SYMPTOM	PROBABLE CAUSES	CORRECTIVE ACTIONS
alarm message.	<p>and control module not properly connected.</p> <p>Electrical noise in system or remote PC communicating too fast with EZT.</p>	<p>Correct/repair.</p> <p>Check for proper shielding of communication wiring.</p> <p>Turn off electrically noisy devices.</p> <p>Disconnect remote PC or slow down communication rate from remote PC. (minimum 500ms scan rate)</p>
<b>4) <u>Screen Locked Up</u></b>		
Screen does not respond to touch.	<p>Touch screen out of calibration.</p> <p>VNC server not properly disconnected after previous access via remote PC.</p> <p>HMI operating temperature exceeded.</p> <p>CE operating system locked up.</p> <p>Touch screen failure.</p>	<p>Calibrate touch screen. (see Section 6.1.3)</p> <p>Restart VNC client at PC and verify operation. Shutdown VNC client to regain touch screen operation</p> <p>Ambient temperature around HMI must be between 0°C (32°F) and 45°C (113°F). Turn off EZT. Bring ambient temperature to within allowable range.</p> <p>Cycle power.</p> <p>Replace HMI.</p>

**6.1.1 Configure Windows CE Startup Directory**

The startup directory must be stored in the “NORFlash” directory in the HMI. This area is backed up to flash memory so it is retained when power is removed, and is automatically started once the boot sequence has been completed on power up. To check the startup directory, touch the thin gray bar at the bottom of the screen to display the start menu. Touch the “Start” button and select “Programs” and then “Windows Explorer”.



**Figure 6-1 Windows Start Menu**

From “My Computer” open the “NORFlash” directory. The NORFlash directory may contain several folders and/or files; however, we are only concerned with the “Startup” folder. If the startup folder does not exist, then it must be created. If the startup folder does exist, open the folder and make sure there is a shortcut to “EZT570i” in the folder. If it is not, then it must be added.

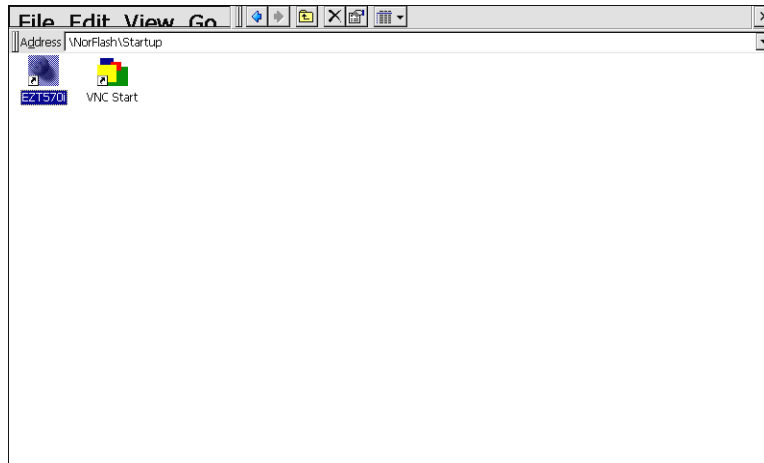

**Figure 6-2 NORFlash Directory**

The SD card holds a copy of the startup folder needed for proper operation. To replace either the missing folder or shortcut, copy the startup folder from the SD card to the NORFlash directory. To do so, open the storage card folder from “My Computer”. Touch the “Startup” folder to select it and then select “Copy” from the “Edit” menu. Return to the NORFlash directory and then select “Paste” from the “Edit” menu to paste the startup folder into the NORFlash directory. Cycle power to the EZT so that it can perform its normal boot sequence.

**6.1.2 Configure Serial Port 1 Mode**

Serial port 1, of the HMI, is used to communicate with the control module (CM). This is a three wire, RS232 serial link. In order for the link to operate properly, the serial port on the HMI must be set for RS232. If the serial port is not set properly, the EZT-570i application will not start and will remain on the splash screen. The “hour glass” will continue to turn and the “COM” LED on the HMI will flash as it tries to communicate with the CM.



**Figure 6-3 Write Error on Boot**

To check the serial port settings, power down the EZT. Remove the SD card from the bottom of the HMI and turn the power back on. Allow the HMI to boot up to the Windows desktop. Insert the SD card back into the bottom of the HMI. Touch the small gray bar at the bottom of the screen to open up the start menu. Press the “Start” button and select “CECP” from the “programs” menu.

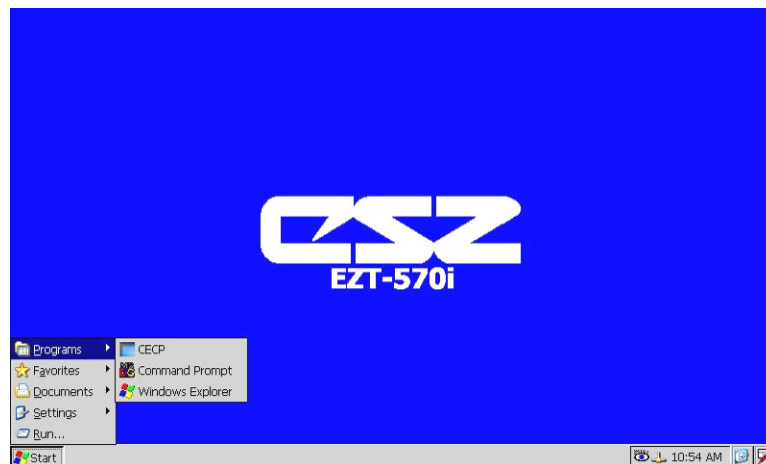

**Figure 6-4 Windows Start Menu**

Once the CECP utility window is shown, touch the “Serial” port icon to access the serial port settings.



**Figure 6-5 CECP**

COM1 should be set for RS485. COM3 is used for remote PC communications and its mode does not affect the communications between the HMI and control module.



**Figure 6-6 Serial Port Settings**

Set the serial port mode for COM1 to RS232 by touching the “radio button” next to the RS232 mode selection. Once selected, press the “OK” button to close the serial mode window. Press the “Quit” icon to exit the CECP utility and cycle power to the EZT and allow it to boot up normally.

### 6.1.3 Touch Screen Calibration

If the touch screen is severely out of calibration it can appear as if the HMI is “locked-up”. It may not respond to touch or will make it impossible to accurately select items in order to navigate to the normal screen calibration menu. If this occurs, there are two methods for correcting the screen’s calibration. The first one requires access to the dip switches on the back of the HMI, the other requires the use of a USB compatible mouse.

#### 6.1.3.1 Dip Switch Calibration Procedure

To begin, turn power off to the EZT. Gain access to the rear of the HMI and locate the dip switches on the upper right rear corner of the HMI behind a black rubber plug. Set dip switch 1 to the “on” (up) position. Restore power to the EZT. Allow the HMI to follow its normal boot sequence. Once the Windows CE image is loaded, the display will automatically start the touch screen calibration routine. Using a stylus, or the tip of a plastic pen cap, touch and hold on the center of each point marked by the crosshairs on the screen.



**Do not use any metal or sharp edged instruments on the screen or permanent damage to the screen may result.**

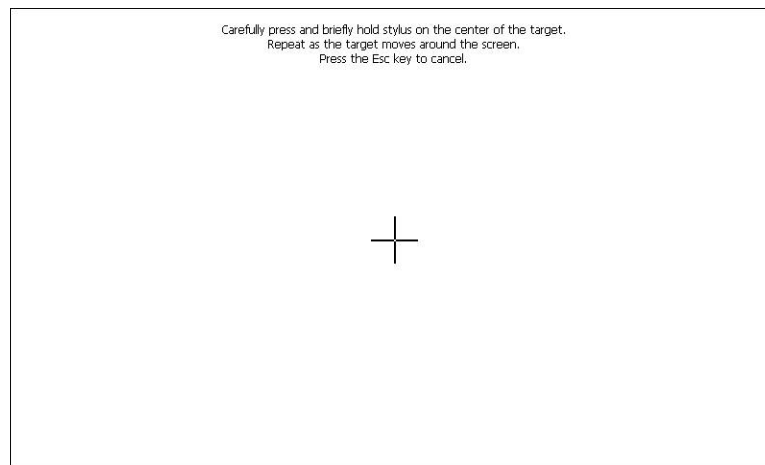

**Figure 6-7 Touch Calibration Screen**

Once all points have been measured, touch anywhere on the screen to accept the settings and complete the calibration routine. The display will continue its boot up sequence and start the EZT570i application. Set dip switch 1 off.



**Dip switch one must be set to off or the calibration routine will start each time power is applied. This will prevent the chamber from resuming operation on a power failure without user intervention.**

**6.1.3.2 USB Mouse Calibration Procedure**

Begin by connecting a mouse to the EZT's USB port. Using the mouse, you can navigate the screen just like using a desktop PC. Begin by selecting "Chamber Setup" from the main setup menu.

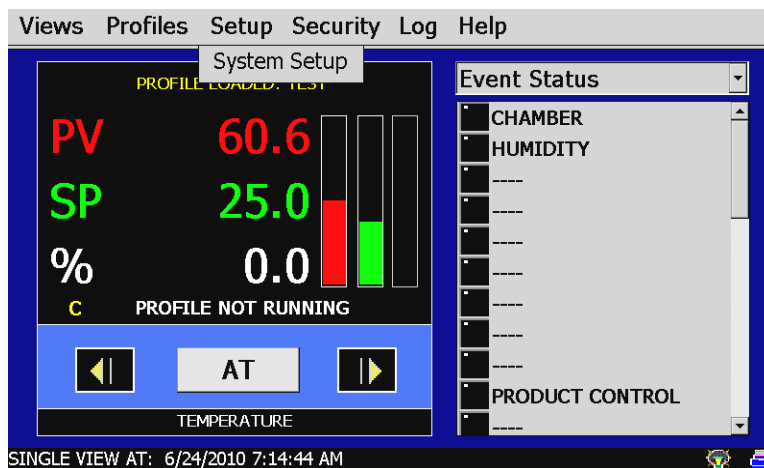

**Figure 6-8 Setup Menu Access**

Select "System Maintenance" from the setup menu.

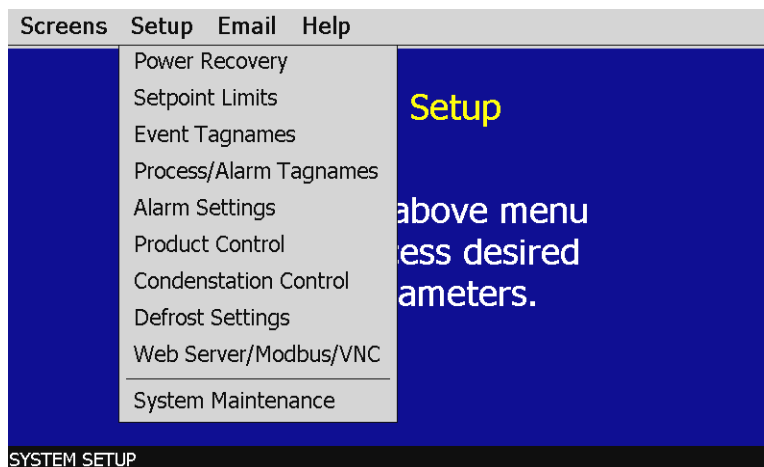

**Figure 6-9 Chamber Setup Menu Access**

You will be prompted with a message stated that "Maintenance mode will put system in offline condition! Continue?" Select "Yes".

From the setup menu, select "Calibrate Touch Screen".

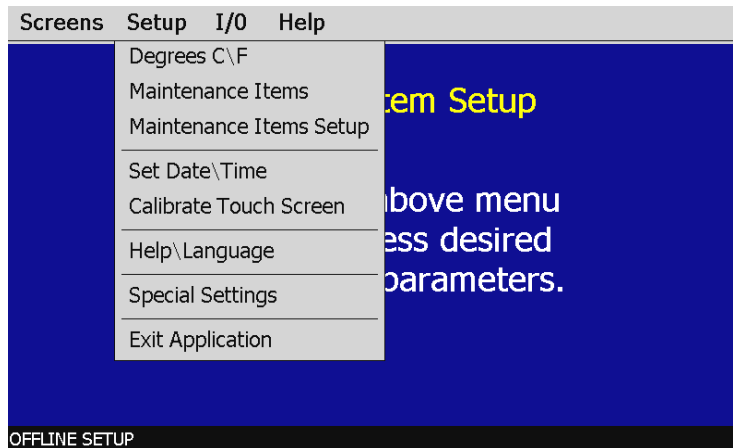

**Figure 6-10 System Maintenance Setup menu Access**

Press the “Yes” button to proceed to the CECP utility.

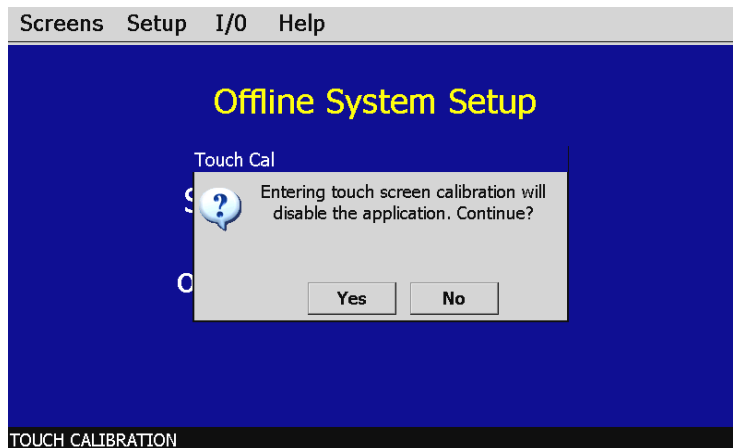

**Figure 6-11 Calibrate Touch**

Press the “Touch Screen” icon on the CECP settings screen and then press “Calibrate” to start the calibration process.

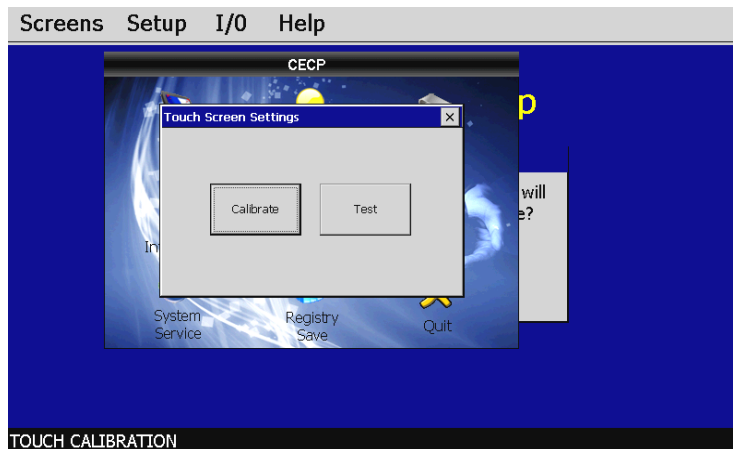

**Figure 6-12 CECP Touch Screen Settings**



Using a stylus, or the tip of a plastic pen cap, touch and hold on the center of each point marked by the crosshairs on the screen. Once all points have been measured, touch anywhere on the screen to accept the settings and complete the calibration routine.



**Do not use any metal or sharp edged instruments on the screen or permanent damage to the screen may result.**

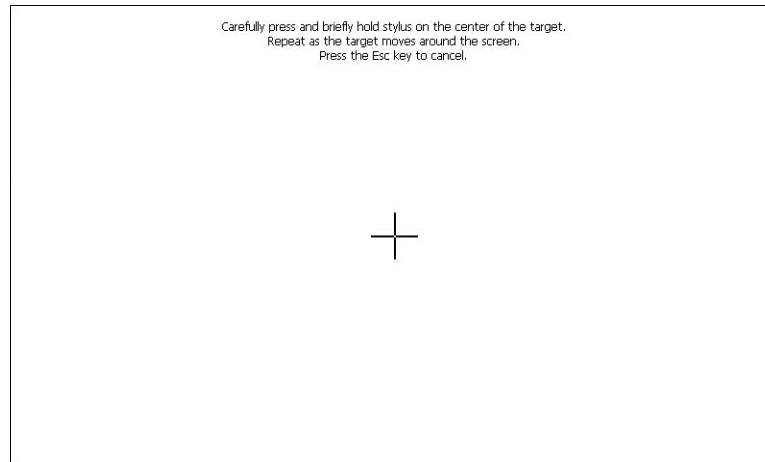

**Figure 6-13 Touch Calibration Screen**

Close the CECP settings window by pressing the “Quit” icon at the bottom right of the window. You can then return to the normal operating screens and resume operation of the chamber.

## 7. Deciphering EZT Input/Output (I/O) Operation

The inputs and outputs of the EZT-570i are predefined for specific functions on all standard chamber designs. This requires that certain inputs and outputs perform different functions based on the chamber type. This section covers all of the standard inputs and outputs of the system and their use based on the chamber type. For each input and output, an individual functional description is provided on how the input or output is used.

The control of the EZT outputs are also defined by which chamber events are enabled. The chamber events are predefined and their use varies according to the type of chamber and options present. The following table defines the standard use of the events.

**Table 7-1 Chamber Events**

EVENT	STANDARD	VTS (TSB)	DTS
1	CHAMBER	HOT CHAMBER (BATH ON)	LEFT CHAMBER
2	HUMIDITY	COLD CHAMBER	CENTER CHAMBER
3	AUX COOL	AUX COOL	AUX COOL
4	PURGE	PURGE	PURGE
5	ALTITUDE	XFR HOT	XFR LEFT
6	-	XFR COLD	XFR RIGHT
7	-	(XFR UNLOAD)	RIGHT CHAMBER
8	RC BLOWER	-	-
9	INITIATE DEFROST	INITIATE DEFROST	INITIATE DEFROST
10	PRODUCT CONTROL	PRODUCT CONTROL	PRODUCT CONTROL
11	REMOTE SETPOINT 1	REMOTE SETPOINT 1	REMOTE SETPOINT 1
12	REMOTE SETPOINT 2	REMOTE SETPOINT 2	REMOTE SETPOINT 2
13	REMOTE SETPOINT 3	REMOTE SETPOINT 3	REMOTE SETPOINT 3
14	REMOTE SETPOINT 4	REMOTE SETPOINT 4	REMOTE SETPOINT 4
15	REMOTE SETPOINT 5	REMOTE SETPOINT 5	REMOTE SETPOINT 5

The chamber loops are also predefined and their use varies according to the type of chamber and options present. The following table defines the standard use of the control loops.

**Table 7-2 Control Loops**

LOOP	STANDARD	VTS (TSB)	DTS
1	TEMPERATURE	HOT CHAMBER (BATH)	LEFT CHAMBER
2	DUT/HUMIDITY/ALTITUDE	COLD CHAMBER (BATH)	CENTER CHAMBER
3	DUT/ALTITUDE	DUT	RIGHT CHAMBER
4	DUT	-	DUT LEFT BASKET
5	-	-	DUT RIGHT BASKET

**7.1 Standard Input Configuration**

INPUT	STANDARD CONFIGURATION	DUAL REFRIGERATION	DTS, VTS, TSB
I0000	CHAMBER LIMIT	SYSTEM 'A' HEATER LIMIT	
I0001	PRODUCT SAFETY		
I0002	MOTOR OVERLOAD	SYSTEM 'A' MOTOR OVERLOAD	
I0003	SYSTEM 1 PRESSURE SAFETY	SYSTEM 'A' PRESSURE SAFETY	
I0004	SYSTEM 1 DISCHARGE SAFETY	SYSTEM 'A' DISCHARGE SAFETY	
I0005	SYSTEM 2 PRESSURE SAFETY	SYSTEM 'B' PRESSURE SAFETY	
I0006	BOILER TEMPERATURE SAFETY		BASKET LEFT
I0007	BOILER LOW WATER SAFETY		BASKET RIGHT
I0030	HUMIDITY WATER RESERVOIR LEVEL	SYSTEM 'B' BOILER LO H2O SAFETY	BASKET UP
I0031	CARGOCAIRE FAULT	SYSTEM 1B PUMPDOWN SWITCH	BASKET DOWN
I0032	SYSTEM 1(A) PUMPDOWN SWITCH		
I0033	SYSTEM 1 OIL PRESSURE SAFETY	SYSTEM 'A' OIL PRESSURE SAFETY	
I0034	SYSTEM 1 PROTECTION MODULE	SYSTEM 'A' PROTECTION MODULE	
I0035	SYSTEM 2 DISCHARGE SAFETY	SYSTEM 'B' DISCHARGE SAFETY	
I0036	SYSTEM 2 OIL PRESSURE SAFETY	SYSTEM 'B' OIL PRESSURE SAFETY	
I0037	SYSTEM 2 PROTECTION MODULE	SYSTEM 'B' PROTECTION MODULE	
I0040	DEFROST PRESSURE CONTROL	SYS 'B' DEFROST TEMP SWITCH	
I0041	DEFROST TEMPERATURE SWITCH	SYS 'A' DEFROST TEMP SWITCH	
I0042	DOOR SWITCH		
I0043	EMERGENCY STOP		
I0044	FLUID SYSTEM TEMPERATURE SAFETY	SYSTEM 'B' HEATER LIMIT	
I0045	FLUID SYSTEM PRESSURE SAFETY	SYSTEM 'B' MOTOR OVERLOAD	TSB PUMP PRESSURE SAFETIES
I0046	FLUID SYSTEM FLOW SAFETY	SYSTEM 'B' BOILER TEMP SAFETY	TSB BATH LOW LEVEL (OPTIONAL)
I0047	POWER FAILURE		

**Dual Refrigeration** refers to a refrigeration type selection of “tandem” or “redundant” meaning there are two duplicate refrigeration systems cooling the chamber.

### 7.1.1 Input Description of Use

- Chamber Limit (I0):* The chamber limit input is used to indicate that the chamber temperature safety has tripped. This input is active high, i.e., the input must be on in order for the alarm to be indicated. When active, the EZT shuts down the chamber until the alarm is acknowledged (silence button pressed on alarm monitor screen) and the input is no longer active (requires manual reset of chamber limit device).
- Product Safety (I1):* The product safety input is used to indicate that the redundant product safety has tripped (if equipped). This input is active high, i.e., the input must be on in order for the alarm to be indicated. When active, the EZT shuts down the chamber until the alarm is acknowledged (silence button pressed on alarm monitor screen) and the input is no longer active (requires manual reset of product safety).
- Motor Overload (I2):* The motor overload input is used to indicate that a motor overload relay has tripped off due to a motor overload condition (if equipped). This input is active high, i.e., the input must be on in order for the alarm to be indicated. When active, the EZT shuts down the chamber until the alarm is acknowledged (silence button pressed on alarm monitor screen) and the input is no longer active (requires manual reset of motor overload).
- It may also be used to indicate a failure of a VFD if one is used to control motor speed. If the VFD is at fault, check the manufacturer's manual for troubleshooting and diagnostic information. Typically, pressing the stop/reset button on the drive should clear the fault condition.
- Sys1 Hi/Lo Pressure Safety (I3):* The system 1 hi/lo pressure safety input is used to indicate that the system 1 compressor has exceeded its high or low pressure operating range. This input is active low, i.e., the input must be off in order for the alarm to be indicated. When active (input off), the EZT shuts down the chamber until the alarm is acknowledged (silence button pressed on alarm monitor screen) and the input is on (requires manual reset of high pressure safety).
- Sys1 Discharge Thermostat (I4):* The system 1 discharge thermostat input is used to indicate that the system 1 compressor discharge temperature has exceeded the maximum operating range (if equipped). This input is active low, i.e., the input must be off in order for the alarm to be indicated. When active (input off), the EZT shuts down the chamber until the alarm is acknowledged (silence button pressed on alarm monitor screen) and the input is on (automatically resets after allowed to cool down).

## ***EZT-570i Technical Manual***

---

- Sys2 Hi/Lo Pressure Safety (I5):*** The system 2 hi/lo pressure safety input is used to indicate that the system 2 compressor has exceeded its high or low pressure operating range. This input is active low, i.e., the input must be off in order for the alarm to be indicated. When active (input off), the EZT shuts down the chamber until the alarm is acknowledged (silence button pressed on alarm monitor screen) and the input is on (requires manual reset of high pressure safety).
- Boiler Thermostat (I6):*** The boiler high temperature thermostat input is used to indicate that the boiler has overheated. This input is active low, i.e., the input must be off in order for the alarm to be indicated. When active (input off), the EZT shuts down the chamber until the alarm is acknowledged (silence button pressed on alarm monitor screen) and the input is on (requires manual reset of thermostat).
- Boiler Low Water (I7):*** The boiler low water input is used to indicate that the boiler is low on water. This input is active low, i.e., the input must be off in order for the alarm to be indicated. When active (input off), the EZT shuts down the chamber until the alarm is acknowledged (silence button pressed on alarm monitor screen).
- The low water safety has a built in delay to prevent the activating of the alarm until the boiler has been given sufficient time to fill (30 minute delay upon turning on the humidity event). If the boiler has not filled up in the allotted time, the alarm will sound. Once the boiler has reached the proper operating level, the alarm will sound immediately upon loss of level.
- Water Reservoir Low (I30):*** The water reservoir low input is used to indicate that the humidity system water reservoir is low on water (if equipped). This input is active low, i.e., the input must be off in order for the alarm to be indicated. When active (input off), the EZT will sound the alarm to bring operator attention to the chamber. The alarm will sound until acknowledged (silence button pressed on system status screen). This is a notification alarm only and does not shut down the chamber.
- If the chamber has the humidity option, but not the low water reservoir, this input must be wired to VCC. If not, the low water alarm will always be present. Jumping this input out prevents the alarm.
- Cargocaire Fault (I31):*** The dehumidifier system fault input is used to indicate that there is a problem with the Cargocaire (if equipped). This input is active high, i.e., the input must be on in order for the alarm to be indicated. When active (input on), the EZT shuts down the chamber until the alarm is acknowledged (silence button pressed on alarm monitor screen) and the input is off (requires manual reset/service of dehumidifier unit).
- Sys1 Pumpdown Switch (I32):*** This input is a control input for pumpdown (if equipped). There is no user indication for this input. When the refrigeration system

requires pumpdown, this input is wired to a low pressure switch on the suction line of system 1 compressor. When the pressure rises, the switch closes and turns on the input.

The EZT then turns on the system 1 compressor output (Q3) until the input turns off. When the input turns off, indicating that the compressor has pumped down, the EZT turns off the system 1 compressor output. During pumpdown, the system 1 solenoids output (Q30) remains off in order to isolate the low side of the refrigeration system so it can be pumped down.

*Sys1 Oil Pressure Safety (I33):* The system 1 oil pressure safety input is used to indicate that the system 1 compressor oil pressure is below the proper operating range (if equipped). This input is active low, i.e., the input must be off in order for the alarm to be indicated. When active (input off), the EZT shuts down the chamber until the alarm is acknowledged (silence button pressed on alarm monitor screen) and the input is on (requires manual reset of oil pressure safety).

*Sys1 Protection Module (I34):* The system 1 compressor protection module input is used to indicate that the system 1 compressor protection module has detected an improper phase condition/loss or the compressor motor windings have overheated (if equipped). This input is active low, i.e., the input must be off in order for the alarm to be indicated. When active (input off), the EZT shuts down the chamber until the alarm is acknowledged (silence button pressed on alarm monitor screen) and the input is on (automatically resets after built-in timeout period).

*Sys2 Discharge Thermostat (I35):* The system 2 discharge thermostat input is used to indicate that the system 2 compressor discharge temperature has exceeded the maximum operating range (if equipped). This input is active low, i.e., the input must be off in order for the alarm to be indicated. When active (input off), the EZT shuts down the chamber until the alarm is acknowledged (silence button pressed on alarm monitor screen) and the input is on (automatically resets after allowed to cool down).

*Sys2 Oil Pressure Safety (I36):* The system 2 oil pressure safety input is used to indicate that the system 2 compressor oil pressure is below the proper operating range (if equipped). This input is active low, i.e., the input must be off in order for the alarm to be indicated. When active (input off), the EZT shuts down the chamber until the alarm is acknowledged (silence button pressed on alarm monitor screen) and the input is on (requires manual reset of oil pressure safety).

*Sys2 Protection Module (I37):* The system 2 compressor protection module input is used to indicate that the system 2 compressor protection module has detected an improper phase condition/loss or the compressor

motor windings have overheated (if equipped). This input is active low, i.e., the input must be off in order for the alarm to be indicated. When active (input off), the EZT shuts down the chamber until the alarm is acknowledged (silence button pressed on alarm monitor screen) and the input is on (automatically resets after built-in timeout period).

***Sys1 Defrost Pressure Switch (I40):*** This input is a control input for defrost (if equipped). There is no user indication for this input. When equipped with defrost, this input is wired to a pressure switch on the discharge of system 2 compressor. This input is used to control system 1 cooling of system 2. When the input is on, system 1 will cool the cascade condenser for system 2. When the input is off, the EZT turns off cooling to the cascade by either turning off the cascade cooling solenoids (Q43) for large HP defrost or by turning off system 1 compressor for standard defrost.

***Sys1 Defrost Thermostat (I41):*** This input is a control input for defrost (if equipped). There is no user indication for this input. When equipped with defrost, this input is wired to a thermostat on the suction line of the cooling coil. When the refrigeration system is in defrost, this input is used to begin the termination sequence for defrost by signaling that the coil defrost temperature has been met.

When the input first turns on, the EZT will begin the 15 minute countdown to terminate defrost. The thermostat is typically set for about 10°C (50°F). After defrost times out, the prechill step begins. The refrigeration system will begin to cool the coil. Once the thermostat sees the coil drop below the set point, a 60 second prechill timer will begin. At the end of 60 seconds, the chamber will return to normal operation.

If the control loop is not calling for 100% cooling, the prechill timer will begin its 60 second countdown regardless of the suction line temperature.

***Door Switch (I42):***

The door switch input is used to indicate if the chamber door is open or closed (if equipped). The "door ajar" status will be displayed on the system status monitor screen. If the door control option is enabled, the EZT will shut down the chamber when the door is opened. This input is active low, i.e., the input is off to indicate an "open door" status.

If the door alarm option is enabled, a "door open" alarm will appear on the alarm monitor screen and the audible alarm will sound if the door is open when the chamber is running.

***Emergency Stop (I43):***

The emergency stop input is used to indicate that the emergency stop has been activated (if equipped). This input is active high, i.e., the input must be on in order for the alarm to be indicated. When active (input on), the EZT shuts down the chamber until the alarm is acknowledged (silence button pressed on alarm

monitor screen) and the input is off (requires manual reset of E-Stop button).

*Fluid Temperature Safety (I44):*

The fluid system temperature safety input is used to indicate that the fluid temperature limit has been exceeded (LC chambers). This input is active high, i.e., the input must be on in order for the alarm to be indicated. When active (input on), the EZT shuts down the chamber until the alarm is acknowledged (silence button pressed on alarm monitor screen) and the input is off (requires manual reset of limit device).

*Fluid Pressure Safety (I45):*

The fluid system pressure safety input is used to indicate that the fluid system has exceeded maximum operating pressures (LC chambers). This input is active low, i.e., the input must be off in order for the alarm to be indicated. When active (input off), the EZT shuts down the chamber until the alarm is acknowledged (silence button pressed on alarm monitor screen) and the input is off.

*Fluid Flow Safety (I46):*

The fluid system flow safety input is used to indicate that the fluid system has proper flow (LC chambers). This input is active low, i.e., the input must be off in order for the alarm to be indicated. When active (input off), the EZT shuts down the chamber until the alarm is acknowledged (silence button pressed on alarm monitor screen) and the input is off.

The EZT has a built in time delay to disable the low flow alarm until the pump has had a chance to start and begin moving fluid (5 seconds). If the input does not turn on within the start delay period, the alarm will be activated.

*Power Failure(I47):*

The power failure input is used to indicate that there is a primary power failure to the chamber. When the chamber is equipped with a battery backup option for the control circuit, it allows the EZT to send out an alarm message over its network interface to alert operators of the power outage. When main power is restored, the EZT will automatically restart the chamber.



**7.1.1.1 Custom Input Description of Use (DTS, VTS, TSB)**

- Basket Left (I16):*** This control input is used to tell the EZT that the basket (DTS/TSB) is in the left position/hot bath. There is no user indication for this input.
- Basket Right (I17):*** This control input is used to tell the EZT that the basket (DTS/TSB) is in the right position/cold bath. There is no user indication for this input.
- Basket Up (I30):*** This control input is used to tell the EZT that the basket (VTS/TSB) is in the hot chamber/unload position. There is no user indication for this input.
- Basket Down (I31):*** This control input is used to tell the EZT that the basket (VTS/TSB) is in the cold chamber/down position. There is no user indication for this input.
- TSB Pump Pressure Safety (I45):*** The pump pressure safety input is used on TSB's to indicate that the hot or cold bath fluid pump has exceeded its maximum operating pressure. This input is active low, i.e., the input must be off in order for the alarm to be indicated. When active (input off), the EZT shuts down the chamber until the alarm is acknowledged (silence button pressed on alarm monitor screen) and the input is off.
- Bath Level Safety (I46):*** The bath level safety input is used on TSB's to indicate that a bath is low on fluid (if equipped with level sensors). This input is active high, i.e., the input must be on in order for the alarm to be indicated. When active (input on), the EZT will sound the alarm to obtain operator attention but will not shut down the chamber. The alarm will be shown on the system status monitor screen.

**7.1.1.2 Custom Input Description of Use (Dual Refrigeration)**

**Sys 'A' Hi/Lo Pressure Safety (I3):** The system 'A' hi/lo pressure safety input is used to indicate that the system 1A or system 2A compressor has exceeded its high or low pressure operating range. This input is active low, i.e., the input must be off in order for the alarm to be indicated. When active (input off), the EZT shuts down the chamber until the alarm is acknowledged (silence button pressed on alarm monitor screen) and the input is on (requires manual reset of high pressure safety).

**Sys 'A' Discharge Thermostat (I4):** The system 'A' discharge thermostat input is used to indicate that the system 1A or system 2A compressor discharge temperature has exceeded the maximum operating range (if equipped). This input is active low, i.e., the input must be off in order for the alarm to be indicated. When active (input off), the EZT shuts down the chamber until the alarm is acknowledged (silence button pressed on alarm monitor screen) and the input is on (automatically resets after allowed to cool down).

**Sys 'B' Hi/Lo Pressure Safety (I5):** The system 'B' hi/lo pressure safety input is used to indicate that the system 1B or system 2B compressor has exceeded its high or low pressure operating range. This input is active low, i.e., the input must be off in order for the alarm to be indicated. When active (input off), the EZT shuts down the chamber until the alarm is acknowledged (silence button pressed on alarm monitor screen) and the input is on (requires manual reset of high pressure safety).

**System 'B' Boiler Low Water (I30):** The system 'B' boiler low water input is only used when there are independent system plenums since this usually results in a boiler on each plenum. Thus, this input is used to indicate that the boiler on plenum 'B' is low on water. This input is active low, i.e., the input must be off in order for the alarm to be indicated. When active (input off), the EZT shuts down the chamber until the alarm is acknowledged (silence button pressed on alarm monitor screen).

The low water safety has a built in delay to prevent the activating of the alarm until the boiler has been given sufficient time to fill (30 minute delay upon turning on the humidity event). If the boiler has not filled up in the allotted time, the alarm will sound. Once the boiler has reached the proper operating level, the alarm will sound immediately upon loss of level.

**System 1B Pumpdown Switch (I31):** This input is a control input for pumpdown (if equipped). There is no user indication for this input. When refrigeration system requires pumpdown, this input is wired to a low pressure switch on the suction line of system 1B compressor. When the pressure rises, the switch closes and turns on the input.

The EZT then turns on the system 1B compressor output (Q46) until the input turns off. When the input turns off, indicating that the compressor has pumped down, the EZT turns off the system 1B compressor output. During pumpdown, the system 1B solenoids output (Q45) remains off in order to isolate the low side of the refrigeration system so it can be pumped down.

**Sys 'A' Oil Pressure Safety (I33):** The system 'A' oil pressure safety input is used to indicate that the system 1A or system 2A compressor oil pressure is below the proper operating range (if equipped). This input is active low, i.e., the input must be off in order for the alarm to be indicated. When active (input off), the EZT shuts down the chamber until the alarm is acknowledged (silence button pressed on alarm monitor screen) and the input is on (requires manual reset of oil pressure safety).

**Sys 'A' Protection Module (I34):** The system 'A' compressor protection module input is used to indicate that the system 1A or system 2A compressor protection module has detected an improper phase condition/loss or the compressor motor windings have overheated (if equipped). This input is active low, i.e., the input must be off in order for the alarm to be indicated. When active (input off), the EZT shuts down the chamber until the alarm is acknowledged (silence button pressed on alarm monitor screen) and the input is on (automatically resets after built-in timeout period).

**Sys 'B' Discharge Thermostat (I35):** The system 'B' discharge thermostat input is used to indicate that the system 1B or system 2B compressor discharge temperature has exceeded the maximum operating range (if equipped). This input is active low, i.e., the input must be off in order for the alarm to be indicated. When active (input off), the EZT shuts down the chamber until the alarm is acknowledged (silence button pressed on alarm monitor screen) and the input is on (automatically resets after allowed to cool down).

**Sys 'B' Oil Pressure Safety (I36):** The system 'B' oil pressure safety input is used to indicate that the system 1B or system 2B compressor oil pressure is below the proper operating range (if equipped). This input is active low, i.e., the input must be off in order for the alarm to be indicated. When active (input off), the EZT shuts down the chamber until the alarm is acknowledged (silence button pressed on alarm monitor screen) and the input is on (requires manual reset of oil pressure safety).

*Sys 'B' Protection Module (I37):* The system 'B' compressor protection module input is used to indicate that the system 1B or system 2B compressor protection module has detected an improper phase condition/loss or the compressor motor windings have overheated (if equipped). This input is active low, i.e., the input must be off in order for the alarm to be indicated. When active (input off), the EZT shuts down the chamber until the alarm is acknowledged (silence button pressed on alarm monitor screen) and the input is on (automatically resets after built-in timeout period).

*Sys 'B' Defrost Thermostat (I40):* This input is a control input for defrost (if equipped). There is no user indication for this input. When equipped with defrost, this input is wired to a thermostat on the suction line of the cooling coil. When the refrigeration system is in defrost, this input is used to begin the termination sequence for defrost by signaling that the coil defrost temperature has been met.

When the input first turns on, the EZT will begin the 15 minute countdown to terminate defrost. The thermostat is typically set for about 10°C (50°F). After defrost times out, the prechill step begins. The refrigeration system will begin to cool the coil. Once the thermostat sees the coil drop below the set point, a 60 second prechill timer will begin. At the end of 60 seconds, the chamber will return to normal operation.

If the control loop is not calling for 100% cooling, the prechill timer will begin its 60 second countdown regardless of the suction line temperature.

*System 'B' Heater Limit (I44):* This input is only used with independent system plenums. The input is used to indicate that the heater limit safety has tripped on plenum 'B'. This input is active high, i.e., the input must be on in order for the alarm to be indicated. When active, the EZT shuts down the chamber until the alarm is acknowledged (silence button pressed on alarm monitor screen) and the input is no longer active (requires manual reset of chamber limit device).

*System 'B' Motor Overload (I45):* This input is only used with independent system plenums. The input is used to indicate that a motor overload relay has tripped off due to a motor overload condition (if equipped) on plenum 'B'. This input is active high, i.e., the input must be on in order for the alarm to be indicated. When active, the EZT shuts down the chamber until the alarm is acknowledged (silence button pressed on alarm monitor screen) and the input is no longer active (requires manual reset of motor overload).

It may also be used to indicate a failure of a VFD if one is used to control motor speed. If the VFD is at fault, check the manufacturer's manual for troubleshooting and diagnostic information. Typically, pressing the stop/reset button on the drive should clear the fault condition.

*System 'B' Boiler Thermostat (I46):* The system 'B' boiler thermostat input is only used when there are independent system plenums since this usually results in a boiler on each plenum. Thus, this input is used to indicate that the boiler on plenum 'B' has overheated. This input is active low, i.e., the input must be off in order for the alarm to be indicated. When active (input off), the EZT shuts down the chamber until the alarm is acknowledged (silence button pressed on alarm monitor screen) and the input is on (requires manual reset of thermostat).

7.2 Standard Output Configuration

OUTPUT	STANDARD CONFIGURATION	DUAL REFRIGERATION	ALTITUDE	DTS, VTS, TSB
Q0000	AUDIBLE ALARM			
Q0001	MAXIMUM COOLING			
Q0002	AIR CIRCULATORS	SYSTEM 'A' CIRCULATORS	LOW SPEED FANS	COLD CHAMBER (DTS CENTER)
Q0003	SYSTEM 1(A) COMPRESSOR			
Q0004	SYSTEM 2(A) COMPRESSOR			
Q0005	CHAMBER LIGHT			
Q0006	WINDOW HEATER			
Q0007	PRODUCT LIMIT			
Q0030	SYSTEM 1(A) SOLENOIDS			
Q0031	MAXIMUM HEAT			MAX HEAT HOT CHAMBER/BATH (DTS LEFT)
Q0032	HUMIDITY SYSTEM			BASKET LEFT
Q0033	MAXIMUM HUMIDIFY			BASKET RIGHT
Q0034	DRY AIR PURGE			
Q0035	LOW RH/FROZEN COIL			MAX HEAT DTS RIGHT
Q0036	AUXILIARY COOLING SUPPLY			
Q0037	AUXILIARY COOLING CONTROL			
Q0040	RATE MASTER CONTROL	SYSTEM 'B' HEAT/COOL ENABLE		HOT CHAMBER (DTS RIGHT)
Q0041	MINIMUM HEAT/COOL ENABLE	SYSTEM 'A' HEAT/COOL ENABLE		
Q0042	DEFROST SOLENOID	SYSTEM 'A' DEFROST		
Q0043	SYSTEM 1 CASCADE COOLING	SYSTEM 'B' DEFROST		
Q0044	SECONDARY AIR CIRCULATORS	SYSTEM 'B' CIRCULATORS	HIGH SPEED FANS	HOT CHAMBER (DTS LEFT)
Q0045	STACK LIGHT RED	SYSTEM 1B SOLENOIDS	ALTITUDE SYSTEM	IN TRANSFER DOOR LOCK
Q0046	STACK LIGHT YELLOW	SYSTEM 1B COMPRESSOR	MAXIMUM DIVE	BASKET UP
Q0047	STACK LIGHT GREEN	SYSTEM 2B COMPRESSOR	MAXIMUM VACCUUM	BASKET DOWN

### 7.2.1 Output Description of Use

- Audible Alarm (Q0):* This output is used to turn the audible alarm on and off under fault conditions.
- Maximum Cool Enable (Q1):* This output is used to enable and disable the maximum cooling solenoids based on the percentage of output set up in the configurator. When the loop output exceeds the maximum output on percentage for the on delay period set in the configurator, this output will turn on.
- Air Circulator(s) (Q2):* This output is used to turn the chamber air circulator(s) on and off when the chamber event 1 is turned on and off. If defrost is enabled, this output will turn off the air circulator(s) during defrost and will turn back on once defrost is complete.
- System 1 Compressor (Q3):* This output is used to turn system 1 compressor on and off based on the demand for cooling or dehumidification. The output turns on when the loop percentage of output exceeds the on percentage for the delay period set in the configurator. The output will turn off the compressor when the loop percentage of output exceeds the off percentage for the delay period set in the configurator.
- The output also turns on and off with the pressure switch input (I32) if pumpdown is enabled. If main power is off for more than 30 minutes, the input will be ignored, and the output will remain off, until pumpdown is reset automatically after 4 hours or manually by the operator.
- The output is also controlled by the defrost pressure switch (I40). When defrost is enabled, the output will turn system 1 compressor on and off with the input in order to maintain the discharge pressure of system 2 at the proper range during defrost. Note that when large horsepower defrost is enabled, the output will remain on at all times and is not cycled on and off.
- System 2 Compressor (Q4):* This output is used to turn system 2 compressor on and off based on the demand for cooling. It turns on after the stager start delay time set in the configurator. The timer begins once system 1 output turns on. The output turns off when system 1 output turns off.
- During single stage humidity operation, the output is also turned off. The output will remain off until humidity is turned off. The stager start timer will begin again and turn on the output.
- During defrost, the output is forced on to maintain system 2 operation in order to provide hot gas for defrosting of the cooling coils. Once defrost is complete, the output will be controlled by normal cooling requirements.

- Chamber Light(s) (Q5):* This output toggles on and off to turn the chamber light(s) on and off when the light icon on the HMI is pressed.
- Window Heater (Q6):* This output is used to turn the window heater(s) on and off based on the air temperature set point set in the configurator. When the air temperature drops below the set point, the output will turn on after a 1 minute delay. Once the air temperature rises above the set point, the output will then turn off after a 1 minute delay.
- The output will also turn on whenever the humidity system is enabled. This keeps the window clear during high dewpoint conditions in the chamber.
- Product Safety (Q7):* This output acts as a “chamber run” verification for the customer to use as a product under test enable. As long as the chamber is running, i.e., controlling temperature, this output will be on. When the chamber is turned off or in a critical alarm condition, this output is off.
- System 1 Solenoids (Q30):* This output is used to turn on the liquid line and hot gas solenoids on system 1 when the unit is equipped with pumpdown. This allows the solenoids to open and close independently of system 1 compressor operation so that the system can be pumped down.
- During normal cooling operation, this output will turn on with the system 1 compressor output (Q3). When the refrigeration system is no longer required to run, this output will turn off to isolate the high side of the system while the compressor continues to run in order to pump down the system.
- Maximum Heat Enable (Q31):* This output is used to enable and disable the maximum heating SSR based on the percentage of output set up in the configurator. When the loop output exceeds the maximum output on percentage for the on delay period set in the configurator, this output will turn on.
- Humidity System (Q32):* This output is used to turn the humidity system on and off with chamber event 2.
- Maximum Humidify Enable (Q33):* This output is used to enable and disable the maximum boiler SSR based on the percentage of output set up in the configurator. When the loop output exceeds the maximum output on percentage for the on delay period set in the configurator, this output will turn on.
- Dry Air Purge System (Q34):* This output is used to turn the dry air purge system on and off with chamber event 4. It will also turn on automatically when the chamber is equipped with the frozen coil (low RH) option, when needed to reach a low humidity condition.
- Frozen Coil Enable (Q35):* This output is used to enable and disable the operation of the low RH/frozen coil components. In normal humidity mode, this



output will be of so that the wet coil solenoid can be cycled on and off. When operating in frozen coil mode this output will turn on in order to allow the dehumidification output of the 9300 controller to control the frozen coil solenoid instead of the wet coil solenoid.

It also activates the bypass solenoid in order to bypass the EPR valve on the dehumidification coil and switches control of the purge air supply solenoid to the dehumidification output of the 9300 controller.

***LN2 Supply Solenoid (Q36):***

This output is used to turn the LN2 supply solenoid on and off based on chamber event 3. If the boost cool system is set for control mode, it will automatically turn on when required in order for the chamber to obtain temperatures below the capabilities of the refrigeration system.

***LN2 Control Solenoid (Q37):***

This output is used to turn the boost cooling solenoid on and off based on the demand for cooling and settings made in the configurator. It will turn on when the loop output exceeds the “aux cool on percentage” for the on delay time set in the configurator.

***Rate Master Control (Q40):***

This output is used for rate master refrigeration systems. It is used to switch cooling control between the system 1 and system 2 valves. When the output is turned on, system 1 is being used to provide the cooling to the chamber. When the output is off, system 2 is being used to provide cooling the chamber like a typical cascade system.

***Minimum Heat/Cool Enable (Q41):***

This output is used to disable the cooling output from the 9300 controller, typically on chambers with defrost. When defrost is on, this output will be off to prevent any cooling from taking place in order to defrost the cooling coil.

On chambers that using the auxiliary cooling control, this output is used to disable the refrigeration cooling solenoids and switch control over to the auxiliary cooling control solenoids.

***Defrost Solenoid (Q42):***

This output is used to turn on the hot gas defrost solenoid on chambers equipped with defrost. This output will turn on during the defrost period supplying hot gas to the cooling coil.

***Cascade Solenoid Control (Q43):***

The system 1 cascade solenoid control output is used on chambers with rate master refrigeration systems. It is used to disable refrigerant flow to the cascade when running in single stage mode.

This output is also used to control cooling of system 2 when in defrost on large horsepower systems. This output will cycle on and off with the defrost pressure switch input (I40) in order to maintain system 2's head pressure in the proper range. This allows system 1 compressor to run continuously so as not to cycle the compressor on and off.

*RC Blower (Q44):*

This output is active on RC units and is used to turn the RC blower on and off when the chamber is on and event 8 is turned on and off. If defrost is enabled, this output will turn off the blower during defrost and will turn it back on once defrost is complete.

*Stack Light Red (Q45):*

This output can be used to control an optional tower light. The output is on when the chamber is not running.

*Stack Light Yellow (Q46):*

This output can be used to control an optional tower light. The output is on when a critical chamber alarm is active.

*Stack Light Green (Q47):*

This output can be used to control an optional tower light. The output is on when the chamber is running.

**7.2.1.1 Custom Output Configuration (Altitude)**

- Low Speed Fans (Q2):** This output is used to turn on the chamber air circulator(s) in low speed mode. When the altitude exceeds the “Alt Hi Speed Fan Enable SP” in the configurator, this output turns off so the high speed fan output (Q44) can turn on and control the air circulators.
- Min Heat/Cool Enable (Q41):** This output is used to turn the heater contactor on and off since the air circulator outputs turn on and off to vary fan speed under normal operation.
- High Speed Fans (Q44):** This output is used to turn on the chamber air circulator(s) in high speed mode. When the altitude exceeds the “Alt Hi Speed Fan Enable SP” in the configurator, this output turns on. When the altitude drops below the set point, this output turns back off so the low speed fan output (Q2) can turn on and control the air circulators.
- Altitude System (Q45):** This output is used to enable and disable the altitude system and associated components with chamber event 5.
- Max Dive (Q46):** This output is used to enable and disable the 9300 controller output control of the maximum dive solenoid. When the loop output exceeds the maximum output on percentage for the on delay period set in the configurator, this output will turn on.
- Max Vacuum (Q47):** This output is used to enable and disable the 9300 controller output control of the maximum vacuum solenoid. When the loop output exceeds the maximum output on percentage for the on delay period set in the configurator, this output will turn on.

### 7.2.1.2 Custom Output Configuration (DTS, VTS, TSB)

- Hot (left) Chamber (Q40):** This output is used to turn on the left chamber of a DTS or the hot chamber of a VTS using chamber event 1. It is also used to enable both baths for a TSB. When used for a DTS or VTS, the output will turn off during a transfer to stop the fans and then turn back on once the transfer is complete.
- Cold (center) Chamber (Q2):** This output is used to turn on the center chamber of a DTS or the cold chamber of a VTS using chamber event 2. It is not used for a TSB. The output will turn off during a transfer to stop the fans and then turn back on once the transfer is complete.
- Hot (right) Chamber (Q44):** This output is used to turn on the right chamber of a DTS using chamber event 7. The output will turn off during a transfer to stop the fans and then turn back on once the transfer is complete.
- Maximum Heat (right) Enable (Q35):** This output is used to enable and disable the maximum heating SSR for the right chamber of a DTS. When the loop output exceeds the maximum output on percentage for the on delay period set in the configurator, this output will turn on.
- In Transfer Door Lock (Q45):** This output is used to enable a locking mechanism on the chamber door (if equipped) to prevent the door from being opened during a transfer. When the transfer is complete, the output turns off.
- Transfer Left (Q32):** This output is used to turn on the transfer mechanism to move the basket to the left on a DTS or TSB. For a DTS it transfers the left basket into the left (hot) chamber and the right basket into the center (cold) chamber. On a TSB, it transfers the basket from the cold or unload position to the unload or hot position.
- Transfer Right (Q33):** This output is used to turn on the transfer mechanism to move the basket to the right on a DTS or TSB. For a DTS it transfers the right basket into the right (hot) chamber and the left basket into the center (cold) chamber. On a TSB, it transfers the basket from the hot or unload position to the unload or cold position.
- Transfer Up (Q46):** This output is used to turn on the transfer mechanism to move the basket up on a VTS or TSB equipped with a pneumatic transfer mechanism. For a VTS, the basket is transferred into the hot chamber. On pneumatic TSB systems, this lifts the basket out of the baths so that it can move from side to side. It also holds the basket up when the unload position is selected.
- Transfer Down (Q47):** This output is used to turn on the transfer mechanism to move the basket down on a VTS or TSB equipped with a pneumatic transfer mechanism. For a VTS, the basket is moved into the cold chamber. On pneumatic TSB systems, this lowers the basket into the baths once it is positioned over the hot or cold bath.

### 7.2.1.3 Custom Output Configuration (Tandem/Redundant Refrigeration)

**System 'B' Heat/Cool Enable (Q40):** This output is used to disable the cooling output from the 9300 controller when equipped with hot gas defrost. When defrost is on, this output will be off to prevent any cooling from taking place in order to defrost the cooling coil.

**System 'B' Defrost Solenoid (Q43):** This output is used to turn on the hot gas defrost solenoid for system 'B' on chambers equipped with defrost. This output will turn on during the defrost period supplying hot gas to the cooling coil.

**Plenum 'B' Fans (Q44):** This output is used to turn the air circulator(s) for plenum 'B' on and off with event 1 when independent system plenums are used

If defrost is enabled, this output will turn off the air circulator(s) during defrost and will turn back on once defrost is complete.

**System 1B Solenoids (Q45):** This output is used to turn on the liquid line and hot gas solenoids on system 1B when the unit is equipped with pumpdown. This allows the solenoids to open and close independently of system 1B compressor operation so that the system can be pumped down.

During normal cooling operation, this output will turn on with the system 1B compressor output (Q46). When the refrigeration system is no longer required to run, this output will turn off to isolate the high side of the system while the compressor continues to run in order to pump down the system.

**System 1B Compressor (Q46):** This output is used to turn system 1B compressor on and off based on the demand for cooling or dehumidification. The output turns on when the loop percentage of output exceeds the on percentage for the delay period set in the configurator. The output will turn off the compressor when the loop percentage of output exceeds the off percentage for the delay period set in the configurator.

The output also turns on and off with the pressure switch input (I31) if pumpdown is enabled. If main power is off for more than 30 minutes, the input will be ignored, and the output will remain off, until pumpdown is reset automatically after 4 hours or manually by the operator.

*System 2B Compressor (Q47):*

This output is used to turn system 2B compressor on and off based on the demand for cooling. It turns on after the stager start delay time set in the configurator. The timer begins once system 1B output turns on. The output turns off when system 1B output turns off.

During single stage humidity operation, the output is also turned off. The output will remain off until humidity is turned off. The stager start timer will begin again and turn on the output.

During defrost, the output is forced on to maintain system 2B operation in order to provide hot gas for defrosting of the cooling coils. Once defrost is complete, the output will be controlled by normal cooling requirements.

### 7.3 Control Module Status Indicators

All of the digital input and output points on the PLC have indicator lights that tell whether the input or output is on or off. The lights are numbered for quick identification. By using the status lights, it can help diagnose a wiring or component problem in the system. For example, if the output light on the control module is on indicating that the output relay should be on, and the relay is off, it could indicate a bad relay or a problem with the wiring to the relay.

The input and output numbering is octal based. That means that the inputs and outputs increment in groups of 8 and are assigned sequentially as the input and output cards are added. The first group of inputs is I0-I7 (on the CPU) while outputs are Q0-Q7. As additional I/O cards are added, the numbering jumps to I30-I37 and Q30-Q37. The range of Q10-Q27 is skipped.

**!** *The digital input option and customer event output option cards must be installed as the last input and output card (right most position) on the control module CPU. This assures that the proper I/O number assignments are given to the inputs and outputs used for chamber control.*

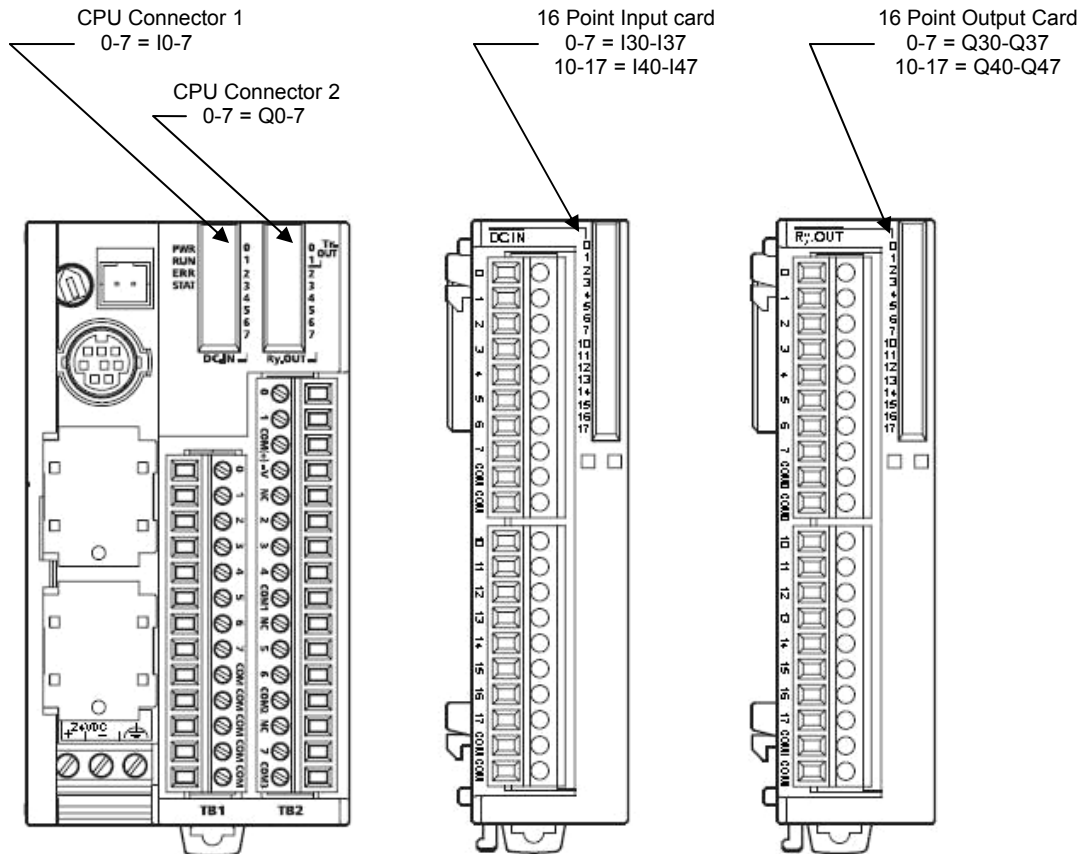

**Figure 7-1 Control Module Input/Output Indicators**

## 8. Adjusting EZT Configuration options

The EZT configurator is used to set the functionality of the EZT to match the chamber type and available options on the chamber. The settings contained in the configurator affect the control of chamber components and systems. Changes to these parameters should only be performed by or under the supervision of CSZ authorized service personnel.



**Changing certain configurator settings to values other than those listed on the EZT Configuration sheet provided with the chamber can cause damage to the chamber and present hazards to personnel. Changes to any configurator settings not specifically called out in this manual may only be done with the consent of an authorized CSZ representative.**

**Failure to comply with this WARNING will void the chamber's warranty.**

### 8.1 Accessing the EZT Configurator

To access the EZT configurator, you must quit the EZT570i application and start the configurator program. To do this, you must have the proper security access to exit the EZT application. All chambers leave the factory with a default user name and password. Select "Logon" under the security menu and enter the default password information:

User:       FACTORY  
Password: CONTROL

Once you are logged in as "Factory", you have the ability to exit the EZT570i application. To exit the application, select "System Maintenance" from the chamber setup menu. Select "Exit Application" from the system maintenance setup menu. Press the "Exit Application" button to quit the EZT-570i application.

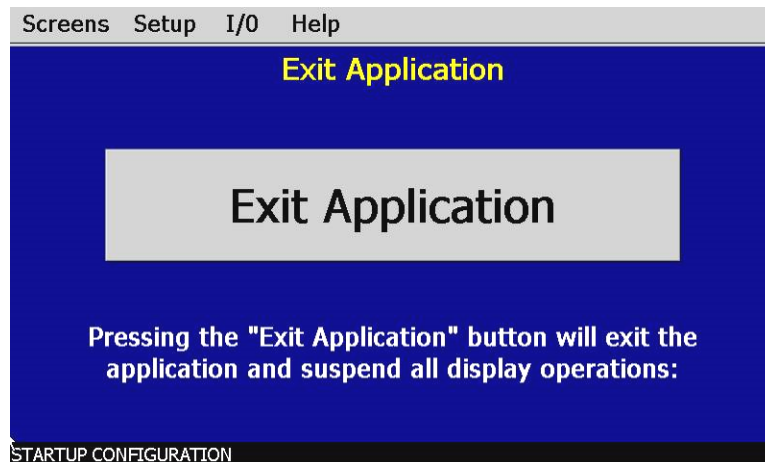

*Figure 8-1 Exit Application*

If security is not enabled, you will not have to log on to gain access to quit the application. However, if security is enabled, and the default password is no longer valid, then you must either obtain the necessary user name and password from the end user of the chamber, or you can bypass the security by turning off power to the chamber.



With the power turned off, remove the SD card from the bottom of the HMI. Turn the power back on and allow the HMI to boot up to the Windows CE desktop (blue screen). Insert the SD card back into the slot in the HMI making sure to insert it in the proper orientation. Touch the thin gray bar at the bottom of the screen to show the Windows task bar and select “Windows Explorer” from the start menu.



**Figure 8-2 Windows Start Menu**

Open the “StorageCard” folder.

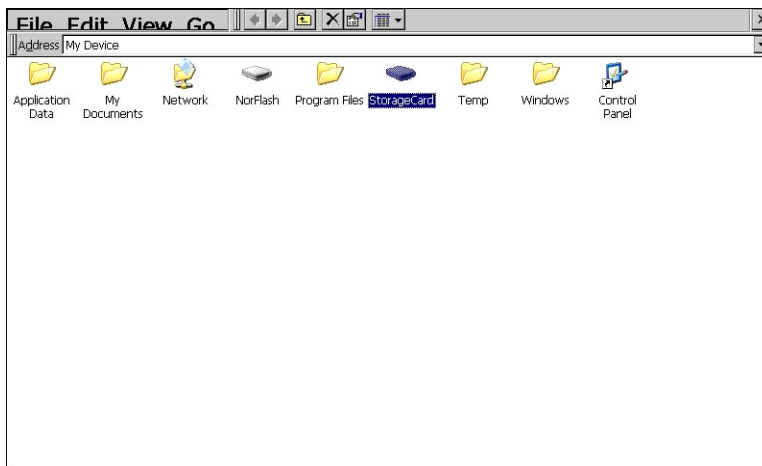

**Figure 8-3 Storage Card**

Open the “EZT570i” folder.

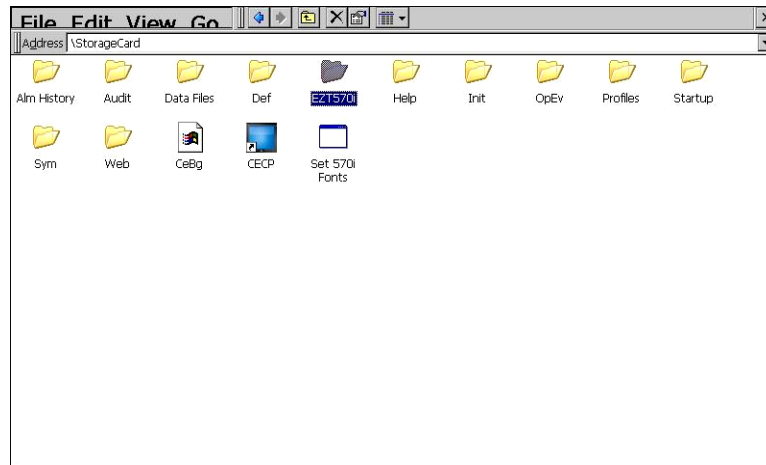

**Figure 8-4 EZT570i Folder**

Select "EZT570i Config" from the EZT570i folder to start the configurator program.

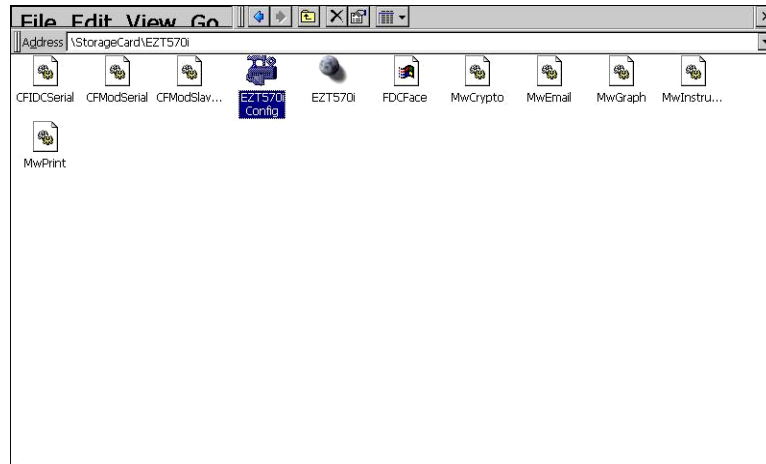

**Figure 8-5 EZT570i Config**

When the configurator application starts, it will default to the "Number of Loops/Monitors" screen.

## 8.2 Number of Loops/Monitors

The number of loops/monitors screen is accessed from the “Loops” menu. It is used to configure the EZT for the number of control loops that are present (9300 controllers), how many monitor inputs are used and how many analog inputs and outputs are installed on the EZT.

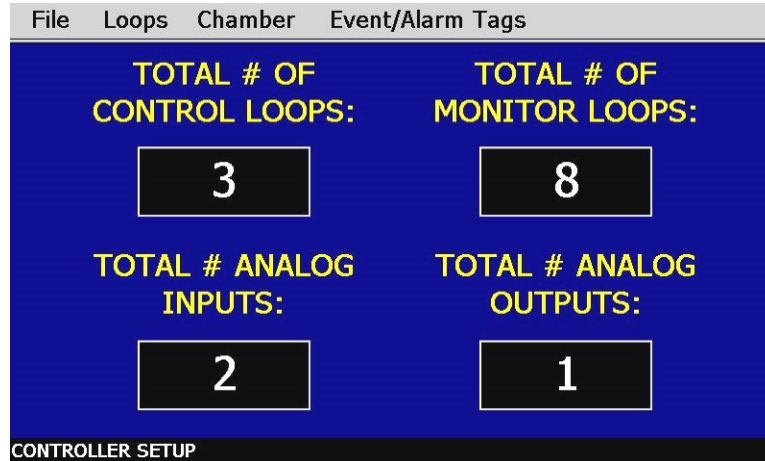

Figure 8-6 Number of Loops/Monitors

Set the number of each item by touching the respective number field. Enter the correct value using the keypad and press done. The EZT can have up to 5 control loops, 8 monitor loops, 5 analog inputs and 4 analog outputs maximum.

### Parameter Descriptions

**Total # of Control Loops:** Sets the number of 9300 control loop displays that are shown on the loop view screens, trend, etc. of the EZT (one for each controlled process, i.e., temperature, humidity, etc.).



*The “Loops/Monitor Tagnames” screen is where the mode of the control loop is selected and enabled/disabled. If a loop is being removed, you must first change the loop to disabled and then change the total number of control loops. Only changing the number of control loops will remove the display from the loop view screens but will not disable the loop. If the 9300 controller is then removed, the chamber will shut down on a “loop comms failure” alarm.*

**Total # of Monitor Loops:** Sets number of monitor inputs connected to the Eagle module. For each enabled input, another loop is added to the loop view screens, trend, etc. for viewing.

**Total # of Analog Inputs:** Sets the number of analog inputs connected to the EZT. When one or more are enabled, the “Analog Input” menu item under the I/O menu in system maintenance will be enabled. This allows the input(s) to be configured from the EZT application.

**Total # of Analog Outputs:** Sets the number of analog outputs connected to the EZT. When one or more are enabled, the “Analog Output” menu item under the I/O menu in system maintenance will be enabled. This allows the input(s) to be configured from the EZT application.

### 8.3 Loops/Monitor Tagnames

The “Loops/Monitor Tagnames” screen is accessed from the “Loops” menu. This screen allows you to define what type of control loop it is, what its name is and specific control output settings for the loop.

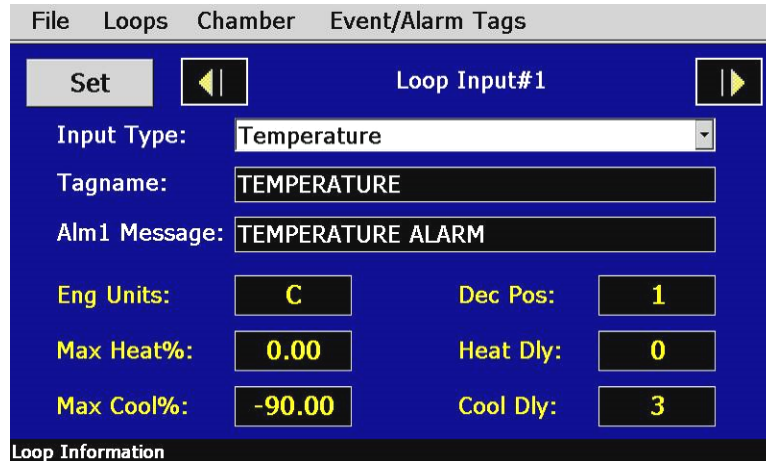



Figure 8-7 Loop/Monitor Tagnames

The arrow keys provided on the upper right of the screen allow you to scroll through all available control loops and monitor loops that have been set on the “Number of Loops/Monitors” screen.

 *You must press the “Set” button to save changes to the input type. Be sure to press the “Set” button prior to switching to another loop or another configuration screen or any change to the input type will not be saved.*

#### Parameter Descriptions

**Input Type:** Sets the type of control loop (temperature, humidity, altitude, etc.).



**Do not alter the loop type to any selection other than what is called out on the EZT Configuration form supplied with the chamber or the chamber may not operate properly and damage to equipment can occur.**

**Tagname:** Sets the name of the loop (what its controlling). This description is used throughout the loop and trend screens as well as input selection screen for data logging in the main EZT-570i runtime application.

**Alm1 Message:** Sets the alarm message that will be used for input alarms. This will be the name displayed on the alarm monitor screen when the user configurable alarm is active.

**Eng Units:** Sets the units for the input (degrees C or F, RH, KFT, etc.). The units are displayed on the single and dual loop display screen.

**Dec Pos:** Sets how many decimal positions to use when displaying an input (always 1).

**Max Heat%:** Sets the loop percentage of output at which the maximum heat output is enabled.

## ***EZT-570i Technical Manual***

---

- Heat Dly:** Sets the delay in seconds for which the loop percentage of output must exceed the max heat% before the max heat output will turn on.
- Max Cool%:** Sets the loop percentage of output at which the maximum cool output is enabled.
- Cool Dly:** Sets the delay in seconds for which the loop percentage of output must exceed the max cool% before the max heat output will turn on.

 *The EZT automatically assigns the digital outputs of additional relays cards for specific options as enabled in the configurator. For a standard dry chamber (non-humidity) that does not have a maximum heat circuit, the “max heat%” and “heat dly” should be set at zero.*

*This insures that when the first relay card is added, the outputs will be used for the customer event option. If the max heat settings are not zero, or another option is installed that uses the outputs on the first 16-output relay card, the second 16-output relay card will be used for customer events if installed.*

### 8.4 Chamber Options

The “Chamber Options” screen is accessed from the “Chamber” menu. This screen is used to define what type of chamber the EZT-570i is being used on and enables special logic for certain types of chambers.

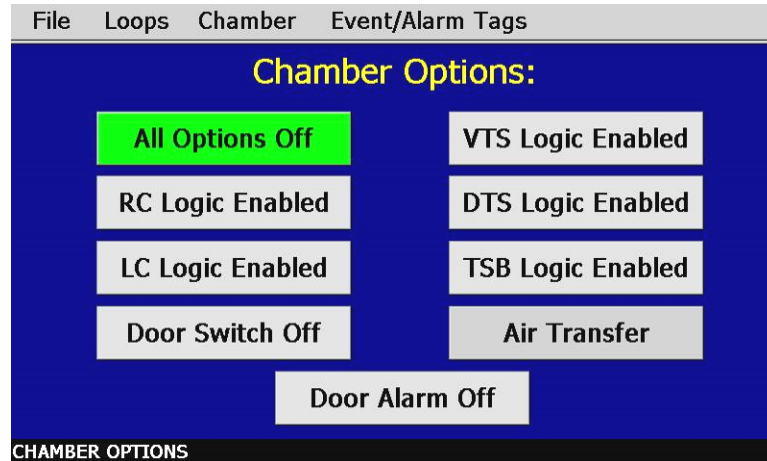

Figure 8-8 Chamber Options

#### Parameter Descriptions

**All Options Off:** Used for all standard temperature/humidity/altitude chambers.

**RC Logic Enabled:** Enables the logic for the RC blower motor. The logic ties event 8 to output Q44 to turn the RC blower motor on and off with the event. Note that this option is typically only used for retrofitting RC chambers that require event control for the blower.

**LC Logic Enabled:** Enables the logic for pump control and fluid system monitoring. The logic turns on output Q44 for the pump with event 1 and enables the input alarm logic for high temperature (I44), pressure (I45) and flow (I46) monitoring.

**VTS Logic Enabled:** Enables the logic for basket position and dual zone control. Loop 1 is set for hot chamber control and loop 2 for cold chamber control. The logic turns on output Q44 for the hot chamber using event 1 while event 2 becomes the cold chamber. Outputs Q46 and Q47 for basket up and down are enabled through events 5 and 6.

Inputs I30 and I31 are used for basket position monitoring for hot and cold chamber positions respectively. The door switch input (I42) is monitored to disable the transfer if either door is opened.

**DTS Logic Enabled:** Enables the logic for basket position and three zone control. Loop 1 is set for the left (hot) chamber control, loop 2 for the center (cold) chamber control and loop 3 is for the right (hot) chamber control. Loops 4 and 5 are set for product control for the left and right basket respectively.

The logic turns on output Q44 for the left chamber using event 1 while event 2 becomes the center chamber. Output Q40 becomes the right chamber control output using event 7 with output Q35 being enabled for the max heat output control. Outputs Q32 and Q33 for basket left and right are enabled through events 5 and 6.

Inputs I6 and I7 are used for basket position monitoring for left and right chamber positions respectively. The door switch input (I42) is monitored to disable the transfer if any door is opened.

**TSB Logic Enabled:** Enables the logic for basket position and dual zone control. Loop 1 is set for the left (hot) bath control and loop 2 for the right (cold) bath control. The door switch input (I42) is monitored to disable the transfer if the lid/door is opened. Inputs I44 and I45 are enabled for the cold bath temperature and hot/cold pump pressure safeties respectively. If the baths are equipped with low level floats, I46 is used as a low level warning input.

Depending on the transfer mechanism used, different inputs and outputs are used to transfer the basket to each position. For motor operated transfer mechanisms, outputs Q32 and Q33 for basket left and right are used to position the basket. For air cylinder operated transfer mechanisms, outputs Q32 and Q33 are used for the left and right movement with outputs Q46 and Q47 used to control the up and down movement.

Events 5 (hot) and 6 (cold) with event 7 for the unload position are used to select the three positions. Inputs I6 and I7 are used to monitor the left (hot) and right (cold) positions. Inputs I30 and I31 are used for up and down position monitoring for air cylinder control. On units with a motor operated mechanism, I31 is used for the unload position indication.

**Air/Motor Transfer:** For DTS/VTS/TSB chambers, this sets the type of transfer mechanism used to move the basket between zones. This setting must match the transfer mechanism type or the transfer mechanism may be damaged.

**Door Switch On/Off:** Sets whether or not the opening and closing of the chamber door (when equipped with a door switch on input (I42) turns the chamber off and on. If enabled, when the door is opened, the chamber will shut down. When the door is closed, the chamber will turn back on.

**Door Alarm On/Off:** Sets whether or not the opening and closing of the chamber door (when equipped with a door switch on input (I42), sounds the audible alarm and displays an alarm message on the alarm monitor screen. This is typically used when the door switch control is also enabled in order to alert the user that the door is open (which is why the chamber isn't running).

The alarm message and audible alarm will only activate when the chamber is running and the door is opened. If the chamber events are off, meaning the chamber is off, the alarm will not sound to eliminate nuisance alarms and allow normal loading/unloading of the chamber when not in operation.

### 8.5 Refrigeration Options

The “Refrigeration Options” screen is accessed from the “Chamber” menu. This screen is used to define what type of refrigeration system the chamber has and how the EZT-570i is to control it.



Figure 8-9 Refrigeration Options

The **Advanced** button provides access to additional refrigeration system settings used with Rate Master, Tandem, Redundant and Tundra II systems.

**!** You must press the “Set” button to save changes to the refrigeration and/or defrost type selections. Be sure to press the “Set” button prior to switching to another configuration screen or any change to the refrigeration and/or defrost type will not be saved.

#### Parameter Descriptions

- Refrig Type:** Sets the type of refrigeration system installed on the chamber (can no refrigeration). Base selections include:
- Single Stage:* selection for standard single stage systems (typically R404a)
  - Tundra:* selection for single stage systems using R410a
  - Cascade:* selection for standard cascade systems
  - Rate Master:* selection for cascade systems with system 1 cooling mode ability
- In addition to the base selections, there are two other selections provides for the single stage, tundra and cascade options. These are the “tandem” and “redundant” modes.
- Tandem:* Selection for dual refrigeration (single stage, Tundra or cascade) in which both systems operate together to provide cooling. Typically used on large chambers or when high heat loads are generated by product under test.
  - Redundant:* Selection for dual refrigeration (single stage, Tundra or cascade) in which only one system operates at a time. If the operating system faults out, the other system will take over. Provided with time share setting son the “Advanced” refrigeration options page, the systems will alternate back and forth to share equal run time.





**Do not change the refrigeration type to any selection other than what is installed on the chamber and called out on the EZT Configuration form supplied with the chamber or the refrigeration system may not operate properly and damage may occur.**

- Cmp On %:** Sets the loop percentage of output required to turn enable the refrigeration system because cooling is required.
- Cmp On Dly:** Sets the delay in seconds for which the loop output must exceed the cmp on % before the refrigeration system is turned on.
- Cmp Off %:** Sets the loop percentage of output required to disable the refrigeration system because cooling is no longer required.
- Cmp Off Dly:** Sets the delay in seconds for which the loop output must exceed the cmp off % before the refrigeration system is turned off.
- Stager Dly:** Sets the stager start delay time in seconds for system 2 on cascade systems.
- Defrost:** Sets the defrost mode based on installed defrost components.  
- “Defrost On” is used for smaller compressors (typically smaller than 7.5hp)  
- “Large HP Defrost” is used for larger systems (typically larger than 7.5hp)

The large horsepower defrost is used to control the cascade condenser liquid line cooling solenoids on cascade systems. It cycles the solenoids on and off to maintain system 2 head pressures rather than cycling the system 1 compressor on and off. Cycling large horsepower compressors is detrimental to the life of the compressor and is not recommended by the manufacturer.

The “**alternating**” defrost selections are only used for redundant refrigeration systems that use independent conditioning plenums. This allows one system to go into defrost while the other system conditions the chamber. The “Ind Plenum” (independent plenums) selection under the advanced settings must be selected prior to selecting an alternating defrost mode or the selection will not be accepted.

- Pumpdown On/Off:** Enables or disables pumpdown mode.
- PumpDown Reset Time Out:** Sets the time in seconds for which the chamber can be without power before pumpdown will be disabled and require manual reset or the four hour automatic reset delay.

### 8.5.1 Refrigeration Advanced Options

The “Refrigeration Advanced Options” screen is accessed from the “Advanced” button on the Refrigeration Options screen. This screen is used to enter refrigeration system specific setpoints and operating mode selections for the Rate master, Tandem, Redundant and Tundra II type refrigeration systems. To exit the screen, press the “Done” button once all settings have been made.

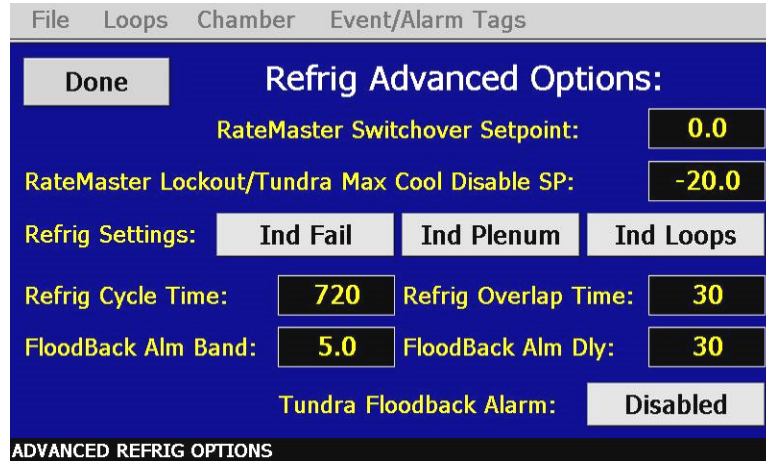

Figure 8-10 Refrigeration Advanced Options

#### Parameter Descriptions

##### **RateMaster Switchover Setpoint**

Defines the setpoint for chamber air temperature below which the rate master refrigeration system will switch from single stage operation to cascade operation. Note that the actual air temperature setpoint on the EZT-570i must be at or below the “RateMaster Lockout” setpoint for the switchover to occur.

##### **RateMaster Lockout/Tundra Max Cool Disable SP:**

For rate master systems, this setpoint defines the chamber air temperature below which the refrigeration system will only operate in cascade mode. For Tundra systems, this setpoint defines the chamber air temperature below which the maximum cool output of the EZT is disabled.

##### **Refrig Settings**

These buttons enable/disable functions associated with tandem and redundant refrigeration system type selections.

*Ind Fail:* (independent system failure) When selected allows the chamber to continue operation upon failure of one of the refrigeration systems. If not selected, a failure of one system shuts down the chamber until the alarm condition is cleared.

*Ind Plenum:* (independent system plenums) When selected enables logic within the EZT-570i to operate two refrigeration system plenums (one for each refrigeration system). This must be selected in order to enable alternating defrost.

*Ind Loops:* (independent control loops) When selected enables logic within the EZT-570i to use 9300 controllers hidden as loops 4 and 5 for independent temperature and humidity control of the second plenum (independent system plenums must also be selected).

*The EZT-570i runtime application will show only one temperature and humidity control loop, but will transmit the same setpoints to both plenum controls. If*

*redundant operation is specified, the EZT-570i will display the readings from the operating plenum. If tandem operation is specified, the EZT-570i will display the average reading from both plenum control loops.*

**Refrig Cycle Time**

The refrigeration cycle time sets the interval period used for redundant refrigeration in which the EZT-570i will alternate between systems to equalize run time.

**Refrig Overlap Time**

The refrigeration overlap period sets the time period for redundant refrigeration in which the systems will overlap to allow the system that is just starting enough time to get to operating temperature. Typically required for cascade systems to allow the stager start delay period to expire prior to turning off the currently operating system.

**Floodback Alm Band**

The floodback alarm band is used for Tundra II systems to set the minimum superheat allowed at the suction of the compressor to prevent liquid floodback from damaging the compressor. The “Tundra Floodback Alarm” must be enabled for this setting to be used. When enabled, and the superheat falls below this setting, the maximum cool output is disabled and the alarm delay is activated.

**Floodback Alm Dly**

The floodback alarm delay is used for Tundra II systems to set the alarm delay period when a floodback condition is detected based on the superheat falling below the floodback alarm band setting. The “Tundra Floodback Alarm” must be enabled for this setting to be used.

**Tundra Floodback Alarm Enable/Disable**

The Tundra floodback alarm is used for Tundra II systems to detect a floodback condition at the compressor which could lead to compressor damage due to liquid slugging. When enabled, logic in the EZT-570i will be activated and use a 9300 controller to monitor the suction temperature and pressure at the compressor and shut down the system if a floodback condition is detected.

### 8.6 Humidity Options

The “Humidity Options” screen is accessed from the “Chamber” menu. This screen is used to define what type of humidity system the chamber has and how the EZT-570i is to control it.

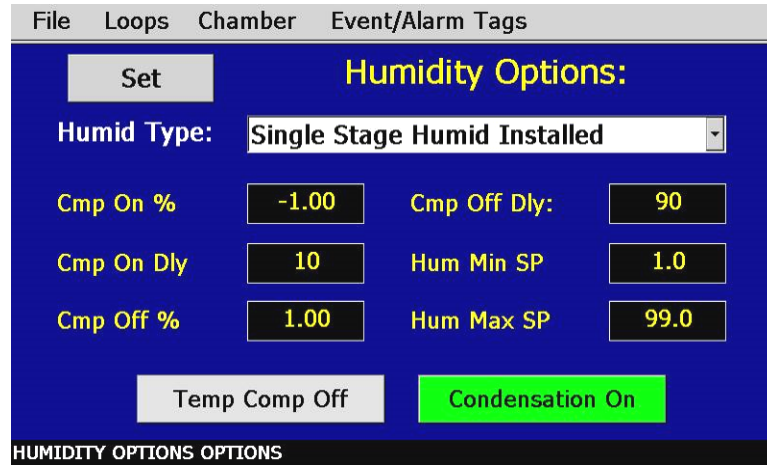

Figure 8-11 Humidity Options

**!** You must press the “Set” button to save changes to the humidity system type selection. Be sure to press the “Set” button prior to switching to another configuration screen or any change to the humidity system type will not be saved.

#### Parameter Descriptions

- Humid Type:** Sets the type of humidity system installed on the chamber.
  - “Humidity Installed” is for single stage/tundra systems or cascade systems without a separate RH cooling circuit on system 1.
  - “Single stage humid installed” is for cascade systems that run in single stage mode during humidity (have separate RH cooling circuit on system 1).
- Cmp On %:** Sets the loop percentage of output required to enable the refrigeration system in order to provide dehumidification.
- Cmp On Dly:** Sets the delay in seconds for which the loop percentage of output must exceed the cmp on % before the refrigeration system is turned on.
- Cmp Off %:** Sets the loop percentage of output required to disable the refrigeration system because dehumidification is no longer required.
- Cmp Off Dly:** Sets the delay in seconds for which the loop percentage of output must exceed the cmp off % before the refrigeration system is turned off
- Hum Min SP:** Sets the minimum air temperature set point at which the humidity system will operate. When the air temperature set point and/or air temperature is below this value, the humidity system will be automatically turned off and the system status indicator “RH TMP DISABLE” will be lit.

**Hum Max SP:** Sets the maximum air temperature set point at which the humidity system will operate. When the air temperature set point and/or air temperature is above this value, the humidity system will be automatically turned off and the system status indicator “RH TMP DISABLE” will be lit.

**Temp Comp On/Off:** Enables or disables the humidity sensor temperature compensation algorithm in the EZT depending on whether or not a compensated sensor is used.



*The compensation is for a Vaisala HMM30C sensor only. Do not use it for other brands of sensors. This should be disabled when using compensated humidity sensors. If set incorrectly, the EZT will not read the correct humidity in the chamber.*

**Condensation On/Off:** Enables or disables the condensation control option. This feature can reduce the formation of condensation during testing on product within the chamber. However, it can greatly reduce the performance of the chamber. This option is used for special circumstances only.

### 8.7 Purge/Lo RH Options

The “Purge/Lo RH Options” screen is accessed from the “Chamber” menu. This screen is used to define what type of purge system is installed on the chamber and what dewpoint limits the humidity system is allowed to control to, if equipped.

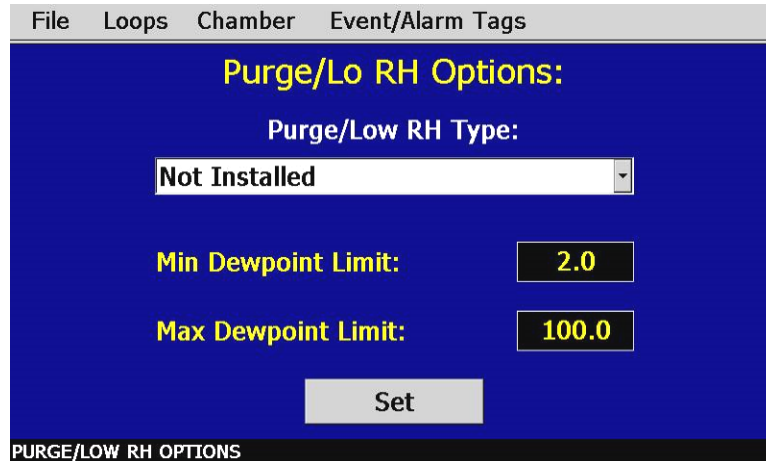



Figure 8-12 Purge/Lo RH Options

 You must press the “Set” button to save changes to the purge system type selection. Be sure to press the “Set” button prior to switching to another configuration screen or any change to the purge system type will not be saved.

#### Parameter Descriptions

**Purge/Low RH Type:** Sets the type of purge system installed.  
 - “Dry Air Purge” is used when just the air dryer is installed.  
 - “Low RH Option Installed” is used when the frozen coil option is installed.

**Min Dewpoint Limit:** Sets the minimum dewpoint that the chamber will control to. In essence, this limits the minimum humidity level that the chamber can achieve at a given temperature.

This value is used to protect the refrigeration system from liquid refrigerant flood back that can happen when trying to achieve to low of a humidity level at lower air temperatures.

Standard humidity is limited to a 2C (35F) dewpoint.  
 The low RH option is limited to a -30.0C (-22F) dewpoint.

**Max Dewpoint Limit:** Sets the maximum dewpoint that the chamber will control to. In essence, this limits the maximum humidity that the chamber can achieve at a given temperature.

This value is primarily used to protect modular walk-ins. The modular walk-in panels can not withstand high temperature and humidity levels.

Standard chambers typically have a setting of 100C (212F).  
 Modular walk-ins are typically limited to 70C (158F).

## 8.8 Auxiliary Cooling Options

The “Aux Cooling Options” screen is accessed from the “Chamber” menu. This screen is used to define what type of boost cooling the chamber has, if equipped.

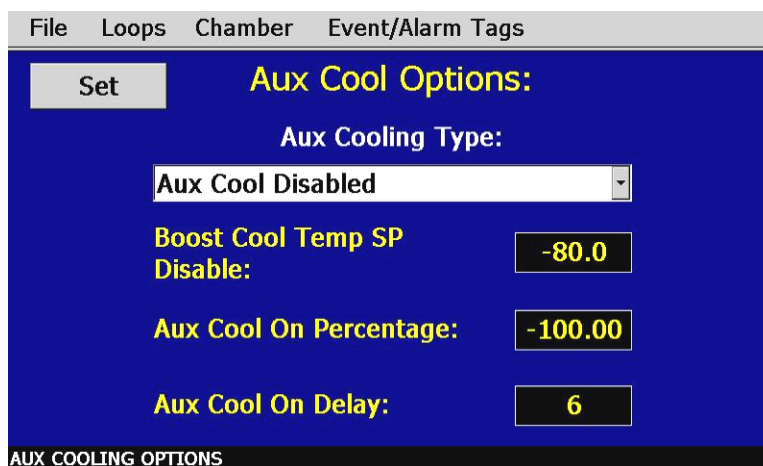



Figure 8-13 Aux Cooling Options

 You must press the “Set” button to save changes to the auxiliary cooling type selection. Be sure to press the “Set” button prior to switching to another configuration screen or any change to the auxiliary cooling type will not be saved.

### Parameter Descriptions

**Aux Cooling Type:** Sets the type of boost cooling system installed on the chamber.  
 - “Aux cool boost” is for the standard boost option that is used to assist the refrigeration system.  
 - “Aux cool control” is for chambers that have extended low temperature operation which go colder than the range of the refrigeration system.

**Boost Cool Temp SP Disable:** Sets the temperature below which the refrigeration system is automatically disabled if “aux cool control” is selected. The boost cooling system will then switch to control mode and start controlling temperature below this set point.

If “aux cool boost” is selected, the boost outputs will be disabled below this set point to prevent the chamber from exceeding the limits of the refrigeration system.



**For boost only mode, this set point must be set no lower than the minimum achievable temperature of the refrigeration system or the compressors can be damaged.**

**Aux Cool On Percentage:** Sets the loop percentage of output required to enable the boost cooling output.

**Aux Cool On Delay:** Sets the delay in seconds for which the loop percentage of output must exceed the aux cool on percentage before the refrigeration boost cool output is turned on.

### 8.9 Configuration Options

The “Configuration Options” screen is accessed from the “Chamber” menu. This screen is used to set general values relating to altitude system operation and other options.

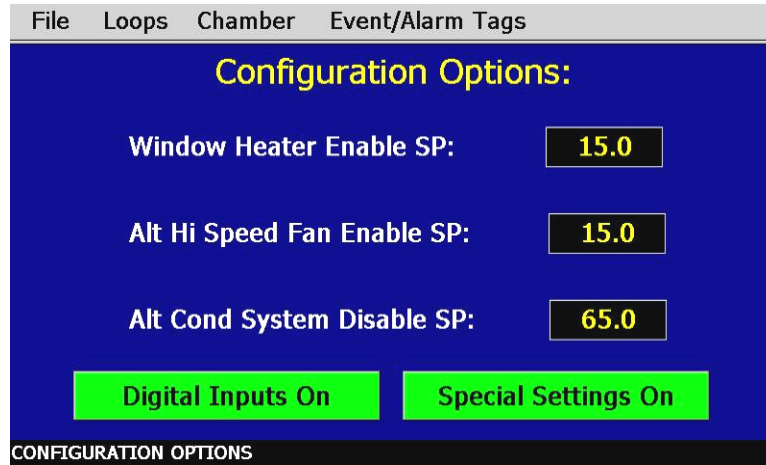

Figure 8-14 Altitude Options

Set the value of each item by touching the respective number field. Enter the correct value using the keypad and press done. Enable the digital inputs or special settings by pressing the respective enable buttons.

#### Parameter Descriptions

- Window Heater Enable SP:** Sets the temperature below which the window heater turns on.
- Alt Hi Speed Fan Enable SP:** Sets the altitude (in Kft) above which the high speed fans will be turned on.
- Alt Cond System Disable:** Sets the altitude above which the conditioning system will be automatically disabled.
- Digital Inputs Off/On:** Enables/disables the digital input option on the EZT. The digital input card must be installed on the EZT for the option to work.
- Special Settings Off/On:** Enables/disables the special settings screen in the EZT application for custom settings use. If used on a chamber, it will be application specific.



### 8.10 CSZ Events

The “CSZ Events” screen is accessed from the “Event/Alarm Tags” menu. This screen is used to set the names for the events of chamber options present.

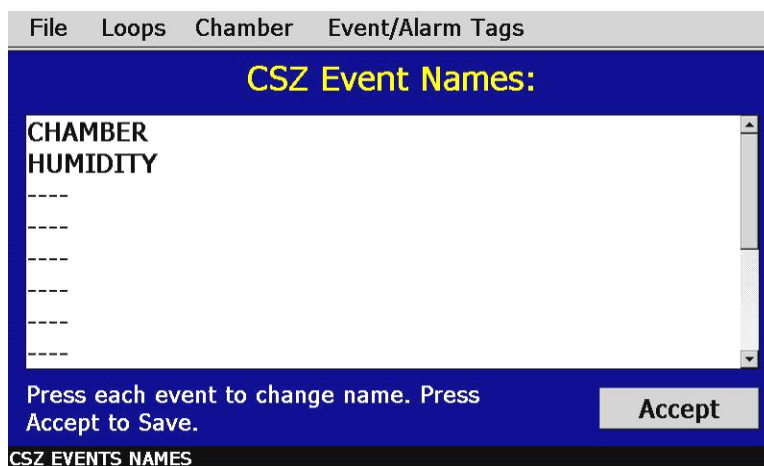

*Figure 8-15 CSZ Event Names*

To change or edit a tag name, touch the position for the event and change the name using the pop-up keypad. Note that event names are limited to 20 characters in length.

- 
**Altering the event names from those listed on the EZT Configuration sheet provided with the chamber may make their use unclear and cause operator confusion. Use discretion when altering tag names.**

### 8.11 Critical Chamber Alarms

The “Critical Chamber Alarms” screen is accessed from the “Event/Alarm Tags” menu. This screen is used to set the names for the different system alarms in the chamber.



*Figure 8-16 Critical Chamber Alarm Names*

To change or edit a tag name, touch the position for the alarm and change the name using the pop-up keypad. Note that alarm names are limited to 20 characters in length.

- 

*Altering the alarm names from those listed on the EZT Configuration sheet provided with the chamber may cause operator confusion when diagnosing alarms. Use discretion when altering tag names.*

### 8.12 Critical Refrigeration Alarms

Access the “Critical Refrigeration Alarms” screen from the “Event/Alarm Tags” menu. This screen is used to set the names for the different refrigeration system alarms.

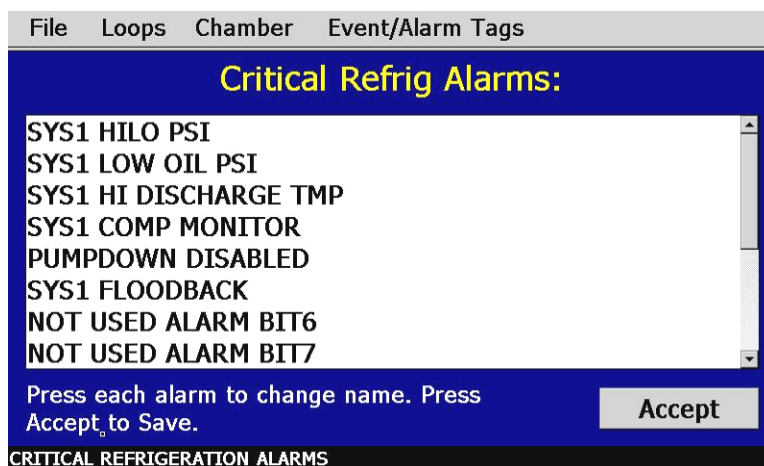

*Figure 8-17 Critical Refrigeration Alarm Names*

To change or edit a tag name, touch the position for the alarm and change the name using the pop-up keypad. Note that alarm names are limited to 20 characters in length.

- 
**Altering the alarm names from those listed on the EZT Configuration sheet provided with the chamber may cause operator confusion when diagnosing alarms. Use discretion when altering tag names.**

### 8.13 Non-Critical Alarms

Access the “Non-Critical Alarms” screen from the “Event/Alarm Tags” menu. This screen is used to set the names for the different system status alarms such as service monitors.

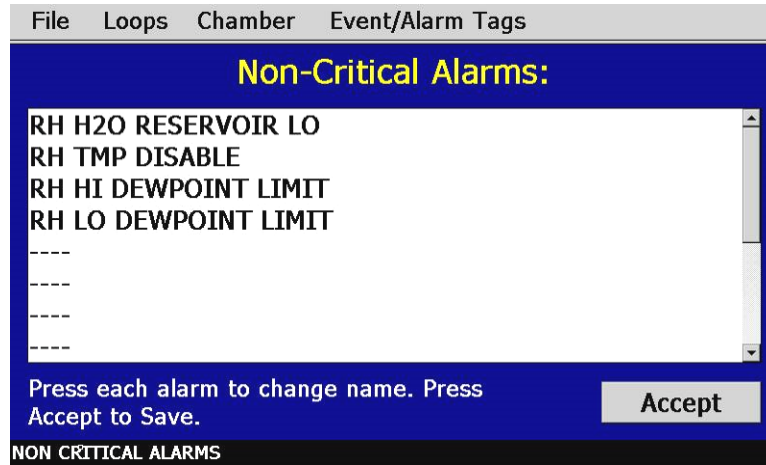

*Figure 8-18 Non-Critical Alarm Names*

To change or edit a tag name, touch the position for the alarm and change the name using the pop-up keypad. Note that alarm names are limited to 20 characters in length.

- 

 Altering the alarm names from those listed on the EZT Configuration sheet provided with the chamber may cause operator confusion when diagnosing alarms. Use discretion when altering tag names.

### 8.14 Maintenance Alarms

Access the “Maintenance Alarms” screen from the “Event/Alarm Tags” menu. This screen is used to set the names for the different service monitors of each system component.

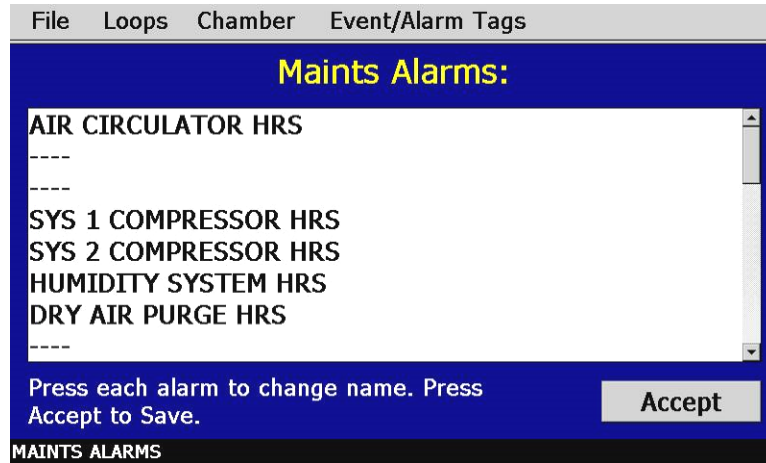

*Figure 8-19 Maintenance Alarm Names*

To change or edit a tag name, touch the position for the alarm and change the name using the pop-up keypad. Note that alarm names are limited to 20 characters in length.

- 
**Altering the alarm names from those listed on the EZT Configuration sheet provided with the chamber may cause operator confusion when diagnosing alarms. Use discretion when altering tag names.**

### 8.15 Special Settings Tagnames

Access the “Special Settings” screen from the “Event/Alarm Tags” menu. This screen is used to set the names for the different “special settings” values in the EZT application.

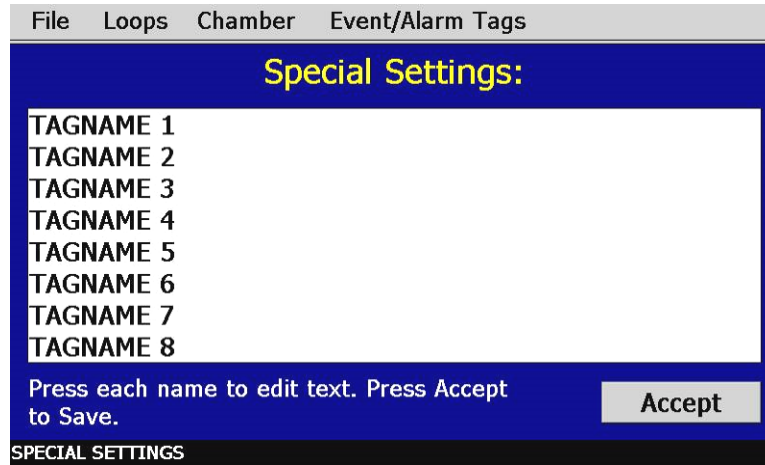

*Figure 8-20 Special Settings Names*

To change or edit a tag name, touch the position for the alarm and change the name using the pop-up keypad. Note that alarm names are limited to 10 characters in length.

- 
Altering the tag names from those listed on the EZT Configuration sheet provided with the chamber may cause operator confusion when viewing the special setting fields. Use discretion when altering tag names.

**8.16 Completing EZT570i Configuration**

Any changes made in the configurator program must be backed up prior to cycling power to the EZT. First, exit the configurator by selecting “Exit” from the “File” menu. **DO NOT** cycle power to the controller yet. First, manually back up the settings to EEPROM. To do this, you must rotate the small pot on the control module CPU.

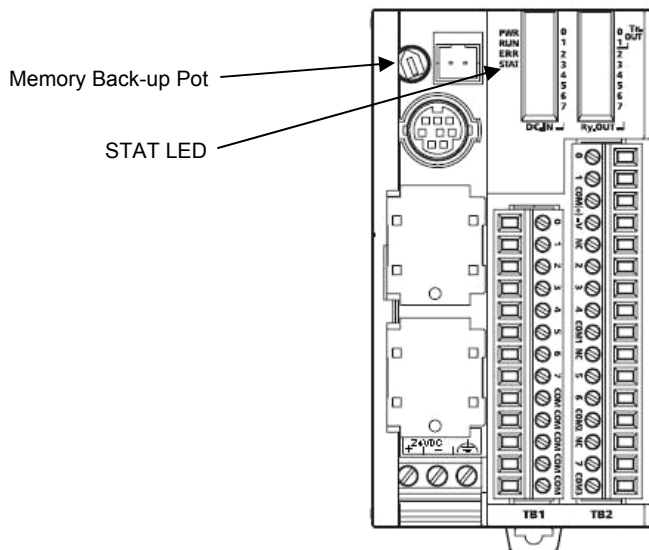

**Figure 8-21 EEPROM Configuration Back-up**

Gently turn the pot full counterclockwise, then fully clockwise and back counterclockwise again. The small “STAT” LED on the CPU will blink indicating that the configuration has been saved. You can now cycle power to the EZT and allow it to boot up normally.

- ❗ If the settings are not backed up to EEPROM prior to cycling power, all changes will be lost and the values will revert back to their original settings.





## Appendix

**List of Figures**

Figure 4-1 Defrost Settings..... 10

Figure 5-1 Web Server/Modbus/VNC Communication Settings ..... 31

Figure 5-2 Serial Port Mode Settings ..... 32

Figure 6-1 Windows Start Menu ..... 39

Figure 6-2 NORFlash Directory ..... 39

Figure 6-3 Write Error on Boot ..... 40

Figure 6-4 Windows Start Menu ..... 40

Figure 6-5 CECF ..... 41

Figure 6-6 Serial Port Settings ..... 41

Figure 6-7 Touch Calibration Screen ..... 42

Figure 6-8 Setup Menu Access ..... 43

Figure 6-9 Chamber Setup Menu Access ..... 43

Figure 6-10 System Maintenance Setup menu Access ..... 44

Figure 6-11 Calibrate Touch ..... 44

Figure 6-12 CECF Touch Screen Settings..... 44

Figure 6-13 Touch Calibration Screen ..... 45

Figure 7-1 Control Module Input/Output Indicators ..... 67

Figure 8-1 Exit Application..... 68

Figure 8-2 Windows Start Menu ..... 69

Figure 8-3 Storage Card..... 69

Figure 8-4 EZT570i Folder ..... 70

Figure 8-5 EZT570i Config ..... 70

Figure 8-6 Number of Loops/Monitors..... 71

Figure 8-7 Loop/Monitor Tagnames ..... 72

Figure 8-8 Chamber Options ..... 74

Figure 8-9 Refrigeration Options ..... 76

Figure 8-10 Refrigeration Advanced Options ..... 78

Figure 8-11 Humidity Options ..... 80

Figure 8-12 Purge/Lo RH Options ..... 82

Figure 8-13 Aux Cooling Options ..... 83

Figure 8-14 Altitude Options ..... 84

Figure 8-15 CSZ Event Names ..... 85

Figure 8-16 Critical Chamber Alarm Names ..... 86

Figure 8-17 Critical Refrigeration Alarm Names..... 87

Figure 8-18 Non-Critical Alarm Names ..... 88

Figure 8-19 Maintenance Alarm Names..... 89

Figure 8-20 Special Settings Names ..... 90

Figure 8-21 EEPROM Configuration Back-up..... 91

## **List of Tables**

Table 5-1 Common Serial Communication Problems and Corrective Actions.....	32
Table 5-2 Common EZ-View Start-up Problems and Corrective Actions.....	33
Table 5-3 Common GPIB Communication Problems and Corrective Actions .....	34
Table 5-4 Common Ethernet Communication Problems and Corrective Actions .....	35
Table 7-1 Chamber Events.....	46
Table 7-2 Control Loops .....	46