



# EZT-550 Controller Instruction Manual



## TABLE OF CONTENTS

|           |                                            |           |
|-----------|--------------------------------------------|-----------|
| <b>1.</b> | <b>Overview .....</b>                      | <b>4</b>  |
|           | 1.1 Menu Bar Function Tree .....           | 4         |
|           | 1.2 Touch Screen Interface .....           | 6         |
| <b>2.</b> | <b>Monitoring .....</b>                    | <b>7</b>  |
|           | 2.1 Chamber Monitor .....                  | 7         |
|           | 2.2 Chamber Detail .....                   | 8         |
|           | 2.3 Trend Graph .....                      | 9         |
|           | 2.4 Graphic Monitor .....                  | 10        |
|           | 2.5 System Alarms.....                     | 10        |
|           | 2.6 Profile Status View.....               | 11        |
| <b>3.</b> | <b>Single Setpoint Operation.....</b>      | <b>13</b> |
|           | 3.1 Single Setpoint Adjustment .....       | 13        |
|           | 3.2 Event Control (Chamber On/Off) .....   | 14        |
|           | 3.2.1 Chamber Options.....                 | 15        |
| <b>4.</b> | <b>Profile Operation.....</b>              | <b>17</b> |
|           | 4.1 Profile Create/Edit.....               | 17        |
|           | 4.2 Guaranteed Soak Limits .....           | 21        |
|           | 4.3 Plot Profile .....                     | 22        |
|           | 4.4 Start/Stop Profile.....                | 23        |
|           | 4.4.1 Hold/Resume a Profile.....           | 24        |
|           | 4.4.2 Advance Previous/Next Step.....      | 24        |
| <b>5.</b> | <b>Chamber Setup .....</b>                 | <b>25</b> |
|           | 5.1 Control Tuning .....                   | 25        |
|           | 5.1.1 How to Adjust Tuning Parameters..... | 27        |
|           | 5.2 Device Under Test (DUT) .....          | 28        |
|           | 5.3 Event Tag Names .....                  | 29        |
|           | 5.4 Power Recovery .....                   | 30        |
|           | 5.5 Timer Setup .....                      | 31        |
|           | 5.6 Defrost Settings .....                 | 33        |
| <b>6.</b> | <b>Datalogging .....</b>                   | <b>34</b> |
|           | 6.1 Start/Stop Datalogging.....            | 34        |
|           | 6.2 View Log File .....                    | 35        |
|           | 6.2.1 Deleting Log Files.....              | 38        |
| <b>7.</b> | <b>System Maintenance .....</b>            | <b>39</b> |
|           | 7.1 Set Date/Time .....                    | 40        |
|           | 7.2 Level 1 (User) Security Options.....   | 41        |
|           | 7.2.1 Degrees C/F Selection .....          | 41        |
|           | 7.2.2 Maintenance Counters .....           | 42        |
|           | 7.2.3 Calibration.....                     | 43        |
|           | 7.3 Factory Security Options .....         | 50        |
|           | 7.3.1 Setpoint Limits .....                | 50        |
|           | 7.3.2 Startup Configuration.....           | 50        |
| <b>8.</b> | <b>File Access .....</b>                   | <b>51</b> |
|           | 8.1 Opening Files.....                     | 51        |

|                                               |           |
|-----------------------------------------------|-----------|
| <b>9. Communications</b> .....                | <b>53</b> |
| 9.1 Connecting a Computer to the EZT-550..... | 53        |
| 9.1.1 RS-232 Serial Connection .....          | 53        |
| 9.2 Maintenance Protocol.....                 | 54        |
| 9.2.1 Write Data Command .....                | 55        |
| 9.2.2 Read Data Command.....                  | 57        |
| 9.2.3 BCC Block Check Calculation .....       | 58        |
| 9.3 EZT-550 Operands.....                     | 59        |
| 9.3.1 Profile Area Operands .....             | 63        |

## Introduction

This manual has been tailored to match the specific features and options provided on the ZP(H) Series chambers. Do not use this manual in an attempt to operate or maintain any other model chamber. It is highly recommended that the end user read this manual thoroughly and understand all aspects of the chamber's operation prior to operating the chamber.

**WARNING** Warnings identify any condition or practice that, if not strictly observed, could result in serious personal injury or possible loss of life.

**CAUTION** Cautions identify any condition or practice that, if not strictly observed, could result in damage to, or destruction of, the system equipment.

### Device Under Test (DUT) Protection

The chamber is equipped with high heat limits and/or safety devices. These devices are installed to protect the chamber from exceeding design limits. These devices remove power from the chamber's heaters ONLY and DO NOT remove power from the device under test.

Provisions must be made by the end user to de-energize the tested device in the event of an over-temperature condition. For this reason, the chamber is equipped with a DUT safety relay that should be connected to the device's power supply control circuit. In the event of an over-temperature condition, the relay will open and de-energize the device under test to prevent a runaway thermal condition. See section 5.2 for more information on the use of this safety feature.

### Screen Displays

The graphic displays shown in this manual are based on ZPH Series chamber with the humidity option. Screens displayed on temperature only chambers (ZP Series) will differ slightly from those shown. The temperature only models will not include values or settings for humidity.

# 1. Overview

The EZT-550 Controller is not just another graphic interface for operating and monitoring the chamber. It is an intelligent device that monitors and protects the chamber from adverse operating conditions. It does this without the need for user intervention or knowledge on system operation. The displays provide the user with an intuitive interface for navigating through the different menus and settings without having to go multiple levels deep in screens like other “button style” systems. The EZT-550 provides a “Windows” like feel with drop down menus and online help at all times. This section of the manual provides an overview of the menu items and structure.

## 1.1 Menu Bar Function Tree

The menu structure for the EZT-550 is as shown below:

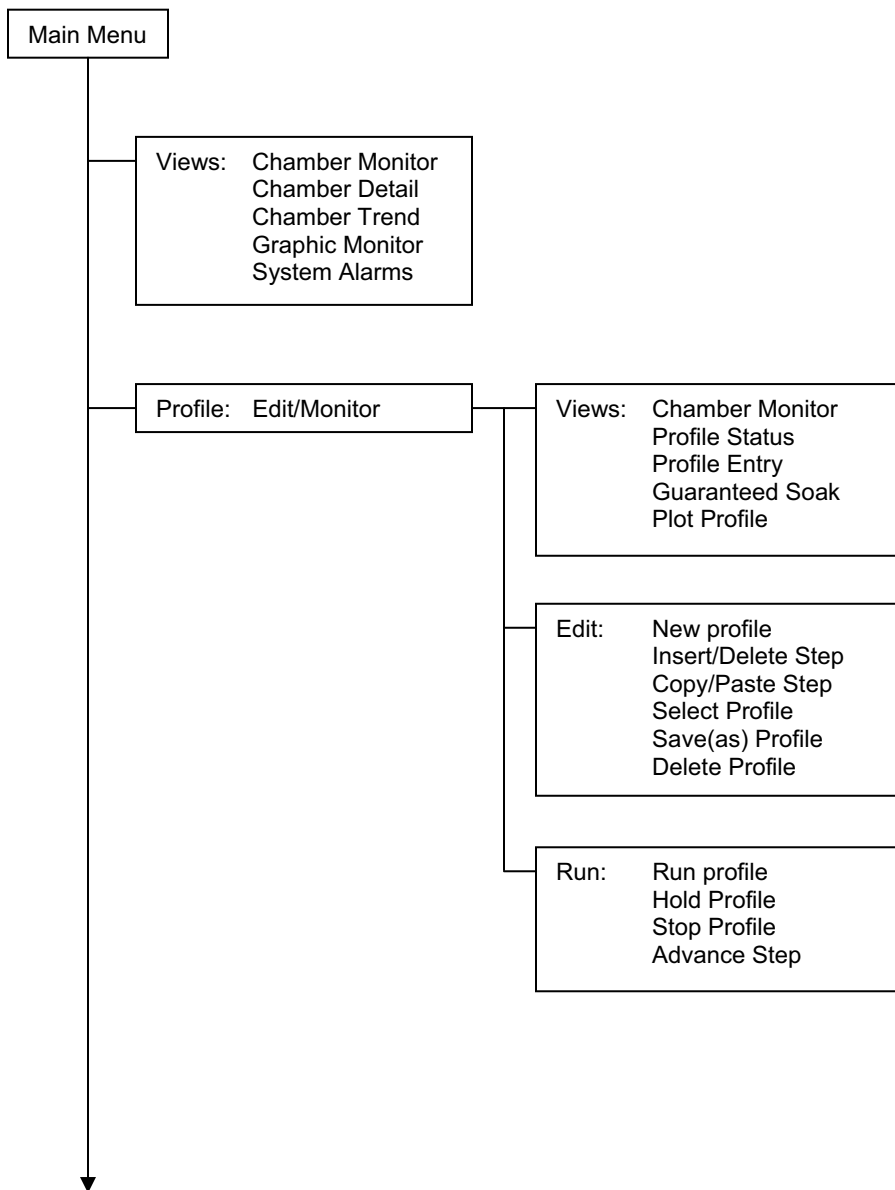

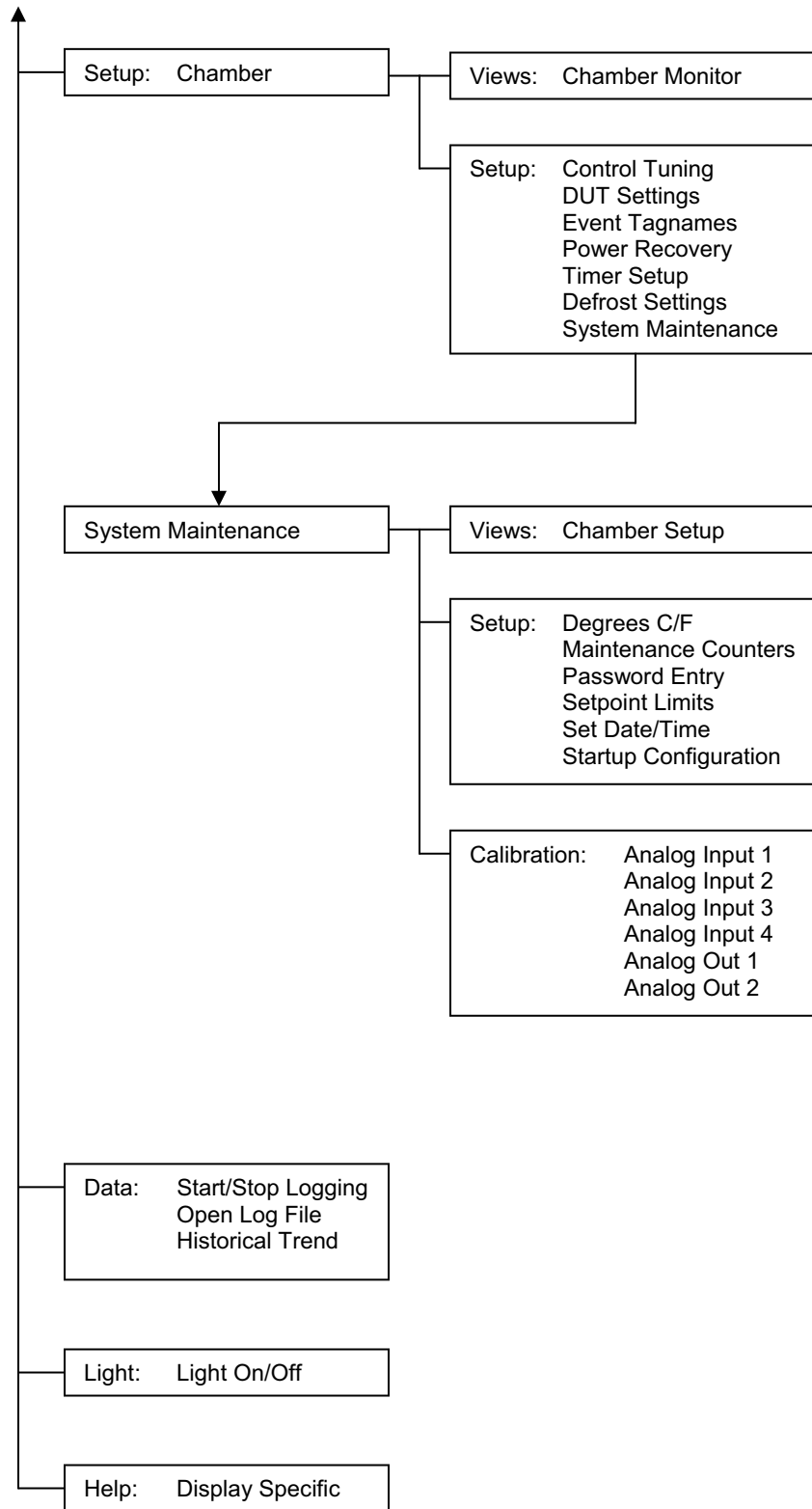

## 1.2 Touch Screen Interface

The EZT-550 display is divided into three main sections; the menu bar, main display area and detail window.

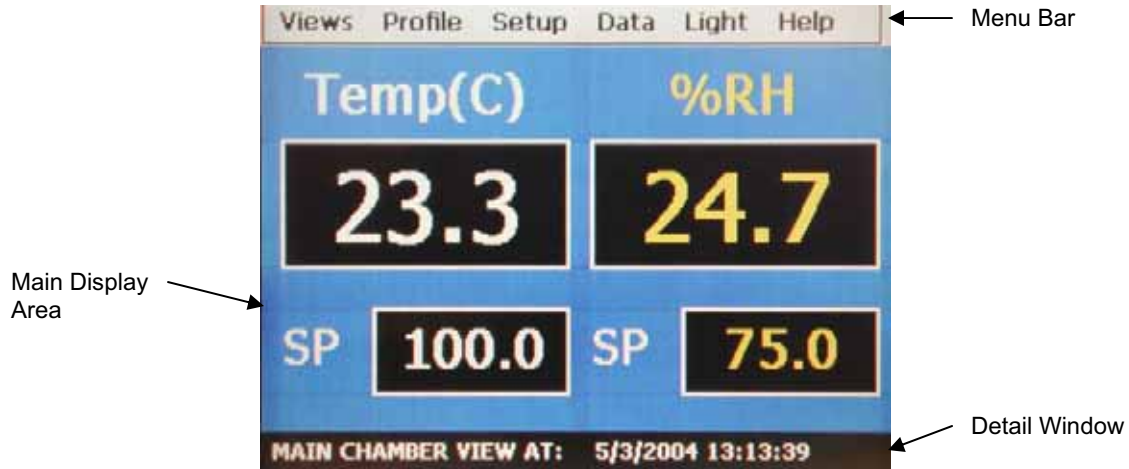

- Menu Bar:** The menu bar is used to navigate through the various monitoring and control screens.
- Main Display Area:** The main display area contains the active items for the menu item selected.
- Detail Window:** The detail window provides display specific information.

To select items on the display, simply touch the desired text or numerical entry item. Do not use any sharp or metal objects on the touch screen as they will damage the interface. For detailed information regarding the different screen elements, see the following sections.

## 2. Monitoring

The chamber monitoring screens provide various means of verifying chamber operation and performance. The displays are accessed from the main menu under “Views”.



### 2.1 Chamber Monitor

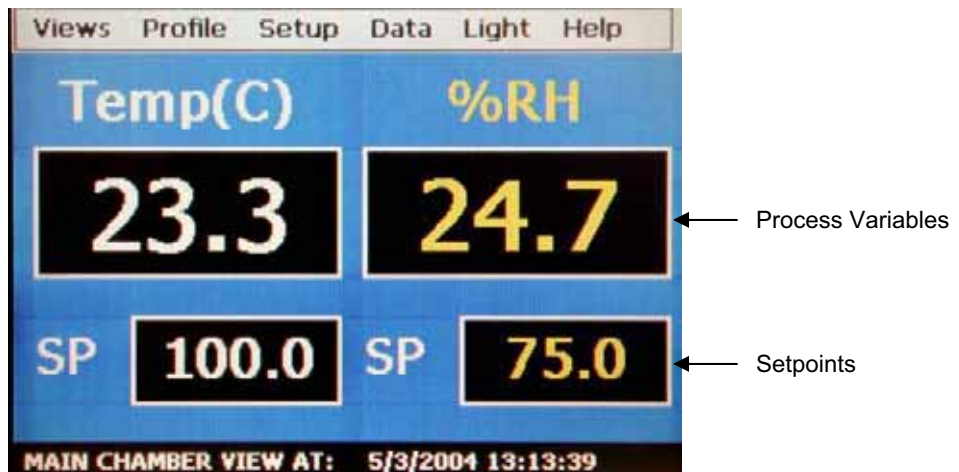

The monitor screen displays the current setpoints and process variables. The setpoints can be modified from this screen by touching the setpoint field box. Upon pressing the setpoint field box, the pop-up numeric entry pad will appear from which the setpoint can be entered. However, if a profile is running or the timer is enabled, the setpoint fields are locked out from user adjustment.



## 2.2 Chamber Detail



The chamber detail screen includes additional operating parameters beyond the setpoint and process variables shown on the monitor screen. The chamber events can be activated or de-activated from this screen and their current status can be monitored. As on the monitor screen, the setpoints can also be changed from the detail screen when a profile is not active and the timer is disabled.

### Special Fields Description

#### Out%

The output field shows the amount of heating or cooling (humidifying or dehumidifying) that is being done expressed in terms of percent. The display range is from -100 to 100% representing full cooling to full heating for example. A reading of zero means that no cooling or heating is being performed.

#### Event Table

The events are used to control specific chamber functions and optional customer relays. Not all events are used with the ZP(H) Series chamber and are marked as such. The scroll bar to the right of the list box allows the user to view each event through the list.

Next to each event is a check box and indicator light. The check box indicates which events are selected to turn on. The indicator light next to each event shows the status of that event. A green light indicates that the event is on while a dark indicator represents an off status.

## 2.3 Trend Graph



The trend graph displays the setpoint and process variable history over a period of time. The vertical axis determines the range of displayed data while the horizontal axis determines the sample period. The maximum time period allowable is 4 hours.

### Trend Configuration

To adjust the displayed variables, range and sampling period, touch the “Trend Setup” button. The Trend Setup screen will appear with the available adjustment controls.



#### Trend Zero

The zero value sets the minimum range of the vertical access for the trend variables.

#### Trend Span

The span value sets the maximum range of the vertical access for the trend variables.

#### Time(Mins)

The time interval is in minutes and adjusts the displayed time period for the trend. The allowable range is from 10 to 240 minutes.

Trend Points

To adjust what items are shown on the trend, select/deselect the desired items by touching the check box next to each process and setpoint variable.

Once all selections are made, press the “Done” or “Cancel” button to return to the trend screen. Any adjustments made when the “Cancel” button is pressed will be disregarded.

## 2.4 Graphic Monitor

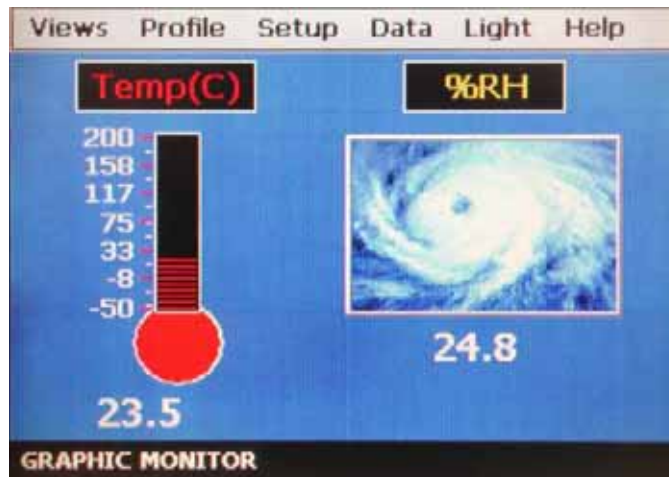

The graphic monitor displays the process variables using graphic symbols, i.e. thermometer for temperature for example. The range of the thermometer can be changed by touching the thermometer. Low and high range adjustment boxes appear at the bottom of the screen. After changing the range(s), touch the thermometer again to accept the changes. The adjustment boxes will close and the thermometer range will be updated.

## 2.5 System Alarms

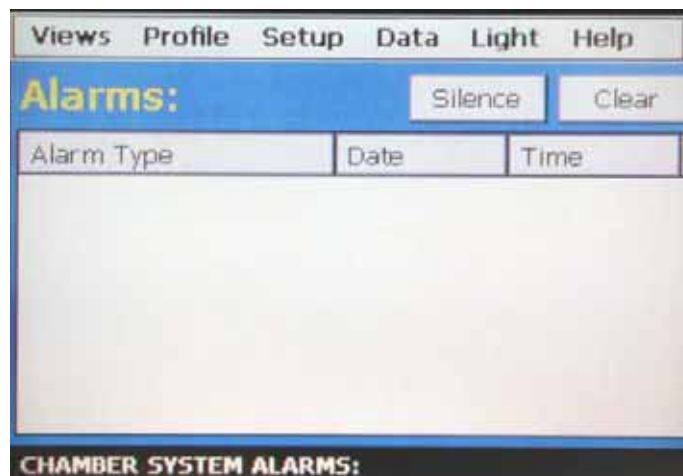

The alarm screen displays any current and previously silenced alarms according to time and date of occurrence. When an alarm occurs, the screen background will turn red to notify the user of a new alarm. Once the alarm is silenced, the screen background will revert to the standard blue background.

Silence

The silence button acknowledges the current active alarms and silences the audible alert.

Clear

The clear button removes all alarms from the alarm list. If an alarm is still currently active, the alarm will return. Only non-active alarms can be cleared.

## 2.6 Profile Status View

The profile status view contains information on the current profile in operation. It is accessed under the profile sub-menu. To view the screen from the main menu, select Profile, Edit/Monitor, Views, Profile Status View.



- 1) Profile Name  
Displays the name of the profile being run.
- 2) Current Profile Status  
Displays the current operating status of the selected profile.
- 3) Temp  
Displays the current temperature inside the chamber.
- 4) TempSP  
Indicates the current target temperature of the step being run.
- 5) %RH  
Displays the current relative humidity level inside the chamber.
- 6) %RHSP  
Indicates the current target humidity level of the step being run.
- 7) Current Step  
Indicates the step number currently being executed.
- 8) Last Step  
Indicates the last step number of the selected profile in operation.

- 9) Step Time Remaining  
Displays the time left within the current step in hours and minutes. A time of 1 minute indicates a time remaining of less than 1 minute
- 10) Profile Time Remaining  
Displays the time left within the profile in hours and minutes. This includes jump steps and recycles.
- 11) Time Running  
Displays the total time the profile has ran in hours and minutes. This includes total step times and time spent in hold.
- 12) Cur Recycle Step  
Indicates the current step number that the profile will jump to when the current step is complete and when recycle count (see below) is greater than 0. A step number of 0 indicates that no jump will take place.
- 13) Recycle Steps Left  
Indicates how many jumps are left from the current step. When the recycle count is 0, no jump takes place and the next sequential step number is executed.

### 3. Single Setpoint Operation

This chapter explains how to operate the chamber in its basic operating mode.

#### 3.1 Single Setpoint Adjustment

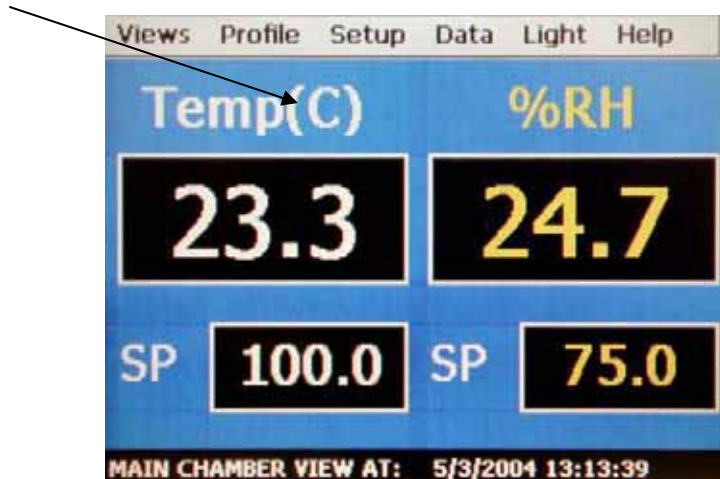

To adjust the setpoint:

- 1) Select either the Chamber Monitor or Chamber Detail screen under the Views menu.
- 2) Input the setpoint temperature (humidity).

Press the setpoint (SP) field box for temperature and/or humidity. The setpoint adjust keypad will pop up on the screen. Enter the desired setpoint value and press the Done button.

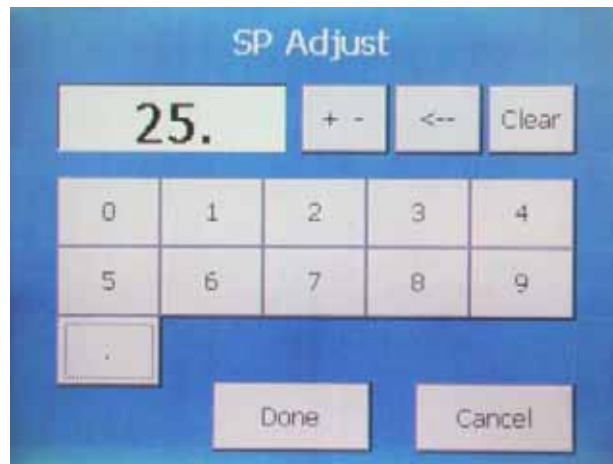

- 3) Turn the Chamber event on, see section 3.2 below.

### 3.2 Event Control (Chamber On/Off)

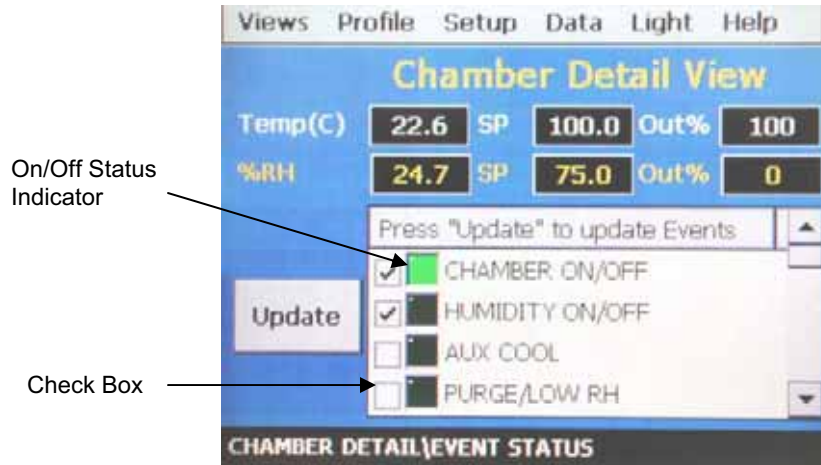

To turn chamber systems and optional customer events on/off:

- 1) Select the Chamber Detail screen under the Views menu.
- 2) Select the events you wish to turn on by checking the check box next to each event in the list box. To turn off events, de-select the check box next to the event.
- 3) Press the Update button to set the new event status. Note that the events will not turn on or off until the update button is pressed.

#### Chamber On/Off

Turns the chamber's air circulators, heating and cooling systems on and off.

#### Humidity On/Off

Turns the chamber's humidity system components on and off. When humidity is turned off, the relative humidity is still measured and displayed; however, no control takes place to obtain the target setpoint.

#### **NOTES** on humidity system operation

##### Temperature Extremes

When operating your environmental chamber at extreme air temperature setpoints, below freezing (0°C / 32°F) or above boiling (100°C / 212°F), the chamber is not capable of controlling humidity. This is due to the physical properties of air and its ability to hold moisture at standard atmospheric pressures when at the extreme temperatures.

To prevent malfunction or damage to the chamber, the EZT-550 control system automatically disables the humidity system components when outside of the valid operating temperature range. The event will remain on; however, once the air temperature within the chamber returns to valid operating temperatures, humidity control will resume at the target setpoint.

### Minimum Humidity Limitations

The standard humidity option provides a lower limit on humidity control relating to a 4.4°C (40°F) dewpoint. The dewpoint refers to the temperature at which the air contains the maximum amount of moisture it can hold. When a surface drops to that temperature or below, condensation can occur. The dewpoint varies logarithmically with temperature and relative humidity. This means that at higher temperatures, a lower humidity level can be obtained because the air can hold more moisture the warmer it becomes.

For example, an air temperature of 85°C (185°F) and relative humidity of 12%, is the equivalent dewpoint of air at a temperature of 5°C (41°F) and 79%. Both of these values are at the minimum achievable dewpoint of the chamber, and thus the minimum achievable humidity at the related temperature. If you were to set the humidity setpoint at 0% for example, the humidity level would never reach 0 since the chamber is not capable of removing any more moisture from the air.

The EZT-550 is programmed to determine what the minimum achievable humidity point is at any given temperature and will control to that limit. Therefore, the system will not overwork itself trying to reach an unattainable point. This prolongs system life and reduces wear and tear on humidity system components. Thus, if you set a setpoint of 0%, you can be confident that the environment within the chamber will remain as dry as possible at any given temperature within the operating range.

## 3.2.1 Chamber Options

The following information covers the use and operation of the optional chamber systems.

### Aux Cooling

The auxiliary cooling system utilizes LN<sub>2</sub> or CO<sub>2</sub> as a boost cooling medium to assist the refrigeration system in lowering the chamber air temperature. It is an inexpensive method for fast cooling transitions without having to make the investment in a high horsepower refrigeration system that may rarely be used.

When this option is installed on the chamber, turn the Aux Cooling event on. When the boost is required during a pull-down, the EZT-550 will turn on the boost cooling solenoids and inject LN<sub>2</sub> or CO<sub>2</sub>, into the chamber to drop the temperature as fast as possible. Once the setpoint is achieved, the boost solenoids will close in order to conserve LN<sub>2</sub> or CO<sub>2</sub> since it is no longer required. To prevent the boost cooling from turning on for normal testing, turn the Aux Cooling event off.

### Dry Air Purge

The dry air purge event has two levels of functionality.

Level 1 - The first level of this option is dry air purge only. The purge only option consists of an air dryer which dries a small volume of air and discharges the dry air within the chamber. This helps reduce condensation on surfaces within the chamber by drying the air. When this event is turned on with the purge only option, the air dryer will run continuously until the event is turned off.

Level 2 - The second level of this option includes the frozen coil option. This option allows the chamber to reach a -29°C (-20°F) dewpoint. This relates to lower relative humidity control. When the frozen coil option is installed and the humidity system is enabled, the dry air purge system is operated in conjunction with the frozen coil automatically by the EZT-550 controller based on the air temperature and humidity setpoints. When required to obtain low humidity levels, the frozen coil and dry air purge systems will start in order to obtain the target setpoint. When no longer required, they will automatically turn off.

You also get the benefit of being able to manually use the dry air purge system by turning the purge event on and off. However, in the case where the frozen coil option is installed, the humidity system must be disabled for the dry air purge to function manually.



Customer Events

The EZT-550 controller has the ability to control up to 12 event output relays. These outputs can be manually turned on and off, and they can also be controlled programmatically through a running profile. You can use them to start and stop devices under test within the chamber, turn signal beacon lights on and off to indicate steps within the test cycle, etc.

**CAUTION** The relay outputs are rated for 125Vac and up to 2A of current. To switch high power loads, the event relay must be used as the “switch” to turn a power contactor on and off to supply power to the test device.

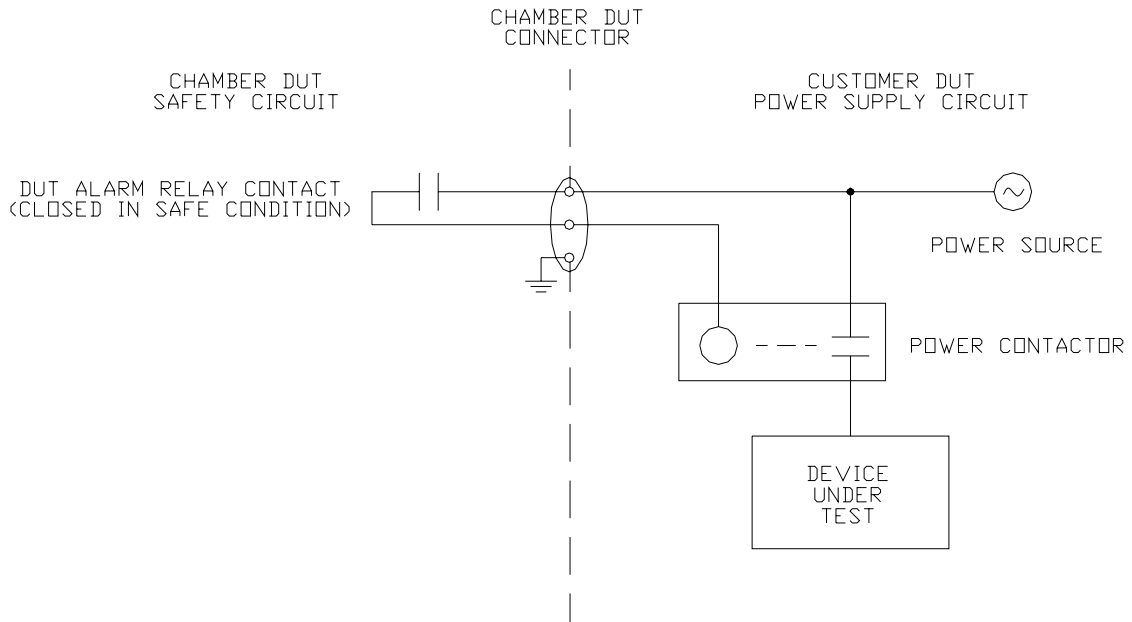

## 4. Profile Operation

This chapter explains how to operate profiles. To access profile utilities, select the Edit/Monitor option under the Profile menu heading.

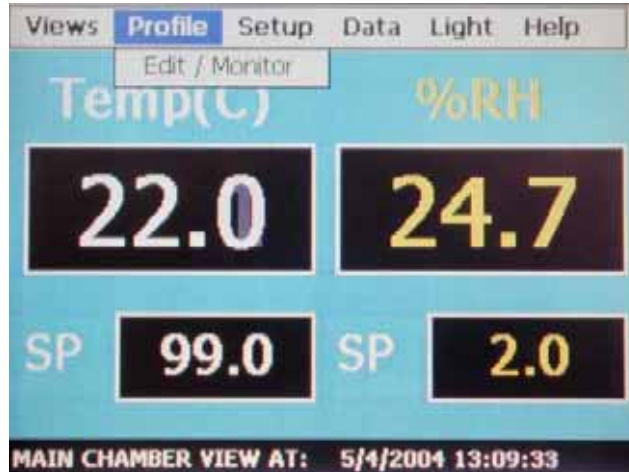

### 4.1 Profile Create/Edit

Profiles are created/edited from the Profile Entry screen located under the Profile menu selection. The following instructions describe the steps involved for programming profiles.

- 1) To create a profile, go to the Profile Entry screen. This screen appears by default upon selecting Edit/Monitor from the main Profile menu.



The profile entry screen can also be selected at any time from the profile Views menu.

- 2) From the Edit menu, select New Profile and select "Yes" to create a new profile.



**Edit Menu Options**

- New Profile: Clears any existing profile entry data so that a new profile can be entered.
- Insert Step: Inserts a step into the current profile at the current step number.
- Delete Step: Deletes the current step.
- Copy Step: Copies the current step data.
- Paste Step: Pastes previously copied step data to current step.
- Select Profile: Opens the file explorer window so that the user can select a profile from the currently saved profiles.
- Save Profile: Saves any changes made to the current profile under the existing name. If no name exists, the user is prompted to enter one.
- Save As: Allows the user to save the current profile to a different name. This is useful for copying profiles in order to make different versions of the same profile.
- Delete Profile: Allows the user to delete the current profile.

**Step Scroll Buttons**



Moves the display back to the previous step.



Moves the display to the next step.

- 4) Input the required step data by touching the field entry boxes. Once touched, the keypad entry screen will pop-up and allow the desired value to be entered.

#### Total Steps

The total steps entry is common to all steps of the profile. It specifies the total length of the profile. The profile can be from 1 to 99 steps in length. This must be set to the correct number of steps in order for the profile to work correctly.

#### Step Events

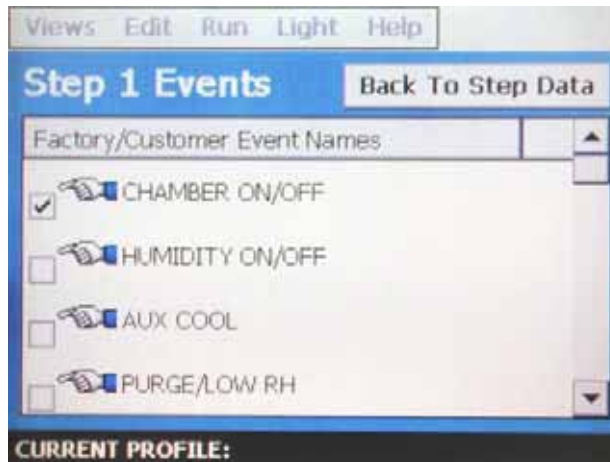

The step events button opens up the events list for the current step. From this window, select the events that are to be on during the step. Once the selections are complete, return to the step entry screen.

**Note:** This must be done for each step individually. Also, for the chamber to operate, the relevant chamber systems must be turned on via the event entry window. Even though a profile may be in operation, if the events are not set, the chamber will not run.

#### TempSP

Target setpoint for air temperature during execution of step.

#### %RHSP

Target setpoint for humidity during execution of step.

#### Hrs: and Mins:

Time length of step in hours and minutes. Note that the time of a step can be zero (0). This is useful for making instant setpoint changes between steps when a ramp is not desired.

#### Profile Recycle

The profile recycle allows the profile to jump between different steps within itself. This is useful for repeating the same profile during extended cycle testing of product.

Recycle# - number of times to jump

Recycle Step – number of step to jump to once current step is complete

- 5) Once you have completed entering all step data for the profile, select Save Profile from the edit menu to save the profile.

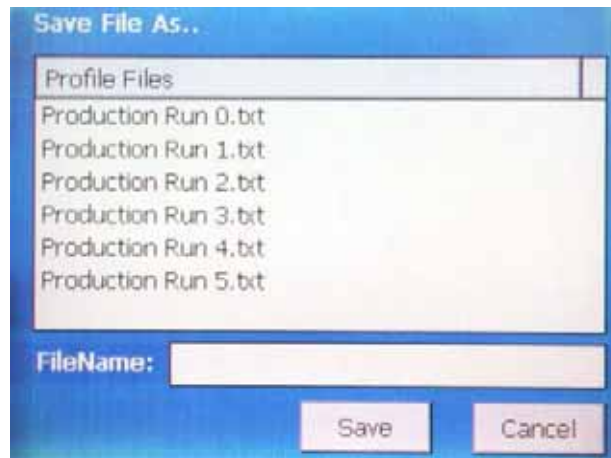

On the save profile window, touch the Filename entry field. An alphanumeric keypad will appear. Enter in the desired filename for the profile and press Done.



The keypad window will close and return you to the save profile window. If the filename entry is correct, press the Save button. The profile is now saved in memory.

## 4.2 Guaranteed Soak Limits

To access the guaranteed soak limits, select Guaranteed Soak from the profile Views menu. The soak limits screen allows you to set the control tolerance for soak steps when in profile operation. When the process variables differ from the setpoints by more than the soak limits, the profile will go into hold and the timer will stop until the process variables re-enter the soak bands. These limits apply to each step in the profile and only need to be set once.



To change the limits, touch the limit entry field. Enter the new soak band via the keypad. Note that setting a band limit too tight, could prevent the profile from operating correctly because the chamber may not be able to control to such a tight band setting. A typical band setting would be 1°C (1.8°F) for temperature and 4% for humidity.

The soak limits are saved with the current profile. When changing the soak band settings, be sure to save the profile in order to update the profile with the new settings. This insures that each time the profile is loaded and run, it will control to the proper band settings.

### Using Guaranteed Soak

To enable the guaranteed soak function, the event must be set for each step that it is operate. The soak can be enabled on temperature, humidity or both for each step. This is done by checking the appropriate box in the Step Events window when creating/editing a profile under the Profile Entry screen.



The guaranteed soak function is disabled by default for each step. Enable it by placing a check in the appropriate check box.

### 4.3 Plot Profile

You can view the currently selected profile by using the Plot Profile utility. This allows you to see if the profile you programmed matches the desired profile. To plot the profile, select Plot Profile from the Views menu under Profiles.



Press the Plot button on the upper right of the screen. The EZT-550 will then generate a graphical representation of your profile.

Note: The Y-axis auto-scales to fit the setpoints within the profile. The X-axis auto-scales to the number of steps in the profile. These values cannot be changed edited.

### 4.4 Start/Stop Profile

To start a profile, one must be selected. The selected profile is shown at the bottom of the screen. To start the profile, select “run” from the Run menu.

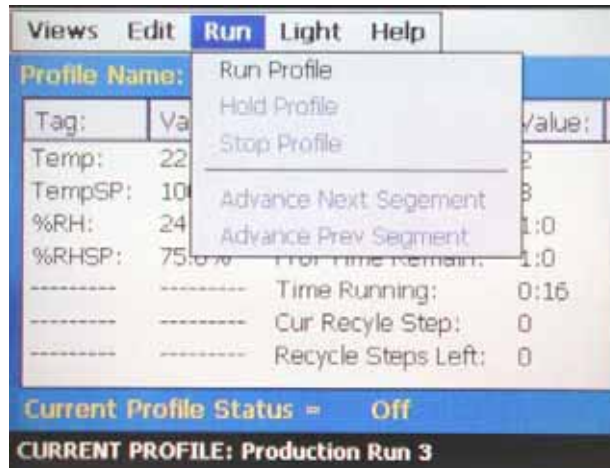

A pop-up window will appear prompting you to enter the step number for which the profile is to start on. The default is step 1.



Use the scroll buttons to adjust the start step if required, and press the Start Profile button. The profile will then be loaded into memory and started once the load is complete. The profile status screen will automatically appear upon starting the profile so that the profiles operation can be observed.



### 4.4.1 Hold/Resume a Profile

At any time during the operation of a profile, the profile can be put into hold. This stops the profile timers; however, it allows the chamber to maintain operation under the current step settings at the time the profile was put into hold. To put a profile into hold, select Hold Profile from the Run menu and select Yes to put the profile into hold.

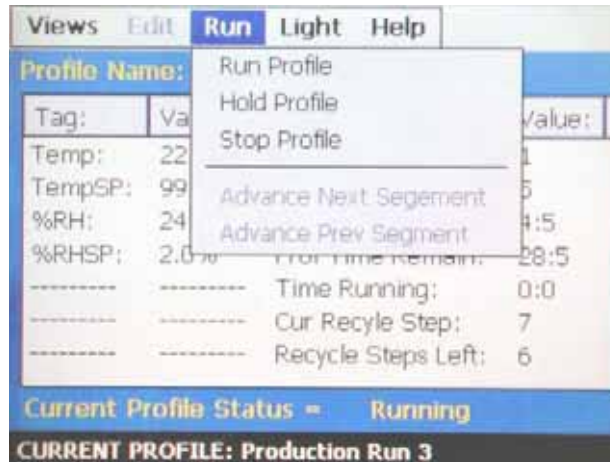

To resume the profile, select Run profile from the Run menu and select Yes to continue the profile from where it left off. Upon a power failure, you can also resume a profile's operation in this manner from the point that power was lost if the power recovery feature is enabled. See section 5.4 for more information regarding power recovery options.

### 4.4.2 Advance Previous/Next Step

The advance step function allows the user to skip certain profile steps or repeat them by advancing to the desired step. To advance to a previous or next step in the profile, the profile must be first put into hold. Once the profile is in hold, the advance step menu items are enabled under the Run menu. By selecting advance previous or advance next, the current step will be decremented or incremented by 1 each time. When the current step number is on the desired step, place the profile back into run and the profile will continue operation from the beginning of the selected step.

## 5. Chamber Setup

This section covers the use of extended controller features that enhance the functionality of your chamber. To gain access to the chamber setup options, select Chamber from the Setup menu.



### 5.1 Control Tuning

The control tuning parameters are used to adjust the chamber's output responses for heating, cooling, humidification and dehumidification. These values have been set by the factory at optimal settings for the chamber. Under most circumstances these values should not require modification. However, under certain conditions, these values may have to be changed to compensate for live loads, etc. Prior to altering these values, be sure to read Section 5.1.1 to get an understanding of how each setting affects control response.

To view and/or adjust tuning parameters, select Control Tuning from the Setup menu.

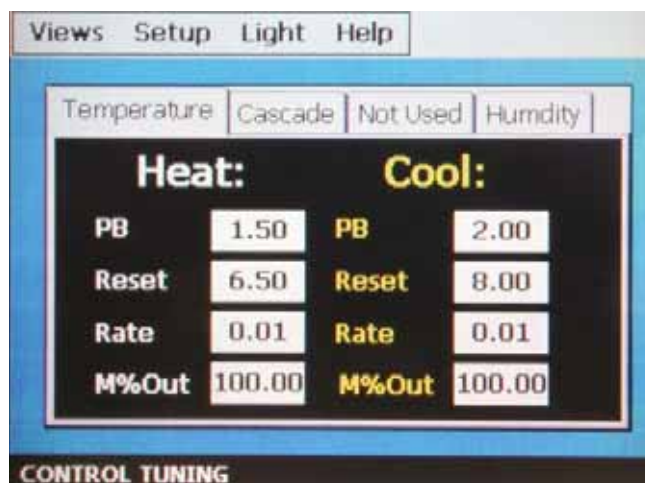

The control loops for temperature, humidity and cascade are shown on separate tabs. By selecting the relevant tab, the parameters for the corresponding control loops are shown.

*PB (Proportional Band)*

The proportional band sets the amount of gain applied to the output based on the difference between the process variable and setpoint. The proportional band entry is a percentage of the input range.

For example, if the input range is 0 to 100 degrees (100 total), a proportional band of 2% is equal to 2 degrees. Thus, as the process variable differs from setpoint through the range of 0 to 2 degrees, the output will go from 0 to 100%. As the process variable approaches setpoint, the output would then drop from 100 to 0% once setpoint is reached.

Note: When the proportional band is set too small, the gain becomes very large and the output response becomes fast and can result in overshoot and oscillation. In contrast, if the band is set too large, the overshoot is suppressed, but an offset may be introduced between the process variable and setpoint.

*Reset (integral action)*

When only proportional action is used, a certain amount of difference (offset) between the setpoint and process variable may remain after the system has reached a stable state. The reset action is used to reduce this offset to zero by adding a small amount to the output periodically. The reset value specifies the time interval between output additions.

Note: When the integral time is too short, the integral action becomes large, resulting in an overshoot of a long period. In contrast, when the integral time is too long, it takes a long time for the process variable to reach setpoint.

*Rate (derivative action)*

Rate is a function to adjust the output in response to a disturbance of the process variable in relation to the setpoint. It "anticipates" the change and adjusts the output accordingly. The rate value specifies the amount of action to apply.

Note: Only a very small amount of rate is required. In some instances, no rate at all may be needed. It is recommended that rate values be kept in the 0.01 to 0.10 range. Too large of a value causes the output to respond to a disturbance very quickly and cause instability in the control action.

*M%Out*

The maximum output percentage is used in special instances only. It is used for fast change rate systems which have high powered heating and cooling systems. The heat and cooling systems are divided into stages for these systems and the maximum output percentage determines when the stages overlap. These values should be kept at 100% for optimum performance of your chamber. Only special systems require this setting to be changed. Consult your chamber manual for information regarding the chamber's performance.

## 5.1.1 How to Adjust Tuning Parameters

Should you have an application where the standard factory parameters do not provide acceptable control, the following guidelines will assist you in adjusting the PID settings for improved control.

Note: When making changes to the PID parameters, it is necessary to give the system enough time for the new settings to take affect. It can take up to 15 minutes to see the results of an adjustment. Also, tuning the system to operate at one specific point may cause erratic control at other points. Choose your settings wisely.

### Temperature

- 1) Set up your test load and turn any live loads on.
- 2) Set the setpoint for ambient, 24C (75F). This is the most difficult temperature control point due to the fact that very little heating or cooling is needed to maintain it.
- 3) Set the reset and rate values for heating and cooling to zero.
- 4) Starting with PB bands of 1.00, increase the PB bands for heating and cooling until the oscillation around setpoint stabilizes, i.e., little to no overshoot beyond setpoint. (approximately 0.3C (0.5F) max)
- 5) Add reset to both heating and cooling starting at a value of 8.00. Reduce the values until oscillation begins, and then increase them slightly to reduce the oscillation. Some cases may require the values to be increased from the initial 8. Typical values are between 5.00 and 10.00.
- 6) A typical setting for the rate will be approximately 0.4% of the reset value.
- 7) Verify operation of the chamber at the desired points. Some minimal adjustments may be needed for specific points.

### Humidity

- 1) Set up your test load and turn any live loads on.
- 2) Set the setpoint for ambient, 24C (75F), and the humidity for 50%. This is the most difficult humidity control point due to the fact that very little moisture is needed to maintain it.
- 3) Set the reset and rate values for humidification and dehumidification to zero.
- 4) Starting with PB bands of 20.00, increase the PB bands until the oscillation around setpoint stabilizes, i.e., little to no overshoot beyond setpoint. (approximately 1% max)
- 5) Add reset starting at a value of 8.00. Reduce the values until oscillation begins, and then increase them slightly to reduce the oscillation. Some cases may require the values to be increased from the initial 8. Typical values are between 6.00 and 10.00.
- 6) A typical setting for the rate will be approximately 2.5% of the reset value.
- 7) Verify operation of the chamber at the desired points. Some minimal adjustments may be needed for specific points.

Note: Typically, larger PB bands require larger rate values to make the system respond to temperature changes faster in order to maintain setpoint at extreme conditions. Most overshoot conditions can be adjusted by altering the reset value. The proportional band determined at ambient is generally acceptable throughout the entire chamber control range.

## 5.2 Device Under Test (DUT)

The device under test settings provide product protection for your equipment.



The high and low limit fields set the maximum and minimum temperature that the product is allowed to experience. If the temperature of the product goes above or below the preset values, the chamber will shut down and the audible alarm will sound. In order for the chamber to restart, the temperature of the product must re-enter the “safe” range.

### Notes on using the product safety:

**CAUTION** In order for the product safety to work correctly, you must place the DUT temperature sensor on your product so that it can sense the temperature.

**CAUTION** The DUT safety connection on the chamber is provided as an interface to your product’s power controller. The connection is a dry contact rated at 125Vac and 2A. Do not exceed the contact ratings. To switch high power loads, use the DUT safety relay to supply power to a high power contactor to provide product power.

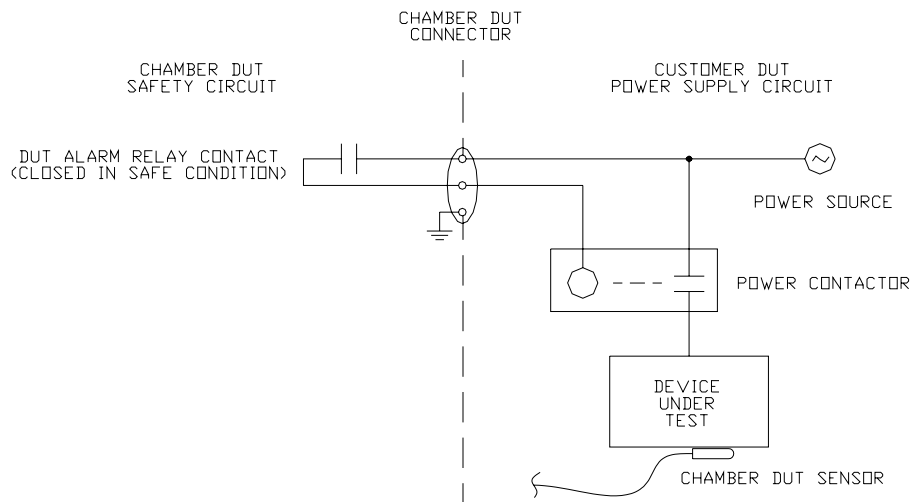

### Cascade Control Feature

The cascade button enables and disables cascade control. The cascade control function uses the product sensor as the primary temperature control sensor. When cascade is enabled, the EZT-550 controls the product temperature rather than air temperature. This guarantees that your product reaches setpoint.

### Tuning

The cascade loop has its own tuning parameters. These parameters can vary widely based on the product and location of the product sensor. It is recommended that the PB be kept relatively small for tight control (0.5 to 1.5) and the reset be set to a large value (15 to 25) to prevent oscillation. Due to the fact that most product loads respond slowly to air temperature changes, it is recommended that the rate is not used (value of 0).

### Notes on using cascade control:

**CAUTION** When cascade control is enabled, the air temperature will exceed setpoint in order to get the product to temperature as quickly as possible. The DUT high and low limits become the maximum and minimum achievable air temperatures. Be sure that your product will not be damaged by exposure to these air temperatures during transitions prior to enabling cascade control.

## 5.3 Event Tag Names

The names of events can be changed to describe what function they perform. Certain events are predefined by CSZ for use with chamber systems. However, the customer events are specific to your use and therefore can be changed to describe their function. To alter event names, select Event TagNames from the Setup menu.

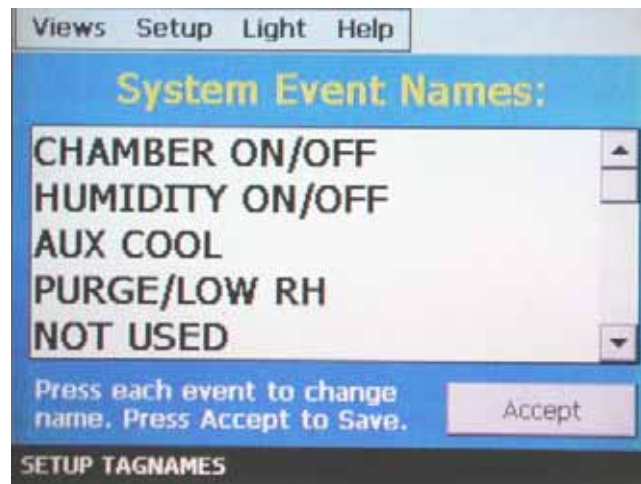

To change the name of the event, select the event by touching its current tag name. The pop-up keypad will appear allowing you to enter a new description. Once complete, select Done and the new name will appear in the event tag name list box. Once all changes have been made, press the Accept button to store the change to memory.

## 5.4 Power Recovery

The power recovery screen allows you to select how the chamber is to respond to a power outage once the power is restored. To adjust the recovery action, select Power Recovery from the Setup menu.

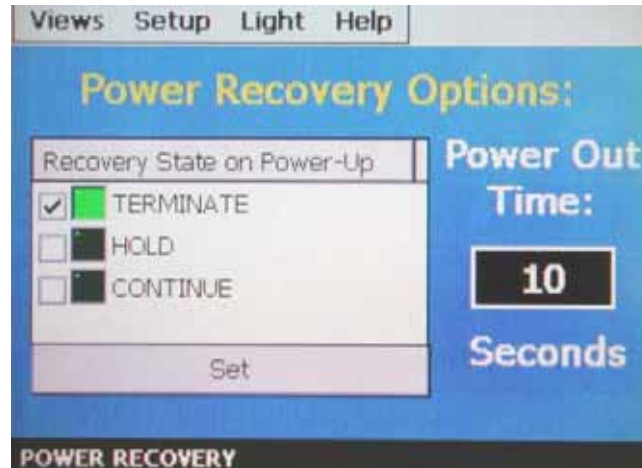

### Recovery State on Power-Up

Set the recovery mode for the chamber. Select the desired mode by checking the appropriate check box and press the set button.

- Terminate**      Select terminate to have the chamber default to the off state on power-up. If a profile was active prior to the power outage, the profile will also be stopped.
- Hold**            Select hold to have the chamber return to operation at the same point it was prior to the power outage. If a profile was running, the profile will still be active; however, it will remain in hold until manually set to continue.
- Continue**        Select continue to have the chamber pick-up where it left off on loss of power. If a profile was running prior to the power outage, it will resume where it left off and continue through the rest of the profile.

### Power Out Time

The power out time sets the time in seconds that power is allowed to be off for the hold and continue recovery actions to execute. If the power remains off longer than the set period, the chamber will default to the off state (terminate) on power-up.

## 5.5 Timer Setup

The timer function allows you to program your chamber to start and stop automatically at predetermined times. The timer can be set to initiate a profile or run the chamber at steady state conditions. To access the timer, select Timer Setup from the Setup menu.



- 1) Begin by setting the timer mode of operation. Press the Mode Setup button to access the timer mode settings screen.

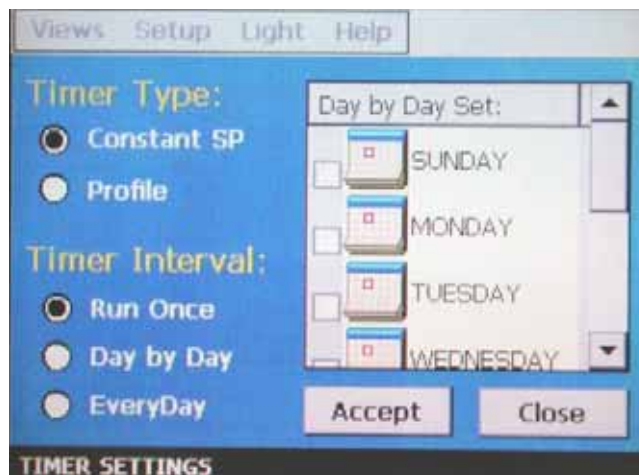

### Timer Type

The timer type selection determines what function the timer is to perform.

**Constant SP:** Operates the chamber at the current setpoint entered for temperature (humidity) prior to turning on the timer.

**Profile:** Starts the last profile that was run prior to turning on the timer.



Timer Interval

The timer interval specifies when the timer is to perform the specific function selected via the timer type.

- Run Once: Starts/Stops the chamber at the specified time/date.
- Day-by-Day: Starts/Stops the chamber at the specified times on multiple specified days. When selected, the days to operate are chosen by checking the appropriate check box next to each day the timer is to operate.
- Everyday: Starts/Stops the chamber at the specified times every day.

**Note:** When “run once” is selected, a time and date must be specified for the timer to operate. When either of the day intervals are selected, only the start/stop times need to be specified.

Once all settings are made, press the Accept button to store any changes and press Close to return to the main timer screen. If the Close button is pressed prior to accepting any changes, the changes will be lost.

- 2) If the timer type is set to “profile”, then skip to step 3. If the timer type is set to constant, then the events must be set as required. To set the appropriate events, press the Event Selection button to access the Timer Events screen.

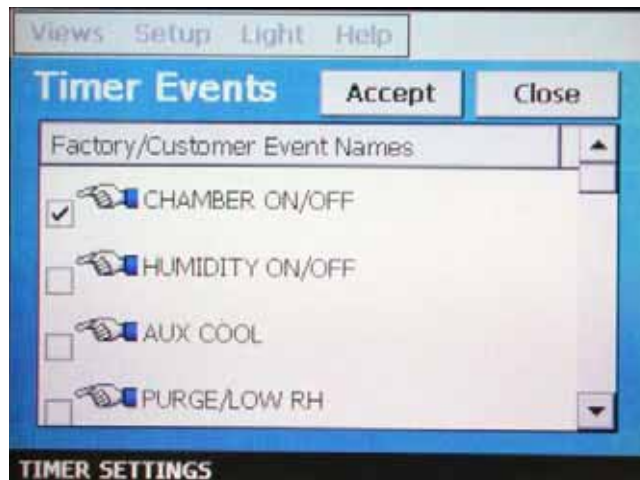

Select which of the chamber systems and events you wish to activate when the timer executes. Note that if you do not turn on the chamber events, the chamber will not run when the timer executes. Once the desired events are selected, press the Accept button to save the changes. Press the Close button to return to the main timer screen. If the close button is pressed prior to accepting any changes, the changes will be lost.

**Note:** The timer events do not have affect when the timer type is set to profile. When the timer starts a profile, the profile retains control of all events and controls them accordingly step by step.

- 3) Set the start and stop times and dates for the period in which the chamber is to operate.



Start/End (H:M) Start and stop times for the timer in hours and minutes. Note that the hours are expressed in military time, i.e., 00-24 hours.

Start/End (M/D) Start and stop dates for the timer in months and days. Note that the year is not required. The timer will start and stop based on a match of the month and day.

**Note:** When the timer type is profile, the stop time and date does not have affect. Once a profile is started, it will run until complete or stopped by the user.

- 4) Once all, settings have been made, press the Timer On/Off button. When the timer is off, the button will read "Timer Off" and the green indicator light will be off. When the timer is enabled, the button will read "Timer On" and the green indicator light will illuminate.

**Note:** When the timer is enabled, the timer will assume control of the chamber from that point. The user is locked out from making setpoint adjustments and running profiles. To regain control, the timer must be turned off.

## 5.6 Defrost Settings

The defrost settings are for special systems with a hot-gas defrost option. The standard ZP(H) series chamber does not utilize this feature. The menu item is therefore disabled.

## 6. Datalogging

This section describes the operation of the on-board datalogging feature and the on-line history viewer. To access the data logging features, select System Logger from the Data menu.

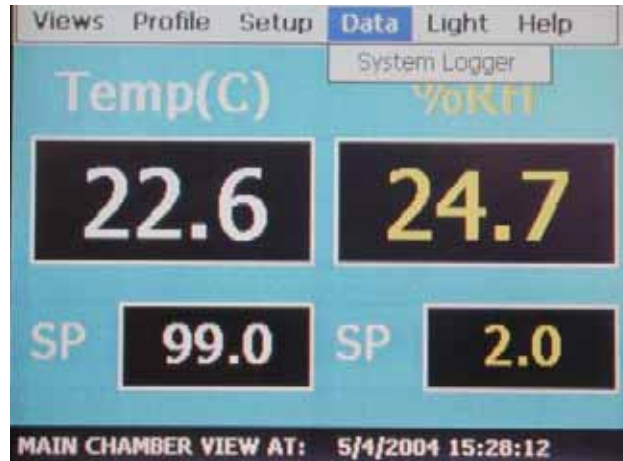

### 6.1 Start/Stop Datalogging

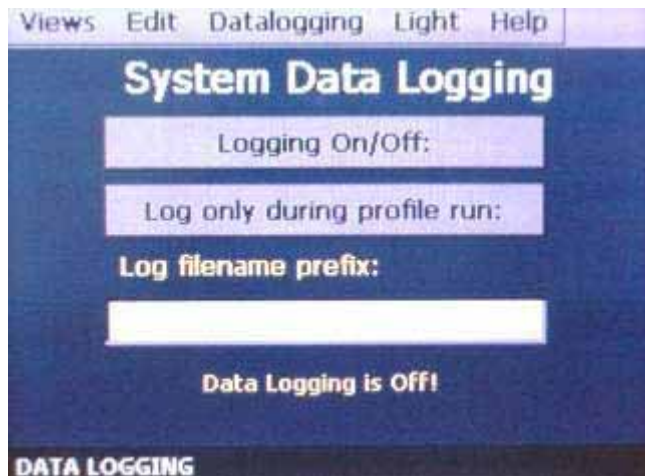

The data logging function, when enabled, records the process variables and setpoints on a fixed 1 minute interval to the memory stick. Note that the memory stick must be installed or the data logging function will be inoperative.

#### Logging On/Off

When logging is on, the EZT-550 continuously logs data around the clock. The data is stored to files named with the date/time that the file was created. Thus, at midnight each day, a new file is created with that day's date and time at which it was started. Each file consists of 1440 points which equates to 1440 minutes, a period of 24 hours. The files are stored in commonly used .csv format.

Log Only During Profile Run

When the log during profile run is selected, the data logging only operates when a profile is running. This makes it easy to determine the start and end of a profile from within a log file. Note that a new log file is still created each day; however, since it corresponds with the profile operation, you know the data is from the desired profile run.

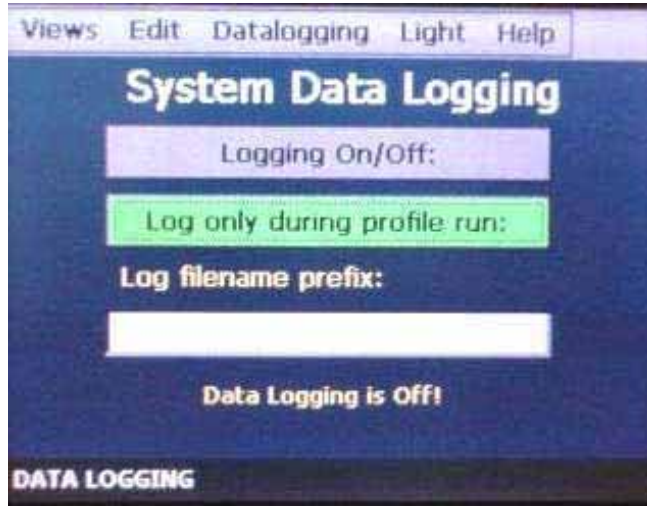

Log Filename Prefix

The file name prefix is a description you can set to identify the log files easily in response to an operational period, profile run, etc. To set the prefix, data logging must be turned off. Set the prefix by touching the filename field. A keypad will appear allowing you to enter the prefix. Once the prefix is set, turn logging back on by selecting the desired logging option.

## 6.2 View Log File

To view a log file stored on the memory stick, select Open History File from the Datalogging menu on the logging screen.



- 1) Select the desired log file from the pop-up list box.

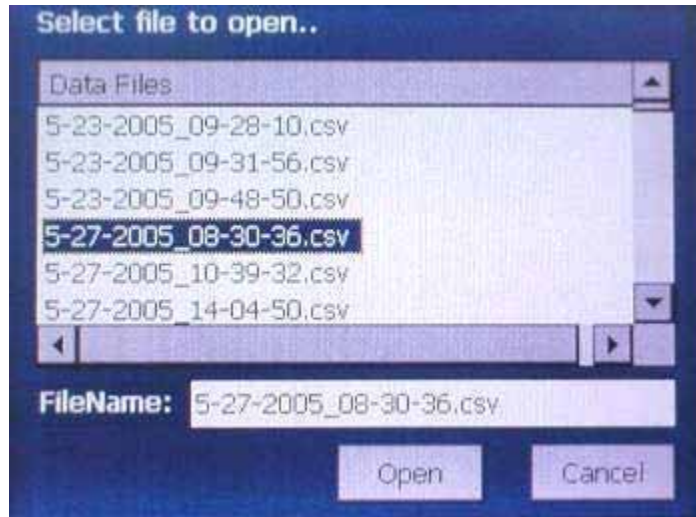

Touch the desired file name in the data files window and touch the Open button.

- 2) Select History Plot Time Setup from the Datalogging menu to configure the time period for the trend prior to plotting.



StartPlot/EndPlot

Specifies the time in hours and minutes for the start and stop of the plot. This allows sections of the file to be viewed for "zooming in" on certain areas. The file start and stop dates and times are provided for reference when setting the time period of the trend. The time period defaults to the span of each history file when they are opened.

- 3) Select History Plot Channel Setup from the Datalogging menu to configure which logged data points are to be displayed in the plot.

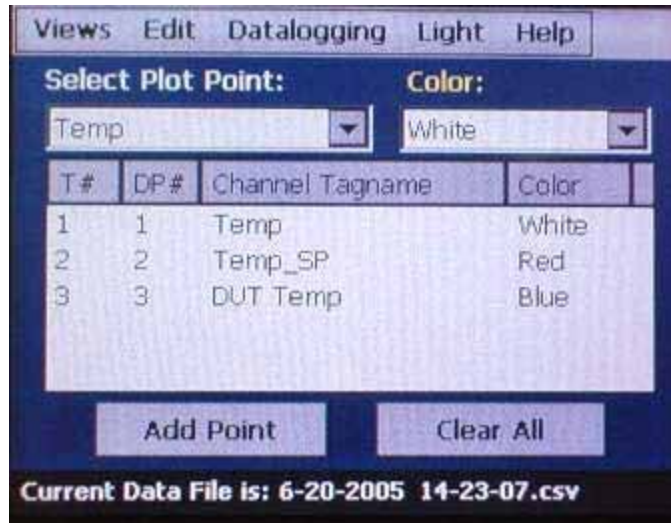

Plot Points

Specifies which points will be displayed on the plot. The selected points default to all when a history file is opened. To select only specific points, press the Clear All button to remove the current selections. Select the desired point and color for the point via the drop down selection boxes and press the Add Point button.

- Once the setup is complete, select Plot History Data from the Datalogging menu. The EZT-550 will plot the data according to the previously selected setup. This may take up to 10 seconds depending on plot size.

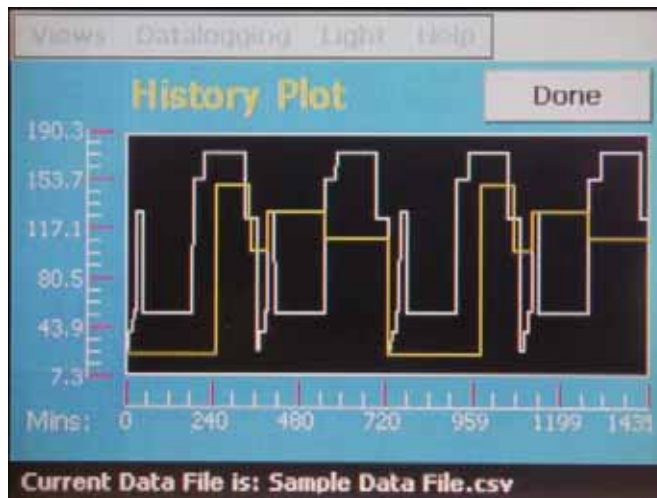

- Press Done when finished.

## 6.2.1 Deleting Log Files

Data files can be deleted one-at-a-time by selecting “Delete Data File” from the Datalogging menu. The previously opened data file is then deleted from the memory stick. Note, to delete more than one file, each file must be individually opened and then deleted.

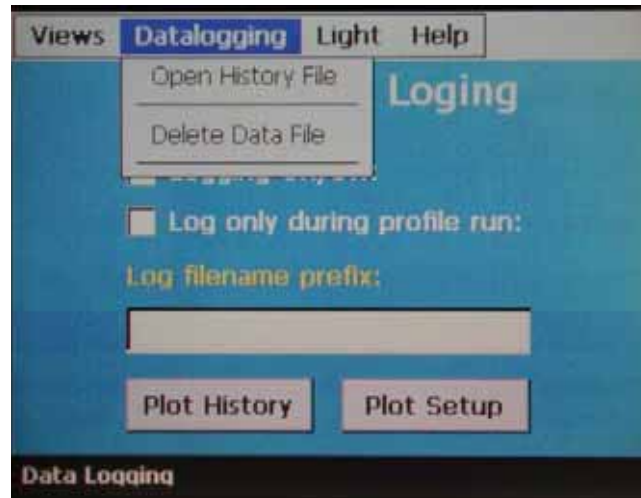

## 7. System Maintenance

System maintenance options are available from the Chamber Setup menu. To access system maintenance, select System Maintenance from the chamber setup menu.



Note: Prior to entering system maintenance, all automatic chamber operations must be stopped. This includes, data logging, profiles and timer operation.

Upon selecting system maintenance, a pop-up window will alert the user that the chamber will be taken off line.

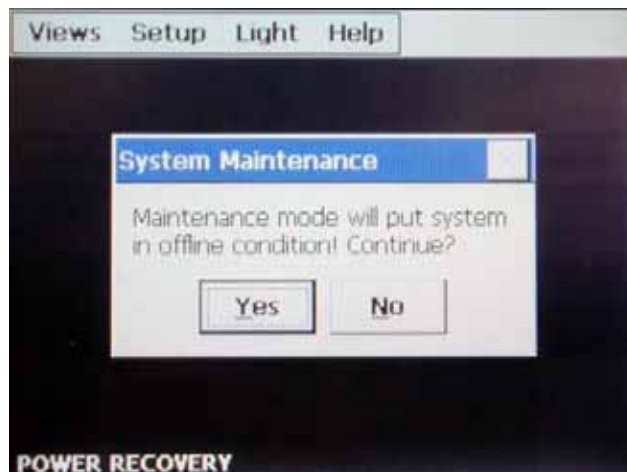

The user can select "No" to return to the chamber setup menu without shutting down any current operations. If the user selects "Yes", all operating systems of the chamber will stop.



## 7.1 Set Date/Time

The date and time can be adjusted by selecting Set Date/Time from the maintenance setup menu. The current date and time will be displayed in the field entry windows.



To make adjustments, touch the desired field entry box. The pop-up keypad will appear allowing a new value to be entered. Once all corrections are made, press the Set Time button. A message window will appear to acknowledge that the new date and time have been accepted. Press OK to close the message window.

### Notes on clock operation:

- Time set:* The time is set in 24 hour (military time). The day of week must be set correctly in order for the day-by-day timer to function correctly.
- Battery back-up:* The clock is battery backed for a period of approximately 30 days. If power is removed from the chamber for more than 30 days, the clock will have to be reset. Power must remain on the chamber for a minimum of 10 hours in order for the battery to fully recharge.
- Daylight Savings:* The clock does not automatically adjust for daylight savings time. The clock must be manually set to the correct time when required.

## 7.2 Level 1 (User) Security Options

To access security level 1 settings, the correct password must be entered. To enter the password, select Password Entry from the setup menu. Touch the password entry field to access the keypad. Enter the level 1 security passcode and press OK. Press the Accept Password button. If the password is correct, the disabled menu items will be activated. If the password is incorrect, a message box will appear to notify the user of an incorrect password. (See **Appendix A of this manual for your passcode**)



### 7.2.1 Degrees C/F Selection

The EZT-550 can display temperatures in either degrees C or F. To change the units, select Degrees C/F from the setup menu.



Press the appropriate button to select the desired units. A message box will appear to acknowledge the units change. Press OK to close the window. The green indicator lamp in the selected units button will be illuminated once selected.

**CAUTION** When changing display units, profile setpoints will not be converted between units. Separate profiles are required for each temperature range. Equipment damage may result if profiles of alternate units are used.

## 7.2.2 Maintenance Counters

The maintenance counters provide service interval alerts for chamber components. When a component exceeds its service interval, a notification alarm is generated. In order to clear the alarm from the system alarm screen, the maintenance counter must be cleared. To access the maintenance counters, select Maintenance Counters from the setup menu.

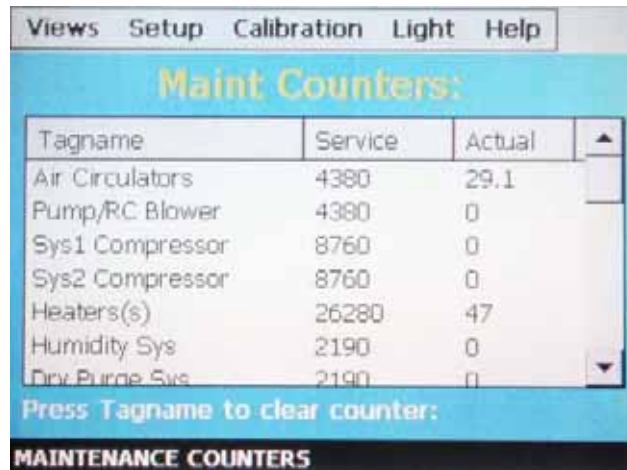

| Tagname         | Service | Actual |
|-----------------|---------|--------|
| Air Circulators | 4380    | 29.1   |
| Pump/RC Blower  | 4380    | 0      |
| Sys1 Compressor | 8760    | 0      |
| Sys2 Compressor | 8760    | 0      |
| Heaters(s)      | 26280   | 47     |
| Humidity Sys    | 2190    | 0      |
| Dry Purge Sys   | 2190    | 0      |

Press Tagname to clear counter:

**MAINTENANCE COUNTERS**

The maintenance counters provide hours of operation monitoring for items such as air circulators and compressors as well as cycle counts for solenoids, number of starts for compressors, etc. The service interval is fixed at the factory for each component based on the required service interval. To clear a counter, select the counter by touching the related component name. A message box will appear to verify the clear operation. Select "Yes" to clear the counter and "No" to cancel.

The maintenance counters minimize unnecessary service by monitoring actual usage of the equipment rather than using a fixed service interval. See your chamber manual for information regarding the types of service to be performed for the different system components.

## 7.2.3 Calibration

The calibration menu provides access to the analog input and output ranges for calibration. Select the desired input or output from the calibration menu in order to view its settings.

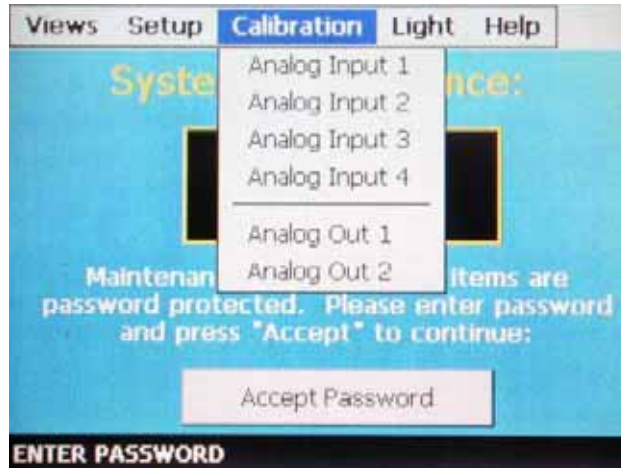

### 7.2.3.1 Analog Input Calibration

There are up to 3 analog inputs used on the ZP(H) series chamber. Note that analog input 4 is shown; however, it is not available for use and its settings have no affect on the operation of the chamber. The three analog inputs are configured as follows:

#### Analog Input 1

Air Temperature:

Input Type: RTD  
 Input Range:  $-100^{\circ}\text{C}$  ( $-148^{\circ}\text{F}$ ) to  $500^{\circ}\text{C}$  ( $932^{\circ}\text{F}$ )  
 Accuracy:  $\pm 0.2\%$  of full scale  $\pm$  LSB ( $\pm 1.35^{\circ}\text{C}$  /  $2.43^{\circ}\text{F}$ )

#### Analog Input 2

Device Under Test (DUT) Temperature:

Input Type: RTD  
 Input Range:  $-100^{\circ}\text{C}$  ( $-148^{\circ}\text{F}$ ) to  $500^{\circ}\text{C}$  ( $932^{\circ}\text{F}$ )  
 Accuracy:  $\pm 0.2\%$  of full scale  $\pm$  LSB ( $\pm 1.35^{\circ}\text{C}$  /  $2.43^{\circ}\text{F}$ )

#### Analog Input 3

Humidity (ZPH series only):

Input Type: 0-10Vdc  
 Input Range: 0 to 100% relative humidity  
 Accuracy:  $\pm 0.2\%$  of full scale  $\pm$  LSB ( $\pm 0.22\% \text{RH}$ )

The input types are fixed and cannot be changed. If replacing sensors, be sure to replace with the same type.

**How to Calibrate Analog Inputs 1 and 2 (Air and DUT Temperature)**

- 1) Select Analog Input 1 or Analog Input 2 from the Calibration menu. The calibration window for the input will appear showing the minimum and maximum range, and the current value of the input.

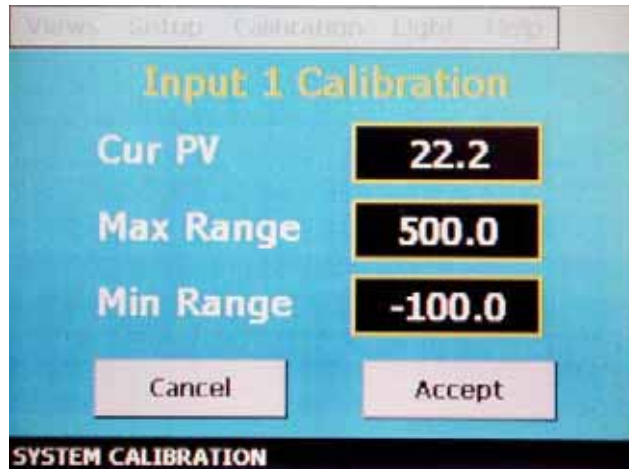

- 2) Disconnect the sensor leads from the analog input on analog input card 1. The input card is connected to the CPU module on the electrical sub-panel located beneath the chamber door behind the front cover.

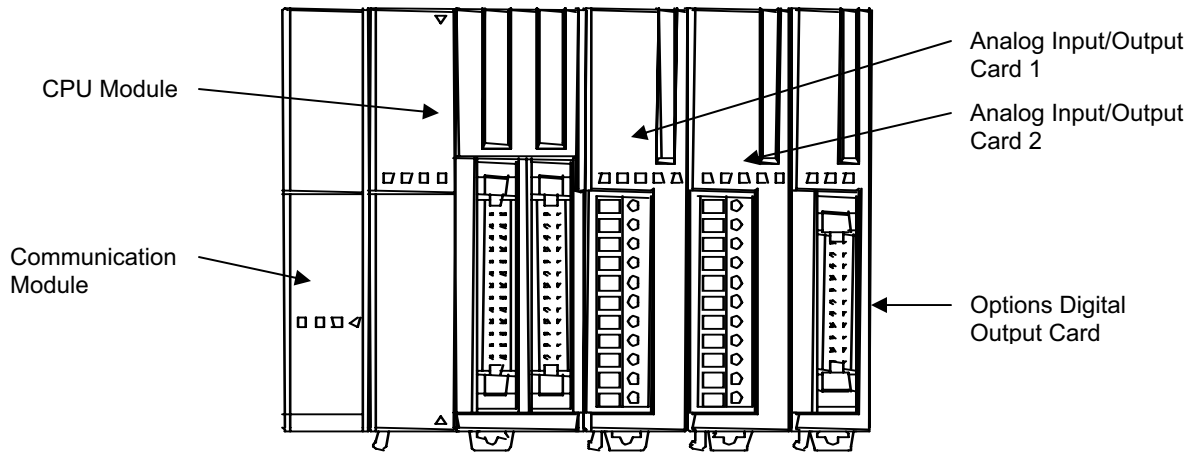

Note: Analog input/output card 2 and the digital output card may not be present on all chambers. They are installed based on options provided with the chamber.

- 3) Connect the leads from the calibration source to the input terminals.

ANALOG INPUT/OUTPUT  
CARD 1 CONNECTOR

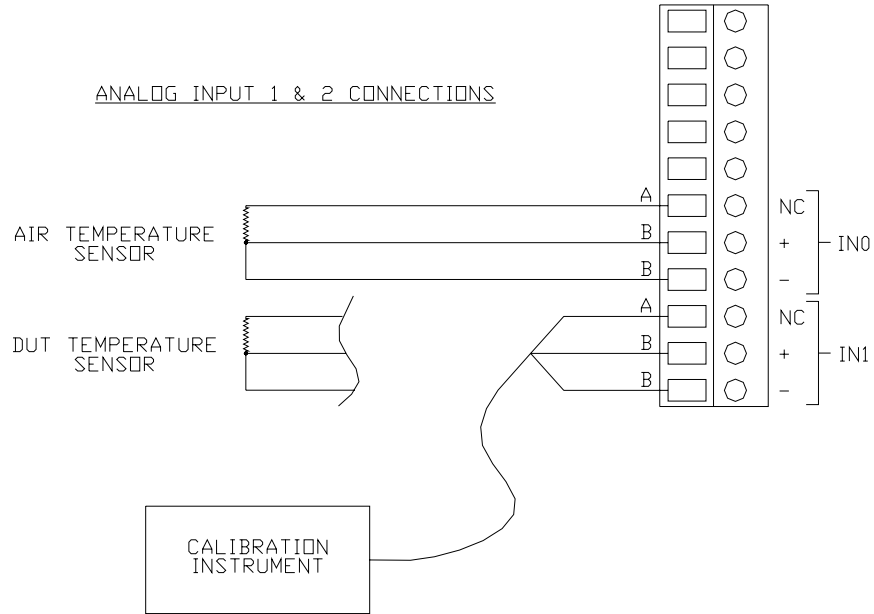

ANALOG INPUT/OUTPUT  
CARD 2 CONNECTOR

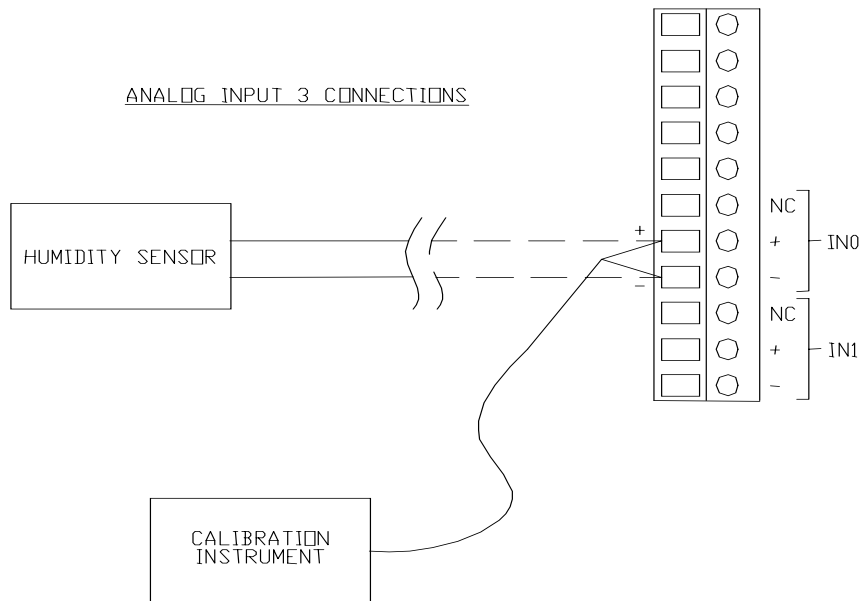

- 4) Using the calibration source, input the desired calibration minimum and maximum temperature(s). Allow the process variable to stabilize for at least 30 seconds prior to making any adjustments. If an adjustment is needed, adjust the minimum or maximum range value accordingly.

For Example:

- 1) Calibrator set to input low of  $-73^{\circ}\text{C}$
- 2) Current PV reads  $-72.5^{\circ}\text{C}$  (difference of  $0.5^{\circ}\text{C}$ ).
- 3) Subtract the difference ( $0.5^{\circ}\text{C}$ ) from current minimum range value and enter that temperature as the new minimum range. If the current minimum range value is  $-100^{\circ}\text{C}$  for example, the new minimum range value will be  $-100.5^{\circ}\text{C}$ .

The same method applies for calibrating the high range. Either add or subtract the difference between the current process value and calibration reference value to the range value to correct for any offset in the input circuit.

- 5) Once all adjustments are made, disconnect the calibration source from the input and reconnect the sensor leads. Verify that the input reads correctly.
- 6) After verifying that the input reads correctly, press the Accept button to save the changes. Upon accepting the changes, the calibration window will close. To exit without saving changes, press the Cancel button.

### 7.2.3.2 Analog Output Calibration

There are up to 2 analog outputs available on the ZP(H) series chamber. The 2 analog outputs are configured as follows:

Analog Output 1

Air Temperature:

Output Type: 0-10Vdc  
 Output Range:  $-100^{\circ}\text{C}$  ( $-148^{\circ}\text{F}$ ) to  $500^{\circ}\text{C}$  ( $932^{\circ}\text{F}$ )  
 Accuracy:  $\pm 0.2\%$  of full scale  $\pm$  LSB

Analog Output 2

Relative Humidity (ZP(H) series only)

Output Type: 0-10Vdc  
 Output Range: 0 to 100% relative humidity  
 Accuracy:  $\pm 0.2\%$  of full scale  $\pm$  LSB

The output ranges can be adjusted to match the input range of a particular instrument connected to them.

**How to Calibrate Analog Outputs 1 and 2 (Air Temperature and Relative Humidity Retransmit)**

- 1) Select Analog Output 1 or 2 from the Calibration menu. The calibration window for the output will appear showing the minimum and maximum range settings.



- 2) Set the minimum and maximum range values to the desired range for the output by touching the field entry box and entering the value via the pop-up keypad.
- 3) Connect the output to a chart recorder or other instrument that is being used to monitor the output.

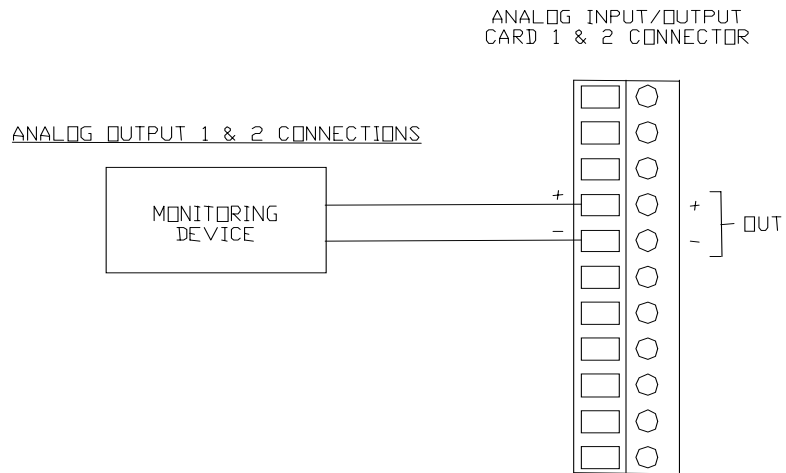

- 4) Press the Zero button to retransmit the minimum output value. Adjust the input of the chart recorder, or other instrument connected to the output, to read the minimum range value.
- 5) Press the Span button to retransmit the maximum output value. Adjust the input of the chart recorder, or other instrument connected to the output, to read the maximum range value.
- 6) Once all adjustments are made, press the Accept button to save the changes. To exit without saving changes, press the Cancel button.



### 7.2.3.3 Touchscreen Calibration

After extended use and many hours of operation, it may be necessary to recalibrate the touchscreen of the EZT-550. A typical sign that the screen may be out of adjustment, is inaccurate responses when attempting to press buttons, check boxes or adjust fields on the display. The calibration utility is provided in order to readjust the screen when this happens.

**Note:** Even after calibration, some fields may require finesse to operate. Check boxes require precise presses even when the screen is in full calibration. Most response issues result from “fat-fingering” the display. Use the tip of your finger or a stylus if necessary to operate the unit.

To access the screen calibration utility, select USB\Touch Interface from the Setup menu.



Push the “Calibrate Touch” button.



From the System settings window, touch the “Calibrate” button to start the calibration utility.



Crosshairs will appear on the screen. At each crosshair position, touch the screen to set the calibration position. The calibration requires five points, the center and four corners. Once complete, the calibration utility will exit and return to the System settings window.

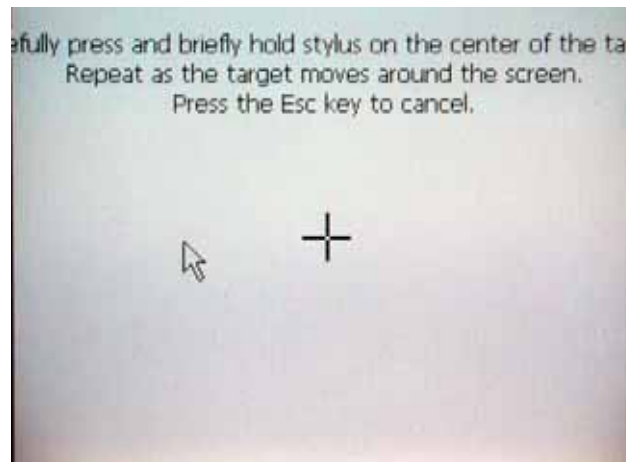

Use the scroll arrow button in the Systems settings window to scroll to the right until you see the Save tab. Touch the Save tab and press the “Save registry” button. This will store the calibration parameters in memory. If the settings are not saved, the changes will be lost when power is cycled to the unit. Press the “OK” button on the upper right corner of the System settings window to close the window and return to System Maintenance.

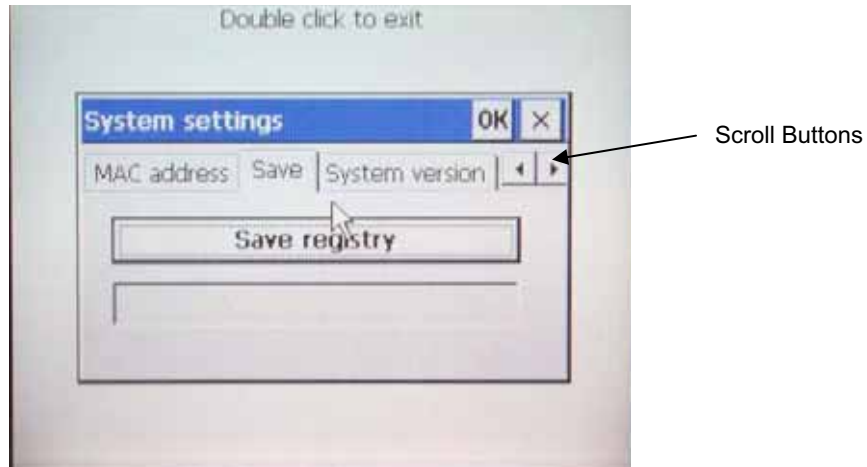

### 7.3 Factory Security Options

The factory level of settings are for Cincinnati Sub-Zero personnel and its affiliates. These settings affect chamber operations and safeties and are not meant for the end user. Any modification of these settings without written authorization from Cincinnati Sub-Zero will void the chamber warranty.

#### 7.3.1 Setpoint Limits

The setpoint limits restrict the minimum and maximum setpoints for temperature and humidity that can be entered. These values are set by the factory to the safe operating range of the chamber.

#### 7.3.2 Startup Configuration

The startup configuration settings tell the EZT-550 how to initialize the specific chamber systems that are present on the chamber. This affects chamber options and control settings relevant to those systems.

## 8. File Access

In order to retrieve data files from the EZT-550's memory stick, all that is required is a computer with a standard USB port. Insert the memory stick into the computer's USB port. The computer's operating system will automatically detect the memory stick and assign a drive letter to it. Access the memory stick just like you would your computer's hard drive.

### 8.1 Opening Files

The memory stick will contain a file directory called Data Files. Open the Data Files directory to view the available historical log files.

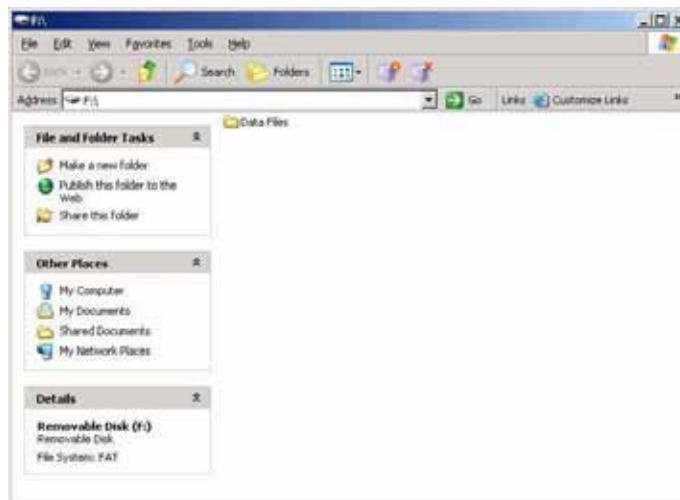

The data files are stored in ".csv" format. The data files can be opened by any spreadsheet program such as Microsoft Excel. It is recommended that the data files be deleted from the memory stick once they have been retrieved. This frees memory for future files on the memory stick.

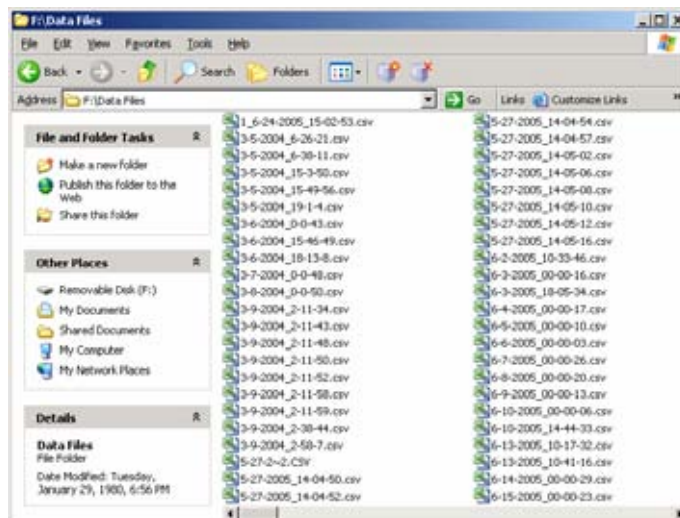

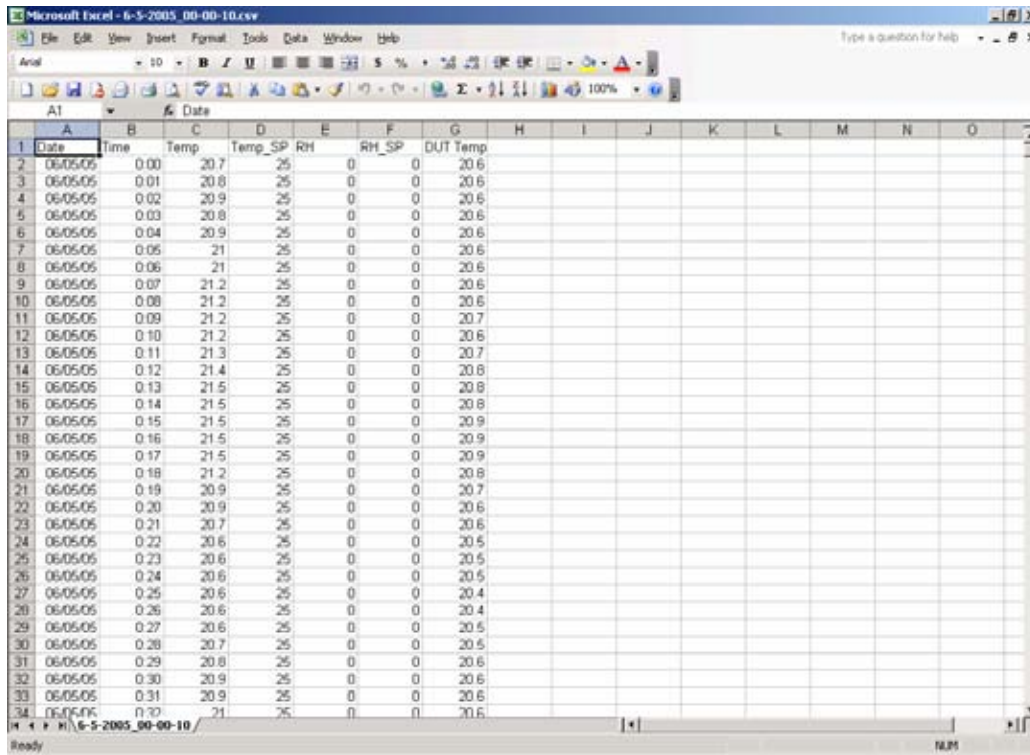

| 1  | Date     | Time | Temp | Temp_SP | RH | RH_SP | DUT Temp |
|----|----------|------|------|---------|----|-------|----------|
| 2  | 06/05/05 | 0:00 | 20.7 | 25      | 0  | 0     | 20.6     |
| 3  | 06/05/05 | 0:01 | 20.8 | 25      | 0  | 0     | 20.6     |
| 4  | 06/05/05 | 0:02 | 20.9 | 25      | 0  | 0     | 20.6     |
| 5  | 06/05/05 | 0:03 | 20.8 | 25      | 0  | 0     | 20.6     |
| 6  | 06/05/05 | 0:04 | 20.9 | 25      | 0  | 0     | 20.6     |
| 7  | 06/05/05 | 0:05 | 21   | 25      | 0  | 0     | 20.6     |
| 8  | 06/05/05 | 0:06 | 21   | 25      | 0  | 0     | 20.6     |
| 9  | 06/05/05 | 0:07 | 21.2 | 25      | 0  | 0     | 20.6     |
| 10 | 06/05/05 | 0:08 | 21.2 | 25      | 0  | 0     | 20.6     |
| 11 | 06/05/05 | 0:09 | 21.2 | 25      | 0  | 0     | 20.7     |
| 12 | 06/05/05 | 0:10 | 21.2 | 25      | 0  | 0     | 20.6     |
| 13 | 06/05/05 | 0:11 | 21.3 | 25      | 0  | 0     | 20.7     |
| 14 | 06/05/05 | 0:12 | 21.4 | 25      | 0  | 0     | 20.8     |
| 15 | 06/05/05 | 0:13 | 21.5 | 25      | 0  | 0     | 20.8     |
| 16 | 06/05/05 | 0:14 | 21.5 | 25      | 0  | 0     | 20.8     |
| 17 | 06/05/05 | 0:15 | 21.5 | 25      | 0  | 0     | 20.9     |
| 18 | 06/05/05 | 0:16 | 21.5 | 25      | 0  | 0     | 20.9     |
| 19 | 06/05/05 | 0:17 | 21.5 | 25      | 0  | 0     | 20.9     |
| 20 | 06/05/05 | 0:18 | 21.2 | 25      | 0  | 0     | 20.8     |
| 21 | 06/05/05 | 0:19 | 20.9 | 25      | 0  | 0     | 20.7     |
| 22 | 06/05/05 | 0:20 | 20.9 | 25      | 0  | 0     | 20.6     |
| 23 | 06/05/05 | 0:21 | 20.7 | 25      | 0  | 0     | 20.6     |
| 24 | 06/05/05 | 0:22 | 20.6 | 25      | 0  | 0     | 20.5     |
| 25 | 06/05/05 | 0:23 | 20.6 | 25      | 0  | 0     | 20.5     |
| 26 | 06/05/05 | 0:24 | 20.6 | 25      | 0  | 0     | 20.5     |
| 27 | 06/05/05 | 0:25 | 20.6 | 25      | 0  | 0     | 20.4     |
| 28 | 06/05/05 | 0:26 | 20.6 | 25      | 0  | 0     | 20.4     |
| 29 | 06/05/05 | 0:27 | 20.6 | 25      | 0  | 0     | 20.5     |
| 30 | 06/05/05 | 0:28 | 20.7 | 25      | 0  | 0     | 20.5     |
| 31 | 06/05/05 | 0:29 | 20.8 | 25      | 0  | 0     | 20.6     |
| 32 | 06/05/05 | 0:30 | 20.9 | 25      | 0  | 0     | 20.6     |
| 33 | 06/05/05 | 0:31 | 20.9 | 25      | 0  | 0     | 20.6     |
| 34 | 06/05/05 | 0:32 | 21   | 25      | 0  | 0     | 20.6     |

Once opened, the log file will display columns of data including the date, time and corresponding process variable and setpoint values. The data can then be manipulated and graphed if desired using your spreadsheet program.

## 9. Communications

This section provides information on the communication protocol used to communicate to the EZT-550 over a serial connection.

**CAUTION** Special technical knowledge regarding serial communications is required to utilize the provided information. Attempted use without understanding all aspects of serial communications and connections may cause the EZT-550 to perform unexpected operation, resulting in disorder of the control system, damage, or accidents.

### 9.1 Connecting a Computer to the EZT-550

#### 9.1.1 RS-232 Serial Connection

To connect the chamber to a computer's serial port, a null-modem cable is required. This type of cable is designed to allow two computers to communicate with each other via their serial ports. This cable differs from that of a standard cable in the fact that the transmit and receive wires are reversed. If one is not available, a cable can be fashioned rather easily. Use a high quality shielded cable and connect the leads as shown below:

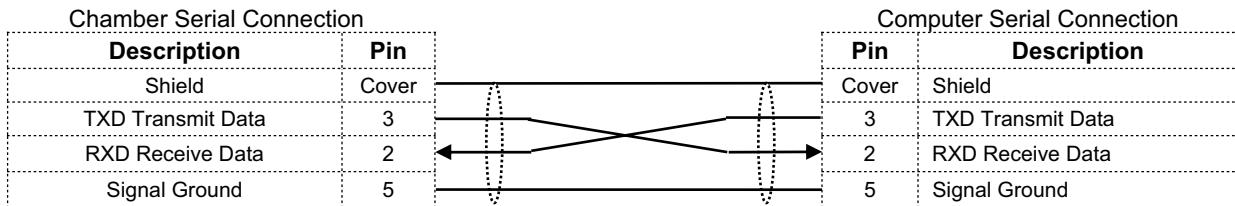

Connect the cable between the chambers serial port and the desired serial port on the computer. The serial port settings of the chamber's serial port are fixed. The computer's serial port must be set to match the chamber's port settings.

#### Chamber's Port Settings

Baud Rate: 9600  
 Data Bits: 7  
 Stop Bits: 2  
 Parity: Even

Device Address: 0

## 9.2 Maintenance Protocol

The computer and the EZT-550 CPU module communicate data by sending and receiving communications messages, which consist of request messages and reply messages. The request message is sent from the computer to write data to, read or clear data from the EZT-550U. The reply message is sent from the EZT-550 in response to the request message from the computer.

Communications is always initiated by the computer by sending a request message to the EZT-550 which then returns a reply message to the computer. The EZT-550 cannot initiate communications in the computer link system.

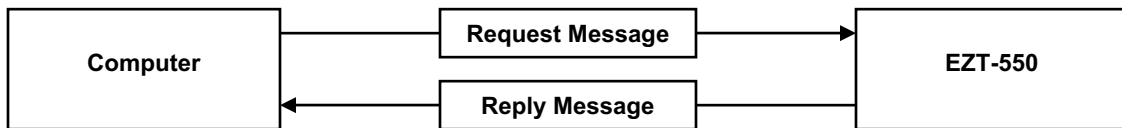

### Message Format

| Communication Message | BCC (Block Check Character) Calculation Range |                                        |                                                                                                  |                                                                                                                                                                                   |                                  |
|-----------------------|-----------------------------------------------|----------------------------------------|--------------------------------------------------------------------------------------------------|-----------------------------------------------------------------------------------------------------------------------------------------------------------------------------------|----------------------------------|
|                       | (1)                                           | (2)                                    | (3)                                                                                              |                                                                                                                                                                                   | (4) (5)                          |
| (1)                   | Communication control character (1 byte)      | Message start character                | ENQ (05h)<br>ACK (06h)<br>NAK (15h)                                                              | Enquiry<br>Acknowledge<br>Negative acknowledge                                                                                                                                    | Request message<br>Reply message |
| (2)                   | Communication device number (2 bytes)         | Device number to send request to       | 00 (0) through 1F (31)                                                                           | Designates a PLC device number to which the computer sends a request message in the 1:N communication computer link system.                                                       |                                  |
|                       |                                               | Device number to send reply from       | 00 (0) through 1F (31)                                                                           | Used in the 1:1 communication computer link system. PLC of any device number receives request message.<br>Indicates the device number of the PLC which returns the reply message. |                                  |
| (3)                   | Data (variable length)                        | Communication command, data type, etc. | Depends on each command.<br>See "Request Messages" on page 3.<br>See "Reply Messages" on page 5. |                                                                                                                                                                                   |                                  |
| (4)                   | BCC (2 bytes)                                 | Block check character                  | Exclusive OR (XOR) of the BCC calculation range.                                                 |                                                                                                                                                                                   |                                  |
| (5)                   | Terminator (1 byte)                           | Message end code                       | CR (0Dh)                                                                                         | Default                                                                                                                                                                           |                                  |

### 9.2.1 Write Data Command

Data can be written to multiple operands at a time starting with the specified operand in the EZT-550. This command can be used to turn the chamber on and off as well as set setpoints and start/stop a profile.

#### Request Message (Write Data Command)

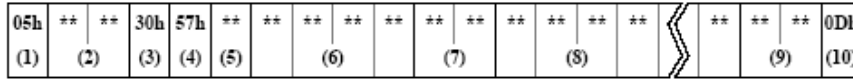

|      |                                        |                         |                                        |                                                               |
|------|----------------------------------------|-------------------------|----------------------------------------|---------------------------------------------------------------|
| (1)  | <b>Communication control character</b> | 1 byte                  | ENQ (05h)                              | Enquiry                                                       |
| (2)  | <b>Communication device number</b>     | 2 bytes                 | 00 - 1F<br>FF                          | Device number 0 through 31<br>Device number 255 (all devices) |
| (3)  | <b>Continuation</b>                    | 1 byte                  | 0 (30h)                                | Discontinued                                                  |
| (4)  | <b>Command</b>                         | 1 byte                  | W (57h)                                | Write data                                                    |
| (5)  | <b>Data type</b>                       | 1 byte                  | See table below.                       | N-byte designation                                            |
| (6)  | <b>Operand number</b>                  | 4 bytes                 | See table below.                       | First operand number to write to                              |
| (7)  | <b>Data length (n)</b>                 | 2 bytes                 | 00 - C8                                | Byte count of data to write<br>200 (C8h) bytes maximum        |
| (8)  | <b>Data</b>                            | 2n bytes<br>1 ≤ n ≤ 200 | 0 (30h) - 9 (39h)<br>A (41h) - F (46h) | Data to write                                                 |
| (9)  | <b>BCC</b>                             | 2 bytes                 | 00 - 7F                                | Block check character                                         |
| (10) | <b>Terminator</b>                      | 1 byte                  | CR (0Dh)                               | Message end code                                              |

**NOTES:**

- (2) Communication device number is always 00 (30h 30h).
- (5) Data type designation is D (44h).
- (6) See Section 9.3 for operand designations.
- (8) Data length varies upon number of operands written. Each operand consists of 2 bytes.
- (9) See Section 9.2.3 for BCC calculation.

#### Data Format in the Request Message (Write Data Command)

In order to properly insert the required fields into the request message, the values must be properly converted into ASCII codes. In the following example, a decimal data value of 40966 is to be written to an operand in the EZT-550.

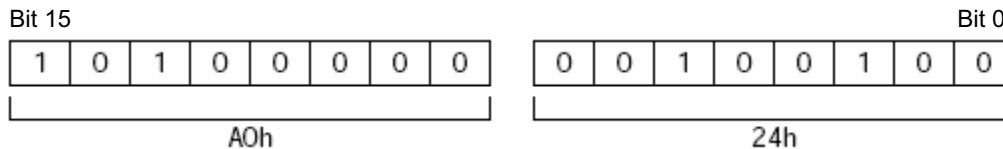

The value consists of two bytes, upper and lower. First, convert the decimal value into hexadecimal and then convert the hexadecimal value into ASCII codes. Upon conversion A024 will result in 4 bytes of data (41h 30h 32h 34h) in the request message. Consequently, the data length to write in this example is 16bits, or 2 (02h) bytes, so include ASCII codes 30h 32h in the request message for the data length.



**Reply Messages (Write Data Command)**

**OK Reply**

|     |     |     |     |     |    |     |
|-----|-----|-----|-----|-----|----|-----|
| 06h | **  | **  | 30h | **  | ** | 0Dh |
| (1) | (2) | (3) | (4) | (5) |    |     |

|     |                                        |         |           |                            |
|-----|----------------------------------------|---------|-----------|----------------------------|
| (1) | <b>Communication control character</b> | 1 byte  | ACK (06h) | Acknowledge                |
| (2) | <b>Communication device number</b>     | 2 bytes | 00 - 1F   | Device number 0 through 31 |
| (3) | <b>Command</b>                         | 1 byte  | 0 (30h)   | OK: Discontinued           |
| (4) | <b>BCC</b>                             | 2 bytes | 00 - 7F   | Block check character      |
| (5) | <b>Terminator</b>                      | 1 byte  | CR (0Dh)  | Message end code           |

**NG Reply**

|     |     |     |     |     |     |    |    |     |
|-----|-----|-----|-----|-----|-----|----|----|-----|
| 06h | **  | **  | 32h | 30h | 3+h | ** | ** | 0Dh |
| (1) | (2) | (3) | (4) | (5) | (6) |    |    |     |

|     |                                        |         |                                              |                                                                                          |
|-----|----------------------------------------|---------|----------------------------------------------|------------------------------------------------------------------------------------------|
| (1) | <b>Communication control character</b> | 1 byte  | ACK (06h)                                    | Acknowledge                                                                              |
| (2) | <b>Communication device number</b>     | 2 bytes | 00 - 1F                                      | Device number 0 through 31                                                               |
| (3) | <b>Command</b>                         | 1 byte  | 2 (32h)                                      | NG                                                                                       |
| (4) | <b>NG code</b>                         | 2 bytes | 06 (30h 36h)<br>07 (30h 37h)<br>08 (30h 38h) | Data range error<br>Timer/counter preset value change error<br>Calendar/clock data error |
| (5) | <b>BCC</b>                             | 2 bytes | 00 - 7F                                      | Block check character                                                                    |
| (6) | <b>Terminator</b>                      | 1 byte  | CR (0Dh)                                     | Message end code                                                                         |

If the request message was valid, the EZT-550 will send an OK reply to acknowledge the data write. If the message was formatted or received incorrectly, the EZT-550 will send an NG reply to notify the user that the command was not processed.

## 9.2.2 Read Data Command

Data can be read from multiple operands at a time starting with the specified operand in the EZT-550. This command can be used to read process variables, setpoints and chamber status.

### Request Message (Read Data Command)

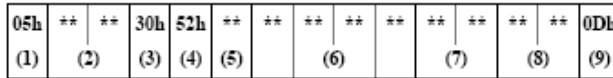

|     |                                 |         |                  |                                                               |
|-----|---------------------------------|---------|------------------|---------------------------------------------------------------|
| (1) | Communication control character | 1 byte  | ENQ (05h)        | Enquiry                                                       |
| (2) | Communication device number     | 2 bytes | 00 - 1F<br>FF    | Device number 0 through 31<br>Device number 255 (all devices) |
| (3) | Continuation                    | 1 byte  | 0 (30h)          | Discontinued                                                  |
| (4) | Command                         | 1 byte  | R (52h)          | Read data                                                     |
| (5) | Data type                       | 1 byte  | See table below. | N-byte designation                                            |
| (6) | Operand number                  | 4 bytes | See table below. | First operand number to read                                  |
| (7) | Data length (n)                 | 2 bytes | 00 - C8          | Byte count of data to read<br>200 (C8h) bytes maximum         |
| (8) | BCC                             | 2 bytes | 00 - 7F          | Block check character                                         |
| (9) | Terminator                      | 1 byte  | CR (0Dh)         | Message end code                                              |

### NOTES:

- (2) Communication device number is always 00 (30h 30h).
- (5) Data type designation is D (44h).
- (6) See Section 9.3 for operand designations.
- (7) Data length varies upon number of operands read. Each operand consists of 2 bytes.
- (8) See Section 9.2.3 for BCC calculation.

### Reply Messages (Read Data Command)

#### OK Reply

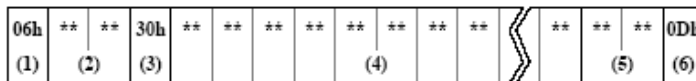

└──────────┘  
Data for 1-byte operand in ASCII format

|     |                                 |                         |                                        |                            |
|-----|---------------------------------|-------------------------|----------------------------------------|----------------------------|
| (1) | Communication control character | 1 byte                  | ACK (06h)                              | Acknowledge                |
| (2) | Communication device number     | 2 bytes                 | 00 - 1F                                | Device number 0 through 31 |
| (3) | Command                         | 1 byte                  | 0 (30h)                                | OK: Discontinued           |
| (4) | Data                            | 2n bytes<br>1 ≤ n ≤ 200 | 0 (30h) - 9 (39h)<br>A (41h) - F (46h) | Read data                  |
| (5) | BCC                             | 2 bytes                 | 00 - 7F                                | Block check character      |
| (6) | Terminator                      | 1 byte                  | CR (0Dh)                               | Message end code           |

**NG Reply**

|     |     |     |     |     |     |    |    |     |
|-----|-----|-----|-----|-----|-----|----|----|-----|
| 06h | **  | **  | 32h | 30h | 3+h | ** | ** | 0Dh |
| (1) | (2) | (3) | (4) | (5) | (6) |    |    |     |

|     |                                        |         |                              |                                               |
|-----|----------------------------------------|---------|------------------------------|-----------------------------------------------|
| (1) | <b>Communication control character</b> | 1 byte  | ACK (06h)                    | Acknowledge                                   |
| (2) | <b>Communication device number</b>     | 2 bytes | 00 - 1F                      | Device number 0 through 31                    |
| (3) | <b>Command</b>                         | 1 byte  | 2 (32h)                      | NG                                            |
| (4) | <b>NG code</b>                         | 2 bytes | 06 (30h 36h)<br>08 (30h 38h) | Data range error<br>Calendar/clock data error |
| (5) | <b>BCC</b>                             | 2 bytes | 00 - 7F                      | Block check character                         |
| (6) | <b>Terminator</b>                      | 1 byte  | CR (0Dh)                     | Message end code                              |

**Data Format in the Reply Message (Read Data Command)**

When reading data from the EZT-550, the values must be deciphered from the ASCII codes in order to get standard decimal values. In the following example, the read data from an operand in the EZT-50 is (30h 32h 43h 34h) which converted from ASCII codes to hexadecimal is 02C4.

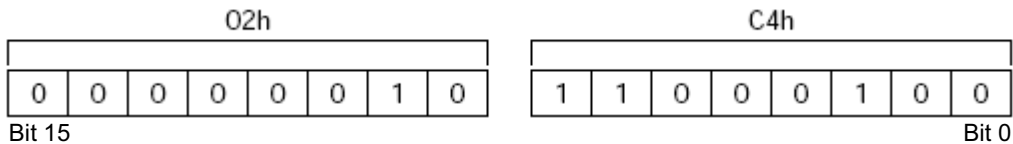

The hexadecimal value of 02C4 must then be converted to decimal in order to get the actual value of 708.

**9.2.3 BCC Block Check Calculation**

For both the write and read commands, the BCC must be calculated and inserted into the command. The BCC is used by the EZT-550 to make sure that the command sent was the command received. It does this by calculating the BCC of the received command and comparing it to the BCC sent in the command to verify that the received data is correct and has not been corrupted due to external noises or other causes. This calculation must also be done by the computer in order to verify that the reply message is accurate.

The following example shows how to calculate the BCC by XOR summation of each byte in the message.

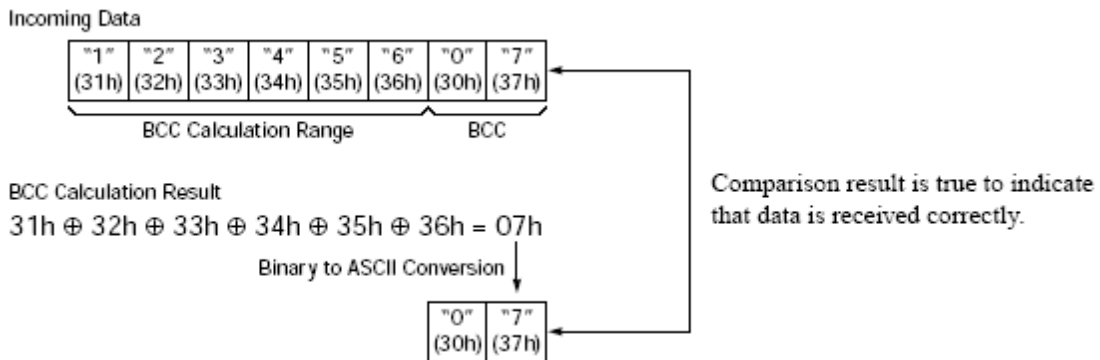

### 9.3 EZT-550 Operands

**CAUTION** Adhere to the following table of operands and their allowable data ranges. Do not exceed the ranges or attempt to write to any other operand number than those listed below. Failure to do so can result in controller failure and or damage to equipment.

| <b>Operand #</b> | <b>Description</b>                                                                                          | <b>Data Range</b>                                                                                                                                                                                                                                                                                                                                                                                                                                                              |
|------------------|-------------------------------------------------------------------------------------------------------------|--------------------------------------------------------------------------------------------------------------------------------------------------------------------------------------------------------------------------------------------------------------------------------------------------------------------------------------------------------------------------------------------------------------------------------------------------------------------------------|
| 0000             | <u>Alarm Acknowledge/Silence</u><br>Used to acknowledge a chamber alarm remotely and silence audible alarm. | <u>Write Only</u><br>2 = Acknowledge                                                                                                                                                                                                                                                                                                                                                                                                                                           |
| 0002             | <u>Chamber Events</u><br>Used to turn chamber systems on and off.                                           | <u>Read/Write (set bit on to turn on event)</u><br>Bit 0 = Chamber On/off<br>Bit 1 = Humidity System On/off<br>Bit 2 = Auxiliary Cooling On/Off<br>Bit 3 = Dry Air Purge On/Off<br><br><b>Note:</b> When setting events, each bit must be set every time the operand is written to in order to keep the event on.<br><br>Example:<br>Turn on chamber and humidity system:<br>Set bits 0 & 1 = decimal 3<br><br>Turn off humidity system only:<br>Set bit 0 on only = decimal 1 |
| 0003             | <u>Customer Events</u><br>Used to turn optional customer event relays on and off.                           | <u>Read/Write (set bit on to turn on event)</u><br>Bit 0 = Customer Event 1<br>Bit 1 = Customer Event 2<br>Bit 2 = Customer Event 3<br>Bit 3 = Customer Event 4<br>Bit 4 = Customer Event 5<br>Bit 5 = Customer Event 6<br>Bit 6 = Customer Event 7<br>Bit 7 = Customer Event 8<br>Bit 8 = Customer Event 9<br>Bit 9 = Customer Event 10<br>Bit 10 = Customer Event 11<br>Bit 11 = Customer Event 12                                                                           |
| 0004             | <u>Air Temperature Setpoint</u><br>Used to set single setpoint temperature.                                 | <u>Read/Write</u><br>Range = 0 to 100% relative humidity<br><br><b>Note:</b> The setpoint must be in whole numbers. The decimal point is implied as the first digit in the data value.<br><br>Example:<br>Setpoint of 50.0% = 500 sent to operand                                                                                                                                                                                                                              |

| Operand # | Description                                                               | Data Range                                                                                                                                                                                                                                                                                                                                                                                                                                                                                                  |
|-----------|---------------------------------------------------------------------------|-------------------------------------------------------------------------------------------------------------------------------------------------------------------------------------------------------------------------------------------------------------------------------------------------------------------------------------------------------------------------------------------------------------------------------------------------------------------------------------------------------------|
| 0005      | <p><u>Humidity Setpoint</u><br/>Used to set single setpoint humidity.</p> | <p><u>Read/Write</u><br/>Limited to temperature range of chamber. Typically <math>-73^{\circ}\text{C}</math> (<math>-100^{\circ}\text{F}</math>) to <math>190^{\circ}\text{C}</math> (<math>374^{\circ}\text{F}</math>). See chamber manual to verify valid safe operating range.</p> <p><b>Note:</b> The setpoint must be in whole numbers. The decimal point is implied as the first digit in the data value.</p> <p>Example:<br/>Setpoint of <math>42.4^{\circ}\text{C}</math> = 424 sent to operand</p> |
| 0016      | <p><u>Air Temperature</u></p>                                             | <p><u>Read Only</u><br/>Range = range of chamber</p> <p><b>Note:</b> The process variable is read in whole numbers. The decimal point is implied as the first digit in the data value</p> <p>Example:<br/>Data value read of 997 = <math>99.7^{\circ}</math></p>                                                                                                                                                                                                                                            |
| 0017      | <p><u>DUT (Product) Temperature</u></p>                                   | <p><u>Read Only</u><br/>Range = range of chamber</p> <p><b>Note:</b> The process variable is read in whole numbers. The decimal point is implied as the first digit in the data value</p> <p>Example:<br/>Data value read of 250 = <math>25.0^{\circ}</math></p>                                                                                                                                                                                                                                            |
| 0018      | <p><u>Relative Humidity</u></p>                                           | <p><u>Read Only</u><br/>Range = 0 – 100%</p> <p><b>Note:</b> The process variable is read in whole numbers. The decimal point is implied as the first digit in the data value</p> <p>Example:<br/>Data value read of 500 = 50.0%</p>                                                                                                                                                                                                                                                                        |
| 0029      | <p><u>Loop 1 (temperature) Percentage of Output</u></p>                   | <p><u>Read Only</u><br/>Range = -100.0 to 100.0%</p> <p><b>Note:</b> The value is read in whole numbers. The decimal point is implied as the first digit in the data value</p> <p>Example:<br/>Data value read of 379 = 37.9%</p>                                                                                                                                                                                                                                                                           |

| Operand # | Description                                                                            | Data Range                                                                                                                                                                                                                                                                                                                                                                                                                           |
|-----------|----------------------------------------------------------------------------------------|--------------------------------------------------------------------------------------------------------------------------------------------------------------------------------------------------------------------------------------------------------------------------------------------------------------------------------------------------------------------------------------------------------------------------------------|
| 0031      | <u>Loop 2 (humidity) Percentage of Output</u>                                          | <p><u>Read Only</u><br/>Range = -100.0 to 100.0%</p> <p><b>Note:</b> The value is read in whole numbers. The decimal point is implied as the first digit in the data value</p> <p>Example:<br/>Data value read of 379 = 37.9%</p>                                                                                                                                                                                                    |
| 0054      | <u>Chamber Status</u><br>Indicates chamber trouble.                                    | <p><u>Read Only</u><br/>1 = Product safety tripped<br/>8 = Chamber high limit tripped<br/>16 = Redundant product safety tripped (when optional limit installed)</p>                                                                                                                                                                                                                                                                  |
| 0055      | <u>Refrigeration System 1 Status</u><br>Indicates compressor trouble.                  | <p><u>Read Only</u><br/>1 = Pressure switch safety tripped<br/>4 = Discharge temperature thermostat tripped</p>                                                                                                                                                                                                                                                                                                                      |
| 0056      | <u>Refrigeration System 2 Status</u><br>Indicates compressor trouble.                  | <p><u>Read Only</u><br/>1 = Pressure switch safety tripped<br/>4 = Discharge temperature thermostat tripped</p>                                                                                                                                                                                                                                                                                                                      |
| 0057      | <u>Humidity System Status</u><br>Indicates humidity system trouble.                    | <p><u>Read Only</u><br/>Bit 0 = Humidity system disable (air temperature out of range)<br/>Bit 1 = Boiler over temperature<br/>Bit 3 = Boiler water level low<br/>Bit 4 = Reservoir level low (when optional reservoir installed)</p> <p><b>Note:</b> The alerts are bit oriented in the operand. The actual value of the operand is dependent upon the requests set.</p>                                                            |
| 0059      | <u>Maintenance Interval Alert</u><br>Indicates when a particular system needs service. | <p><u>Read Only</u><br/>Bit 0 = Air circulator service request<br/>Bit 1 = Refrigeration system service request<br/>Bit 3 = Heater service request<br/>Bit 4 = Humidity system service request<br/>Bit 5 = Dry air purge system request<br/>Bit 6 = Auxiliary cooling system service request</p> <p><b>Note:</b> The alerts are bit oriented in the operand. The actual value of the operand is dependent upon the requests set.</p> |

| Operand # | Description                                                                                                                                                                     | Data Range                                                                                                                                                                                                                                                                                                                                                                                                                                                                    |
|-----------|---------------------------------------------------------------------------------------------------------------------------------------------------------------------------------|-------------------------------------------------------------------------------------------------------------------------------------------------------------------------------------------------------------------------------------------------------------------------------------------------------------------------------------------------------------------------------------------------------------------------------------------------------------------------------|
| 0140      | <p><u>Cascade Control</u><br/>When cascade control is enabled, the DUT sensor will be used to control the heat/cool loop in order to get the product to temperature faster.</p> | <p><u>Read/Write</u><br/>0 = cascade control off<br/>1 = cascade control on</p>                                                                                                                                                                                                                                                                                                                                                                                               |
| 0143      | <p><u>Product High Limit</u><br/>Sets high alarm point for DUT protection.</p>                                                                                                  | <p><u>Read/Write</u><br/>Typically limited to <math>-80^{\circ}\text{C}</math> (<math>-112^{\circ}\text{F}</math>) to <math>200^{\circ}\text{C}</math> (<math>392^{\circ}\text{F}</math>). See chamber manual to verify valid safe operating range.</p> <p><b>Note:</b> The setpoint must be in whole numbers. The decimal point is implied as the first digit in the data value.</p> <p>Example:<br/>Setpoint of <math>42.4^{\circ}\text{C}</math> = 424 sent to operand</p> |
| 0144      | <p><u>Product Low Limit</u><br/>Sets low alarm point for DUT protection.</p>                                                                                                    | <p><u>Read/Write</u><br/>Typically limited to <math>-80^{\circ}\text{C}</math> (<math>-112^{\circ}\text{F}</math>) to <math>200^{\circ}\text{C}</math> (<math>392^{\circ}\text{F}</math>). See chamber manual to verify valid safe operating range.</p> <p><b>Note:</b> The setpoint must be in whole numbers. The decimal point is implied as the first digit in the data value.</p> <p>Example:<br/>Setpoint of <math>42.4^{\circ}\text{C}</math> = 424 sent to operand</p> |

### 9.3.1 Profile Area Operands

**CAUTION** When loading and controlling profiles over the communication link, the EZT-550 display will not correctly identify the loaded profile. The EZT-550 user interface will display the profile selected from its memory. Care should be taken to not confuse the two.

Profiles must be loaded into a specific memory area of the EZT-550. The memory area is formatted in a specific manner and the profile data must be loaded accordingly. Each profile consists of a 9 operand base area and consecutive 9 operand step areas.

Profile Base Operand Area

| <b>Operand #</b> | <b>Description</b>                                                                                                                               | <b>Data Range</b>                                                                                                                                                                                                                     |
|------------------|--------------------------------------------------------------------------------------------------------------------------------------------------|---------------------------------------------------------------------------------------------------------------------------------------------------------------------------------------------------------------------------------------|
| 3000             | <u>Total Number of Steps</u><br>This operand must be set to the total number of steps that will be downloaded for the profile.                   | <u>Read/Write</u><br>Range = 0 to 99 steps                                                                                                                                                                                            |
| 3001             | <u>Temperature Guaranteed Soak Band</u><br>This operand must be set for the deviation band temperature desired if guaranteed soak is being used. | <u>Read/Write</u><br>Range = temperature range<br><br><b>Note:</b> The setpoint must be in whole numbers. The decimal point is implied as the first digit in the data value.<br><br>Example:<br>Setpoint of 0.5°C = 5 sent to operand |
| 3002             | <u>Humidity Guaranteed Soak Band</u><br>This operand must be set for the deviation band humidity desired if guaranteed soak is being used.       | <u>Read/Write</u><br>Range = humidity range<br><br><b>Note:</b> The setpoint must be in whole numbers. The decimal point is implied as the first digit in the data value.<br><br>Example:<br>Setpoint of 3.0% = 30 sent to operand    |
| 3003-3008        | <u>Not Used on ZP(H) Series</u>                                                                                                                  | <u>Not Used on ZP(H) Series</u>                                                                                                                                                                                                       |

After loading the base operand area, the steps of the profile can be loaded. Each step is equivalent in order of data through its operands. This allows the profile to be downloaded quickly by using a single write command to write all of the operands for each step one after another by simply incremented the starting operand.



Profile Step Operand Area

The profile step area begins at operand 3009 and continues through operand 3899. The step data and operand configuration is shown in the table below using step 1 as the example. The arrangement is typical for each step. The operand for each consecutive step is 9 greater than the previous step. For example, step 1 begins at operand 3009 as shown in the table below. Step 2 begins at operand 3018, step 3 at operand 3027, etc.

| <b>Operand #</b> | <b>Description</b>                                                                                                       | <b>Data Range</b>                                                                                                                                                                                                                                                                                                                                                                                    |
|------------------|--------------------------------------------------------------------------------------------------------------------------|------------------------------------------------------------------------------------------------------------------------------------------------------------------------------------------------------------------------------------------------------------------------------------------------------------------------------------------------------------------------------------------------------|
| 3009             | <u>Step Time in Hours</u><br>This operand sets the time duration of the step in hours.                                   | <u>Read/Write</u><br>Range = 0 to 99 hours                                                                                                                                                                                                                                                                                                                                                           |
| 3010             | <u>Step Time in Minutes</u><br>This operand sets the time duration of the step in minutes.                               | <u>Read/Write</u><br>Range = 0 to 59 minutes                                                                                                                                                                                                                                                                                                                                                         |
| 3011             | <u>Chamber Events</u><br>This operand is used to turn the chamber systems on/off as required in the step of the profile. | <u>Read/Write (set bit on to turn on event)</u><br>Bit 0 = Chamber On/off<br>Bit 1 = Humidity System On/off<br>Bit 2 = Auxiliary Cooling On/Off<br>Bit 3 = Dry Air Purge On/Off                                                                                                                                                                                                                      |
| 3012             | <u>Customer Events</u><br>Used to turn optional customer event relays on and off as required in the step of the profile. | <u>Read/Write (set bit on to turn on event)</u><br>Bit 0 = Customer Event 1<br>Bit 1 = Customer Event 2<br>Bit 2 = Customer Event 3<br>Bit 3 = Customer Event 4<br>Bit 4 = Customer Event 5<br>Bit 5 = Customer Event 6<br>Bit 6 = Customer Event 7<br>Bit 7 = Customer Event 8<br>Bit 8 = Customer Event 9<br>Bit 9 = Customer Event 10<br>Bit 10 = Customer Event 11<br>Bit 11 = Customer Event 12 |
| 3013             | <u>Recycles</u><br>Sets the number of jumps to be performed at the end of the step.                                      | <u>Read/Write</u><br>Range = 0 to 99 jumps                                                                                                                                                                                                                                                                                                                                                           |
| 3014             | <u>Recycle Step</u><br>Specifies the step number to jump to when the step is complete.                                   | <u>Read/Write</u><br>Range = 0 to total number of steps in profile<br><br><b>Note:</b> To disable the jump, set operand to 0.                                                                                                                                                                                                                                                                        |

| <b>Operand #</b> | <b>Description</b>                                                                                                                                                                                                                                                                                                | <b>Data Range</b>                                                                                                                                                                                                                                                                                                                                                    |
|------------------|-------------------------------------------------------------------------------------------------------------------------------------------------------------------------------------------------------------------------------------------------------------------------------------------------------------------|----------------------------------------------------------------------------------------------------------------------------------------------------------------------------------------------------------------------------------------------------------------------------------------------------------------------------------------------------------------------|
| 3015             | <p><u>Air Temperature Setpoint</u><br/>Used to set the setpoint for air temperature during the step.</p> <p><b>Note:</b> If the setpoint of the previous step is different, the setpoint will ramp linearly from the previous step's setpoint to the current step's setpoint over the time length of the step</p> | <p><u>Read/Write</u><br/>Range = 0 to 100% relative humidity</p> <p><b>Note:</b> The setpoint must be in whole numbers. The decimal point is implied as the first digit in the data value.</p> <p>Example:<br/>Setpoint of 50.0% = 500 sent to operand</p>                                                                                                           |
| 3016             | <p><u>Humidity Setpoint</u><br/>Used to set the setpoint for humidity during the step.</p> <p><b>Note:</b> If the setpoint of the previous step is different, the setpoint will ramp linearly from the previous step's setpoint to the current step's setpoint over the time length of the step.</p>              | <p><u>Read/Write</u><br/>Limited to temperature range of chamber. Typically -73°C (-100°F) to 190°C (374°F). See chamber manual to verify valid safe operating range.</p> <p><b>Note:</b> The setpoint must be in whole numbers. The decimal point is implied as the first digit in the data value.</p> <p>Example:<br/>Setpoint of 42.4°C = 424 sent to operand</p> |
| 3017             | <u>Not Used on ZP(H) Series</u>                                                                                                                                                                                                                                                                                   | <u>Not Used on ZP(H) Series</u>                                                                                                                                                                                                                                                                                                                                      |

Once all of the steps are loaded. The profile can then be started and monitored using the operands from the following table.

Profile Control and Monitor Operands

| <b>Operand #</b> | <b>Description</b>                                                                                                           | <b>Data Range</b>                                                                                                                                                            |
|------------------|------------------------------------------------------------------------------------------------------------------------------|------------------------------------------------------------------------------------------------------------------------------------------------------------------------------|
| 0001             | <p><u>Profile Operating Status</u><br/>Used to start/stop and monitor profile operation.</p>                                 | <p><u>Read/Write</u><br/>0 = Stop Profile<br/>1 = Start Profile<br/>2 = Hold Profile</p> <p><u>Read Only</u><br/>4 = In Ramp<br/>8 = In Soak<br/>16 = In Guaranteed Soak</p> |
| 0041             | <p><u>Profile Start Step</u><br/>Selects the start step of the profile.</p>                                                  | <p><u>Read/Write</u><br/>Range is limited to last step of loaded profile.</p>                                                                                                |
| 0043             | <p><u>Hours Left in Current Step</u><br/>Contains the number of hours left in the step of the profile currently running.</p> | <p><u>Read Only</u><br/>Range is 0 to 99 hours.</p>                                                                                                                          |

| <b>Operand #</b> | <b>Description</b>                                                                                                       | <b>Data Range</b>                                                                                                   |
|------------------|--------------------------------------------------------------------------------------------------------------------------|---------------------------------------------------------------------------------------------------------------------|
| 0044             | <u>Minutes Left in Current Step</u><br>Contains the number of minutes left in the step of the profile currently running. | <u>Read Only</u><br>Range is 0 to 59 minutes.                                                                       |
| 0045             | <u>Hours Left in Current Profile</u><br>Contains the number of hours left in the profile currently running.              | <u>Read Only</u><br>Range is 0 to 32767 hours.                                                                      |
| 0046             | <u>Minutes Left in Current Profile</u><br>Contains the number of minutes left in the profile currently running.          | <u>Read Only</u><br>Range is 0 to 59 minutes.                                                                       |
| 0047             | <u>Total Run Hours of Current Profile</u><br>Contains the number of hours the current profile has run.                   | <u>Read Only</u><br>Range is 0 to 32767 hours.                                                                      |
| 0048             | <u>Total Run Minutes of Current Profile</u><br>Contains the number of minutes the current profile has run.               | <u>Read Only</u><br>Range is 0 to 59 minutes.                                                                       |
| 0049             | <u>Current Step in Profile</u><br>Contains current step profile is running.                                              | <u>Read Only</u><br>Range is limited to last step of loaded profile.                                                |
| 0051             | <u>Recycle Step</u><br>Displays the step number that will be jumped to at the completion of the current step.            | <u>Read Only</u><br>Range is limited to last step of loaded profile. (value of 0 indicates no jump step programmed) |
| 0052             | <u>Recycle Counts Left</u><br>Displays number of jumps remaining.                                                        | <u>Read Only</u><br>Range = 0 to 99                                                                                 |

---

## Appendix A

The passcode for System Maintenance is **40104**. It is recommended that this sheet be removed from the manual and stored in a safe location to prevent unauthorized personnel from accessing the maintenance area.

## Appendix B

**ASCII Character Code Table**

| Upper Bit<br>Lower Bit | 0   | 1   | 2  | 3  | 4  | 5  | 6   | 7   | 8   | 9   | A   | B   | C   | D   | E   | F   |
|------------------------|-----|-----|----|----|----|----|-----|-----|-----|-----|-----|-----|-----|-----|-----|-----|
| <b>0</b>               | NUL | DLE | SP | 0  | @  | P  | `   | p   |     |     |     |     |     |     |     |     |
| Decimal                | 0   | 16  | 32 | 48 | 64 | 80 | 96  | 112 | 128 | 144 | 160 | 176 | 192 | 208 | 224 | 240 |
| <b>1</b>               | SOH | DC1 | !  | 1  | A  | Q  | a   | q   |     |     |     |     |     |     |     |     |
| Decimal                | 1   | 17  | 33 | 49 | 65 | 81 | 97  | 113 | 129 | 145 | 161 | 177 | 193 | 209 | 225 | 241 |
| <b>2</b>               | STX | DC2 | "  | 2  | B  | R  | b   | r   |     |     |     |     |     |     |     |     |
| Decimal                | 2   | 18  | 34 | 50 | 66 | 82 | 98  | 114 | 130 | 146 | 162 | 178 | 194 | 210 | 226 | 242 |
| <b>3</b>               | ETX | DC3 | #  | 3  | C  | S  | c   | s   |     |     |     |     |     |     |     |     |
| Decimal                | 3   | 19  | 35 | 51 | 67 | 83 | 99  | 115 | 131 | 147 | 163 | 179 | 195 | 211 | 227 | 243 |
| <b>4</b>               | EOT | DC4 | \$ | 4  | D  | T  | d   | t   |     |     |     |     |     |     |     |     |
| Decimal                | 4   | 20  | 36 | 52 | 68 | 84 | 100 | 116 | 132 | 148 | 164 | 180 | 196 | 212 | 228 | 244 |
| <b>5</b>               | ENQ | NAK | %  | 5  | E  | U  | e   | u   |     |     |     |     |     |     |     |     |
| Decimal                | 5   | 21  | 37 | 53 | 69 | 85 | 101 | 117 | 133 | 149 | 165 | 181 | 197 | 213 | 229 | 245 |
| <b>6</b>               | ACK | SYN | &  | 6  | F  | V  | f   | v   |     |     |     |     |     |     |     |     |
| Decimal                | 6   | 22  | 38 | 54 | 70 | 86 | 102 | 118 | 134 | 150 | 166 | 182 | 198 | 214 | 230 | 246 |
| <b>7</b>               | BEL | ETB | '  | 7  | G  | W  | g   | w   |     |     |     |     |     |     |     |     |
| Decimal                | 7   | 23  | 39 | 55 | 71 | 87 | 103 | 119 | 135 | 151 | 167 | 183 | 199 | 215 | 231 | 247 |
| <b>8</b>               | BS  | CAN | (  | 8  | H  | X  | h   | x   |     |     |     |     |     |     |     |     |
| Decimal                | 8   | 24  | 40 | 56 | 72 | 88 | 104 | 120 | 136 | 152 | 168 | 184 | 200 | 216 | 232 | 248 |
| <b>9</b>               | HT  | EM  | )  | 9  | I  | Y  | i   | y   |     |     |     |     |     |     |     |     |
| Decimal                | 9   | 25  | 41 | 57 | 73 | 89 | 105 | 121 | 137 | 153 | 169 | 185 | 201 | 217 | 233 | 249 |
| <b>A</b>               | LF  | SUB | *  | :  | J  | Z  | j   | z   |     |     |     |     |     |     |     |     |
| Decimal                | 10  | 26  | 42 | 58 | 74 | 90 | 106 | 122 | 138 | 154 | 170 | 186 | 202 | 218 | 234 | 250 |
| <b>B</b>               | VT  | ESC | +  | ;  | K  | [  | k   | {   |     |     |     |     |     |     |     |     |
| Decimal                | 11  | 27  | 43 | 59 | 75 | 91 | 107 | 123 | 139 | 155 | 171 | 187 | 203 | 219 | 235 | 251 |
| <b>C</b>               | FF  | FS  | ,  | <  | L  | \  | l   |     |     |     |     |     |     |     |     |     |
| Decimal                | 12  | 28  | 44 | 60 | 76 | 92 | 108 | 124 | 140 | 156 | 172 | 188 | 204 | 220 | 236 | 252 |
| <b>D</b>               | CR  | GS  | -  | =  | M  | ]  | m   | }   |     |     |     |     |     |     |     |     |
| Decimal                | 13  | 29  | 45 | 61 | 77 | 93 | 109 | 125 | 141 | 157 | 173 | 189 | 205 | 221 | 237 | 253 |
| <b>E</b>               | SO  | RS  | .  | >  | N  | ^  | n   | ~   |     |     |     |     |     |     |     |     |
| Decimal                | 14  | 30  | 46 | 62 | 78 | 94 | 110 | 126 | 142 | 158 | 174 | 190 | 206 | 222 | 238 | 254 |
| <b>F</b>               | SI  | US  | /  | ?  | O  | _  | o   |     |     |     |     |     |     |     |     |     |
| Decimal                | 15  | 31  | 47 | 63 | 79 | 95 | 111 | 127 | 143 | 159 | 175 | 191 | 207 | 223 | 239 | 255 |