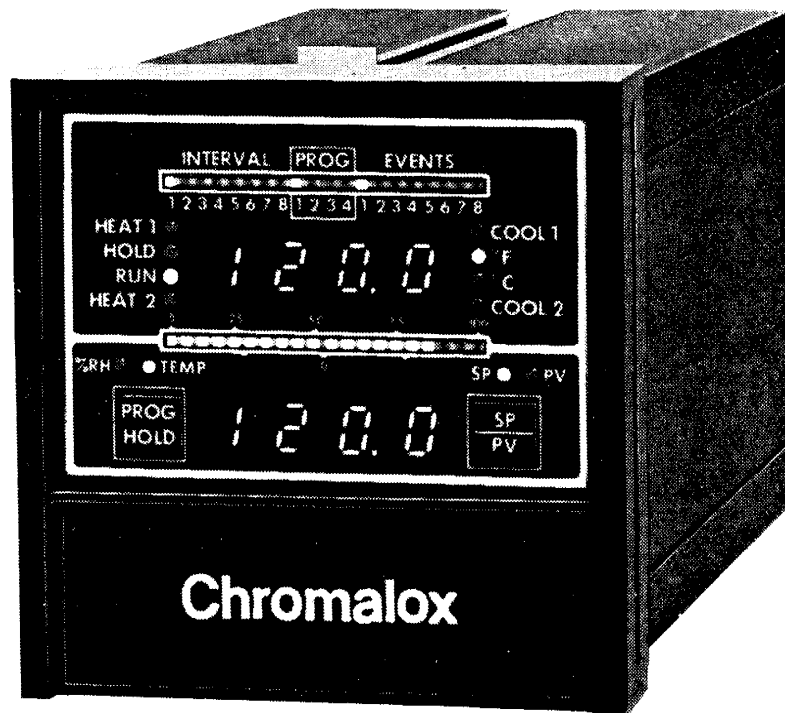


# 2030

# Chromalox<sup>®</sup>

## Microprocessor-based Environmental Test Chamber Controller



Issue Date  
May 1992

User's Manual  
0037-75106

# Table of Contents

---

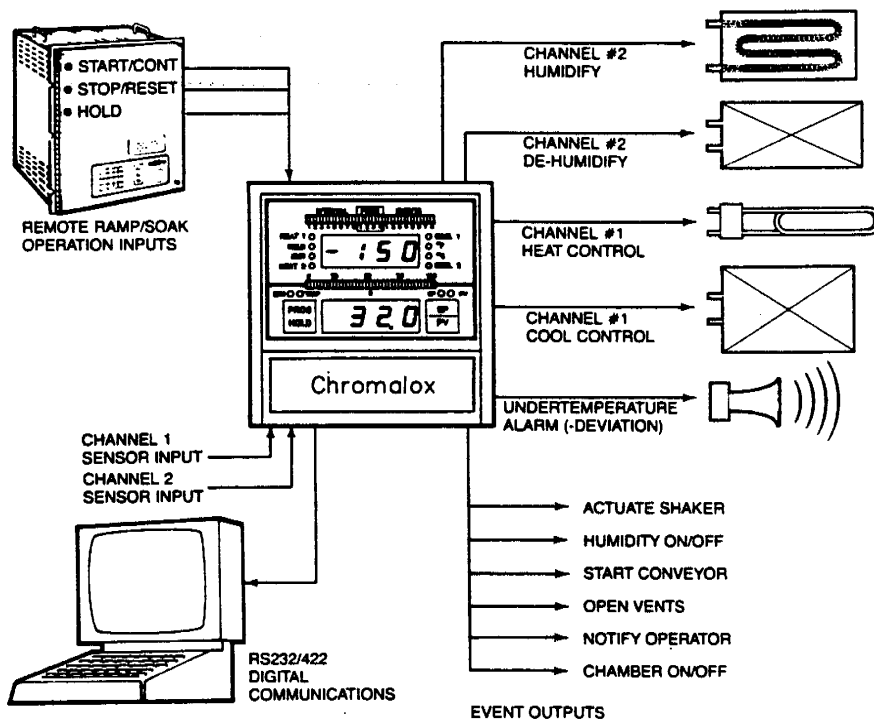
Section	Topic	Page
1	<b>General Information.</b> . . . . .	1
	Applications. . . . .	1
	Model Identification. . . . .	2
2	<b>Installation.</b> . . . . .	5
	Mounting. . . . .	5
	Important Wiring Information. . . . .	6
	Wiring—Sensor Inputs. . . . .	8
	Changing Inputs Cards. . . . .	11
	Wiring—Control Outputs. . . . .	12
	<b>Operation.</b> . . . . .	15
3	PAGE/MENU Programming. . . . .	15
	Security Levels. . . . .	17
	Pushbuttons and Indications. . . . .	18
	Programming Practice. . . . .	21
	Ramp/Soak Programming and Operation. . . . .	24
	Configuring a Ramp/Soak Program. . . . .	27
4	<b>PAGE/MENU Tables.</b> . . . . .	33
5	<b>Event and Alarm Outputs and Remote Ramp/Soak Operation Inputs.</b> . . . . .	45
	Wiring. . . . .	45
	Programming. . . . .	46
	Configuring Alarm Outputs as Events. . . . .	46
	Remote Ramp/Soak Operation Inputs. . . . .	47
	Remote Ramp/Soak Operation Inputs Wiring. . . . .	47
6	<b>Analog Process Output Option.</b> . . . . .	49
	Wiring. . . . .	50
	Programming. . . . .	51
7	<b>Digital Communications.</b> . . . . .	53
	Terminal Interface Mode. . . . .	53
	Wiring and Terminal Connections. . . . .	54
	Automatic Data Logging Mode. . . . .	56
8	<b>Calibration.</b> . . . . .	59
	Quick Step Calibration. . . . .	59
	Manual Calibration. . . . .	61
	Analog Output Calibration. . . . .	62
9	<b>Specifications.</b> . . . . .	65
10	<b>Error Codes and Troubleshooting.</b> . . . . .	69
<b>Appendices</b>		
I	<b>Control Theory Tutorial.</b> . . . . .	71
II	<b>PAGE/MENU Tables, Condensed.</b> . . . . .	89

# SECTION 1 GENERAL INFORMATION

## THE BIG PICTURE

The Chromalox 2030 Ramp/Soak Temperature and Process Controller is designed to handle the simplest single or dual channel control applications as well as sophisticated ramp/soak applications. To most effectively implement the controller in your application, it is important that you take time to see the "Big Picture" - the type of controller you have purchased, and how the programming and configuration is organized. This will make it even easier and quicker for you to get your controller up and running!

**Figure 1.1**  
Environmental Test Chamber  
Control Application



**Model Identification** is critical to efficient installation and programming. Following the Model Identification table below, you can identify the controller model that you have purchased. Your controller will have either one or two sensor input types, for example:

2030-22810 One sensor input, Type T thermocouple  
 2030-22844 Two sensor inputs, both 100 ohm Pt RTDs

or any combination of the 3 possible input types.

The special suffix -0001 at the end of the model number indicates that the RTD alpha = .00392, as opposed to the standard alpha = .00385.

# Table of Contents

---

Section	Topic	Page
1	<b>General Information.</b> . . . . .	1
	Applications. . . . .	1
	Model Identification. . . . .	2
2	<b>Installation.</b> . . . . .	5
	Mounting. . . . .	5
	Important Wiring Information. . . . .	6
	Wiring—Sensor Inputs. . . . .	8
	Changing Inputs Cards. . . . .	11
	Wiring—Control Outputs. . . . .	12
	<b>Operation.</b> . . . . .	15
3	PAGE/MENU Programming. . . . .	15
	Security Levels. . . . .	17
	Pushbuttons and Indications. . . . .	18
	Programming Practice. . . . .	21
	Ramp/Soak Programming and Operation. . . . .	24
	Configuring a Ramp/Soak Program. . . . .	27
4	<b>PAGE/MENU Tables.</b> . . . . .	33
5	<b>Event and Alarm Outputs and Remote Ramp/Soak Operation Inputs.</b> . . . . .	45
	Wiring. . . . .	45
	Programming. . . . .	46
	Configuring Alarm Outputs as Events. . . . .	46
	Remote Ramp/Soak Operation Inputs. . . . .	47
	Remote Ramp/Soak Operation Inputs Wiring. . . . .	47
6	<b>Analog Process Output Option.</b> . . . . .	49
	Wiring. . . . .	50
	Programming. . . . .	51
7	<b>Digital Communications.</b> . . . . .	53
	Terminal Interface Mode. . . . .	53
	Wiring and Terminal Connections. . . . .	54
	Automatic Data Logging Mode. . . . .	56
8	<b>Calibration.</b> . . . . .	59
	Quick Step Calibration. . . . .	59
	Manual Calibration. . . . .	61
	Analog Output Calibration. . . . .	62
9	<b>Specifications.</b> . . . . .	65
10	<b>Error Codes and Troubleshooting.</b> . . . . .	69
<b>Appendices</b>		
I	<b>Control Theory Tutorial.</b> . . . . .	71
II	<b>PAGE/MENU Tables, Condensed.</b> . . . . .	89

# List of Figures

---

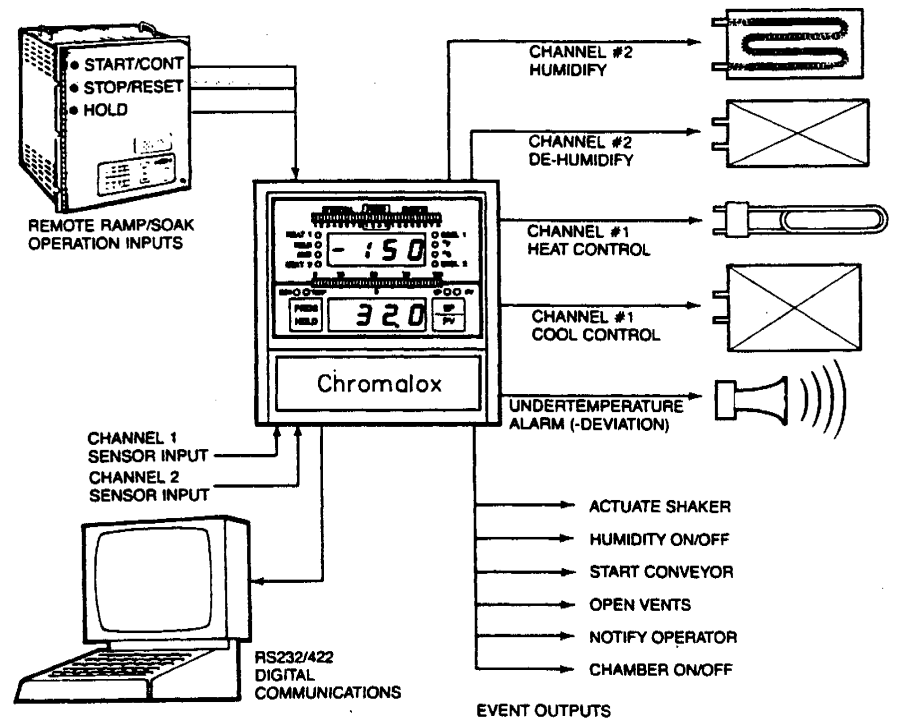
<b>Figure</b>	<b>Topic</b>	<b>Page</b>
1.1	Environmental Test Chamber Control Application. . . . .	1
1.2	Model Identification Table. . . . .	2
2.1	Removing the 2030 Chassis from Case. . . . .	5
2.2	Mounting Dimensions. . . . .	6
2.3	Mounting Diagram. . . . .	6
2.4	Wiring Terminal Identification. . . . .	8
2.5	Thermocouple Connections. . . . .	9
2.6	Three-Wire RTD Connections. . . . .	9
2.7	Locating Channel #1 and Channel #2 Input Cards. . . . .	10
2.8	Current/Voltage Input Card Jumper Positions. . . . .	10
2.9	Current/Voltage Input Connections. . . . .	10
2.10	Input Cards. . . . .	11
2.11	Input Card Standoff Screw. . . . .	11
2.12	Changing Input Cards. . . . .	11
2.13	Solid State Relay Output Connections. . . . .	12
2.14	Locating Output Modules. . . . .	13
2.15	4-20 mA/1-5 Vdc Jumper Positions. . . . .	13
2.16	4-20 mA/1-5 Vdc Output Connection. . . . .	13
3.1	PAGE/MENU Programming Concepts. . . . .	14
3.2	PAGE/MENU Contents. . . . .	16
3.3	PAGE/MENU Contents of Security Levels A-F. . . . .	17
3.4	Security Codes and View/Adjust Levels. . . . .	18
3.5	Front Panel Displays During Normal Operation. . . . .	18
3.6	Front Panel Displays and Pushbuttons. . . . .	19
3.7	Alphanumeric Command Cue "Standby" Set Point PAGE 1/MENU 1. . . . .	20
3.8	PAGE/MENU Number in Lower Digital Display. . . . .	21
3.9	Ramp/Soak Pushbutton Operation and LED Indication. . . . .	31
5.1	Event Outputs Applied in a Process. . . . .	45
5.2	Field Wiring for Event Outputs. . . . .	45
5.3	Field Wiring for Remote Ramp/Soak Operation Inputs. . . . .	48
6.1	Locating the Process Analog Output Circuit Card. . . . .	50
6.2	Jumper Positioning for Analog Process Output Signal Selection. . . . .	50
6.3	Field Wiring for Analog Process Output. . . . .	50
7.1	2030 Controller with Dumb Terminal Digital Communications Interface. . . . .	53
7.2	2030 Controller Terminal Designations. . . . .	54
7.3	Field Wiring for RS232 Digital Communications. . . . .	54
7.4	Field Wiring for RS422 Digital Communications. . . . .	54
7.5	Digital Communications Circuit Card. . . . .	55
7.6	RS422A Jumper Positions. . . . .	55
7.7	Standard Connector Pin Assignments. . . . .	56
7.8	Automatic Data Logging Sample Print Out. . . . .	56
8.1	QUICK STEP Calibration Procedure Codes. . . . .	60

# SECTION 1 GENERAL INFORMATION

## THE BIG PICTURE

The Chromalox 2030 Ramp/Soak Temperature and Process Controller is designed to handle the simplest single or dual channel control applications as well as sophisticated ramp/soak applications. To most effectively implement the controller in your application, it is important that you take time to see the "Big Picture" - the type of controller you have purchased, and how the programming and configuration is organized. This will make it even easier and quicker for you to get your controller up and running!

**Figure 1.1  
Environmental Test Chamber  
Control Application**



**Model Identification** is critical to efficient installation and programming. Following the Model Identification table below, you can identify the controller model that you have purchased. Your controller will have either one or two sensor input types, for example:

- 2030-22810 One sensor input, Type T thermocouple
- 2030-22844 Two sensor inputs, both 100 ohm Pt RTDs

or any combination of the 3 possible input types.

The special suffix -0001 at the end of the model number indicates that the RTD alpha = .00392, as opposed to the standard alpha = .00385.

**Figure 1.2**  
**Model Identification Table**

<b>2030</b>	<b>Ramp/Soak Controller with 16 Programs, 8 Intervals per Program, 4 Event/Alarm Outputs; Dual LED Display, Alphanumeric Cues, Analog Bar Graph LED; 2 Output Channels, Each Channel Assignable as Dual Output (Total 4 outputs), PID or ON/OFF Control, Direct or Reverse Acting Control Output.</b>		
	<b>Code</b>	<b>Channel #1 Outputs (Heat/Cool)</b>	
	2	Dual Solid State Relay (SSR) Outputs, 120/230 Vac	
		<b>Code</b>	<b>Channel #2 Outputs (Humidify/De-Humidify)</b>
		2	Dual Solid State Relay (SSR) Outputs, 120/230 Vac
		<b>Code</b>	<b>Auxiliary Analog and Digital Inputs/Outputs and Digital Comm. Options</b>
		0	None
		2	4-20 mA Process or Ramp Profile Analog Output, or 4-20 mA Control Output
		5	4 Additional Event/Alarm Outputs (for total 8), 3 Remote Ramp/Soak Inputs and Digital Communications RS232 or 422A
		8	All of the Above (Codes 2 + 5)
		<b>Code</b>	<b>Sensor Input</b>
		0	None
		1	Type T Thermocouple                    -150 to 500°F                    -101 to 260°C
		3	4-20 mA Current or 1-5 Vdc Voltage                    0.0 to 100.0%
		4	RTD, 100 ohm Platinum*                    -110.0 to 425.0°F                    -78.9 to 218.3°C
		<b>Code</b>	<b>Sensor Input</b>
		0	None
		1	Type T Thermocouple                    -150 to 500°F                    -101 to 260°C
		3	4-20 mA Current or 1-5 Vdc Volt.                    0.0 to 100.0%
		4	RTD, 100 ohm Platinum*                    -110.0 to 425.0°F                    -78.9 to 218.3°C

2030 - 2

2

8

4

4

**Typical Model Number**

\*Narrow range of 32.0 to 212.0°F selectable via programming.

\*\*Suffix -0001 (for example 2030-22844-0001) indicates RTD alpha = .00392.

**Model Identification Codes**

Throughout the manual you will find references to "codes." This refers to the code number in the model identification, which corresponds to a specific input types of your controller. For example, when wiring the input, "code 4" corresponds to RTD input.

**Two Control Output Channels**

Now that you have identified your controller model, you can easily see that the 2030 controller has two control output channels - each channel providing bimodal control - for a total of 4 control outputs. How each of the outputs is used (heat control, cool control, humidify control, de-humidify control), and PID or ON/OFF control mode is selected in the Menu Listed Programming, as are the control parameters for each of these outputs.

**Input Types**

The 4 different input codes each correspond to a specific input type. Code "3" applies to both the 4-20 mA and 1-5 Vdc analog outputs. The input be changed from 4-20 mA to 1-5 Vdc by a simple jumper move, as described in the Installation section.

## Auxiliary Analog and Digital Inputs/Outputs Programming Structure

Your 2030 controller may be equipped with up to 4 additional special options:

**Process or Control Analog Output** allows you to transmit any one of several process variables via a 4-20 mA/1-5Vdc field selectable signal. For example, this option could be applied to transmit the relative humidity measurement to a recorder or computer. This Analog Output can also be assigned to represent the actual control output signal of any one of the 4 control outputs.

**4 Additional Event Outputs**, giving you up to a total of 8 Event/Alarm Outputs.

**3 Remote Ramp/Soak Operation Inputs** give you the ability to START/CONTINUE, STOP/RESET and HOLD the Ramp/Soak Programs from a remotely located switching device.

**RS232 and RS 422A Digital Communications and Automatic Data Logging** require no external software or expensive hardware since the software is built-in to the 2030 controller. **Any parameter that can be selected or adjusted from the controller's front panel can likewise be handled with the digital communications interface.**

## Simple Programming

The Menu-Listed Programming is structured into groups of like adjustments, functions and parameters. These groups are called PAGES. There are a total of 22 PAGES of programming selections and adjustments. Each page contains a list of MENU numbers, and each MENU number represents an individual selection or adjustment. Every parameter has its own PAGE/MENU number "address" that you can go directly to, without stepping through a long list of unnecessary entries. Many of the parameters also have alphanumeric command cues, making it even easier to program the controller and make adjustments later.

## Security Levels

The 2030 PAGE/MENU programming structure is protected by 6 Security Levels, A-F. Each of the Security Levels allows **viewing** of certain PAGE/MENU numbers and **adjustment** of certain other PAGE/MENU numbers. The Security Level that you choose for the controller is field selected and may be changed at any time.

## IMPORTANT!

**Read this manual carefully and thoroughly before attempting installation and programming of the 2030 controller. Improper configuration and selection of parameter values could result in damage to equipment, the controller and possibly even personal injury. It is your responsibility to assure that the controller is safely installed and configured.**





## SECTION 2 INSTALLATION

---

### Inspection and Unpacking

On receipt of your 2030 controller, immediately make note of any visible damage to the shipment packaging and record this damage on the shipping documents. Unpack the controller and carefully inspect it for obvious damage due to shipment. If any damage has occurred, YOU must file a claim with the transporter, as they will not accept a claim from the shipper.

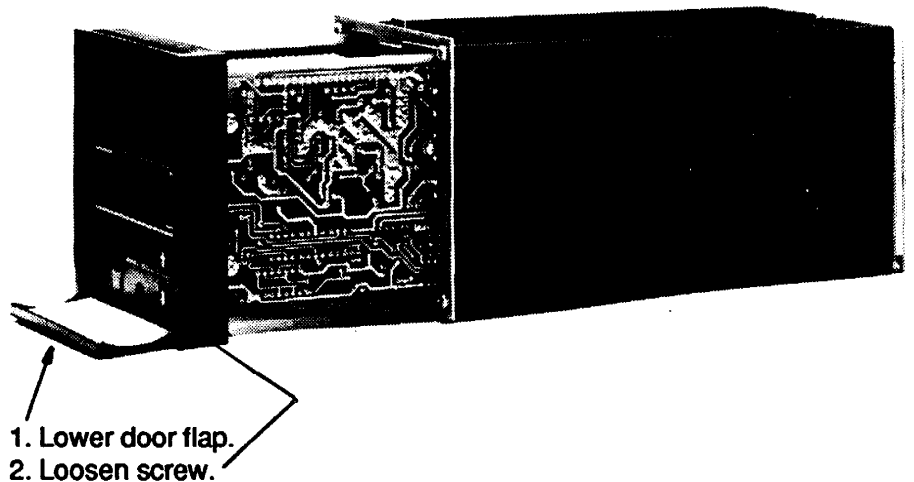
If the controller will not be immediately installed and placed into operation, it should be stored in a cool, dry environment in its original protective packaging until time for installation and operation. Temperature extremes and excessive moisture can damage the instrument.

### Removing the 2030 from Its Case

The 2030 instrument chassis can be easily removed from its case either before or after mounting and wiring. Some applications require internal jumper changes, making it necessary to remove the controller chassis from the case. If input cards are changed, it is also necessary to remove the controller from its case.

To remove the chassis, lower the front door flap and loosen the screw. Pull the chassis out from the case to expose the controller circuit cards. See Figure 2.1 below.

**Figure 2.1**  
**Removing the 2030 Chassis**  
**from Case**

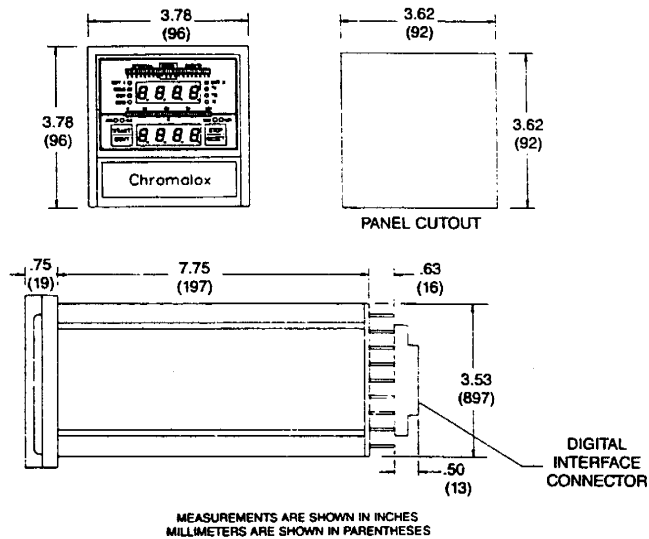


### MOUNTING

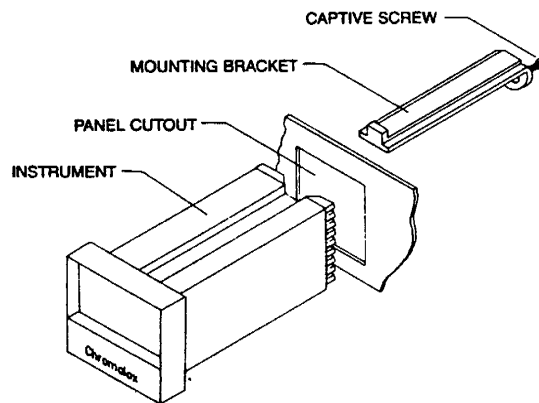
The 2030 controller should be mounted in a location free from excessive dust, oil accumulations and moisture. It may be mounted in any position at ambient temperatures of 30°F to 130°F (0°C to 55°C).

Figure 2.2 gives the mounting dimensions for the controller. Cut out the square mounting hole and install the unit in accordance with the mounting diagram Figure 2.3. Loosen the mounting brackets' captive screws at the rear of the controller, sliding the brackets off the controller, and placing the controller through the square panel cutout. Replace the mounting brackets and tighten the screws to secure the controller firmly against the mounting surface.

**Figure 2.2  
Mounting Dimensions**



**Figure 2.3  
Mounting Diagram**



XX

**IMPORTANT WIRING INFORMATION!**

XX

To insure that the Chromalox 2030 controller performs optimally, it is imperative that you read this section and become familiar with several wiring practices critical to eliminating electrical noise. Failure to follow these recommended wiring practices can result in poor temperature control and ineffective controller application.

**Snubbers**

Snubbers should be used to protect the controller from electrical noise generated by inductive loads such as motors, solenoids, coils and relays operating near the 2030. The snubber is a .1uf capacitor (600 Vdc rating) in series with a 100 ohm resistor. Snubbers are available from Chromalox (Part No. 0149-00012).

When using the Alarm Output or Triac Control Output to drive a contactor coil or other inductive load, the snubbers should be connected in parallel with the contactor coil. Install the snubbers as shown in the individual wiring diagrams.

## **Good Wiring Practice**

Read and follow these Good Wiring Practices when connecting this and any other controller:

1. Do not run sensor leadwires and power leads together in the same conduit or wire tray.
2. When planning the system wiring, be sure to consider the importance of separating wiring into functionally similar bundles - i.e. power leads, sensor leads, output signal lines, etc. If the power leads and sensor leads must cross, they should cross at a 90° angle to each other (perpendicular).
3. Locate all sources of noise in your system - motors, contacts, solenoids, etc. Then design your system such that wiring is separated as far as possible from these noise sources.
4. Shielded, twisted wire should be used for the control circuit signals if they are run in parallel with other control circuit signal wires, or if they are run distances greater than 2-3 feet.
5. To protect against noise, use shielded cables for all low power signal lines.
6. Additional information on good wiring practices is available from IEEE, 345 East 47th St., NY, NY 10017. Request IEEE Standard No. 518-1982.

## **WIRING**

Make all electrical wiring connections on the back of the controller **before** power is applied to the unit.

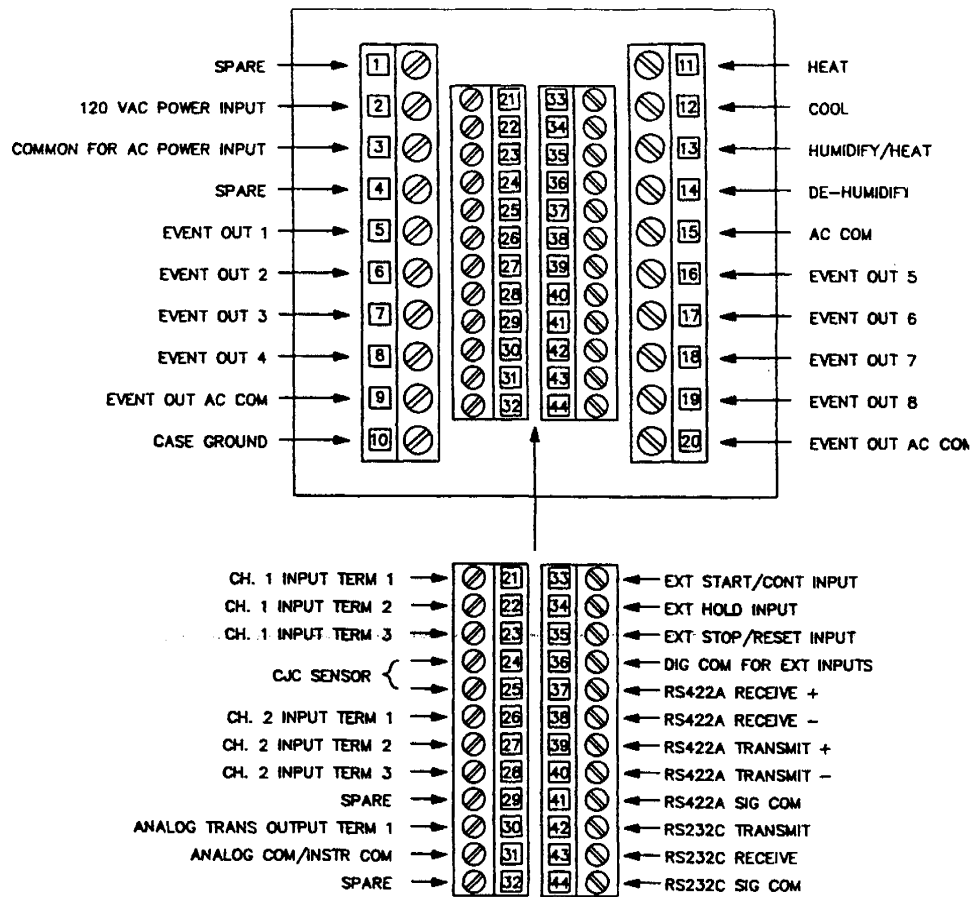
All wiring must comply with local codes, regulations and ordinances. This instrument is intended for panel mounting and the terminals must be enclosed within a panel. Use National Electric Code (NEC) Class 1 wiring for all terminals except the sensor terminals.

Check the wiring decal on the side of the unit to verify the model number. The wiring decal also shows wiring terminations. All wires will be connected to the terminals on the back of the case. Specific wiring instructions for different input and output types are given in this section.

Detailed wiring instructions for Digital Communications, Event Outputs, Remote Ramp/Soak Operation Inputs, and Analog Output options are given in separate sections covering each of these topics.

Using the proper size wire for rated circuits, make the wiring connections as shown in Figure 2.4. Detailed sensor input and control output wiring diagrams follow.

**Figure 2.4**  
Wiring Terminal  
Identification



**SENSOR INPUT  
WIRING**

The model 2030 controller is supplied with one or two types of input cards for each of the sensor inputs, as identified by the unit model number. The last two digits in the model number are the sensor input codes.

2030 - \*\*\* \_ \_

Code	Sensor Type
1	Type T Thermocouple
3	Current/Voltage
4*	RTD, alpha = .00385

\*Units with a model number suffix -0001 indicate an RTD input with alpha = .00392 (instead of alpha = .00385). For example, model number 2030-22844-0001 has two RTD inputs, with alpha = .00392.

Check the model number on the side of your unit to verify the input types.

**NOTE**

If the sensor input card is changed, the controller must be recalibrated and reconfigured. The 2030 is factory calibrated and shipped with the selected sensor card installed. See "Changing Input Cards," page 11, if it is necessary to change the input type/cards.

**NOTE**

Sensor leads (thermocouple, RTD, voltage or current) should not be run together in the same conduit as power wiring. Twisted pair shielded wire is recommended for making sensor connections. False process readings can occur if the sensor wire is exposed to electrical noise.

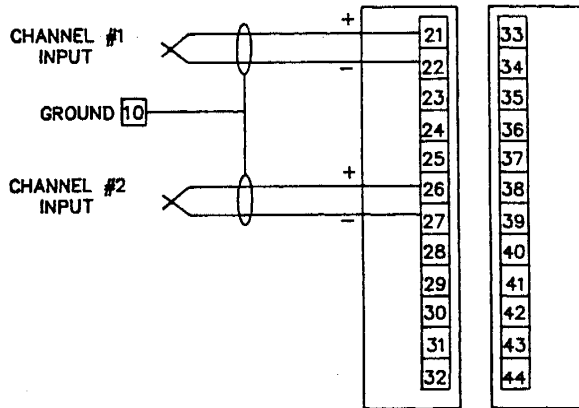
**Thermocouple  
Inputs  
Code 1**

It is important to observe polarity (+,-) when connecting thermocouple lead-wires. The table below shows typical color coding for the thermocouples used with this instrument.

<u>T/C Type</u>	<u>Material</u>	<u>Polarity</u>	
		<u>Plus (+)</u>	<u>Minus (-)</u>
T	Copper/Constantan	Blue	Red

Make the thermocouple wiring connections to terminals 21 and 22 (Channel 1) and terminals 26 and 27 (Channel 2) as shown in Figure 2.5.

**Figure 2.5  
Thermocouple  
Connections**



**NOTES**

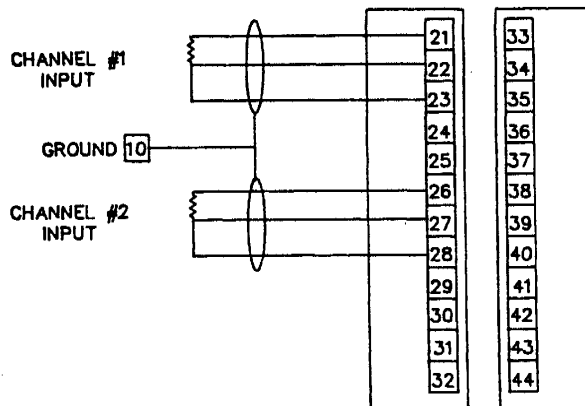
1. If thermocouple extension wire is required, it must be the same type as the thermocouple (i.e. if a Type T thermocouple is used, then Type T extension wire must be used).
2. If shielded thermocouple wire is used, the shield must be grounded at one end only, preferably at terminal 10 on the controller, as shown in Figure 2.5.

**RTD Inputs  
Code 4**

When making the 3-wire RTD input connection, it is important to make the resistance of all three extension leadwires equal by using the same gauge of wire for optimum leadwire compensation. Chromalox recommends 3-wire RTD's for greatest accuracy, and standard shielded copper wire for RTD extensions.

Make the wiring connections in accordance with Figure 2.6 below.

**Figure 2.6  
Three-Wire RTD  
Connections**



**Current/Voltage  
Inputs  
Code 3**

Controller models 2030-\*\*\*\*3 and 2030-\*\*\*3\* are shipped with the 4-20 mA Current input selected. To change the input to 1-5 Vdc, an internal jumper on the input card must be changed. Remove the controller chassis from the case (as instructed on page 5) and locate the Current/Voltage Input card illustrated in Figure 2.7.

**Figure 2.7  
Locating Channel #1 and  
Channel #2 Input Cards**

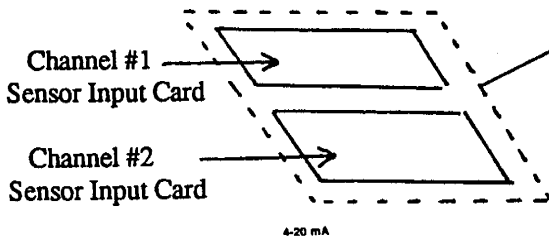
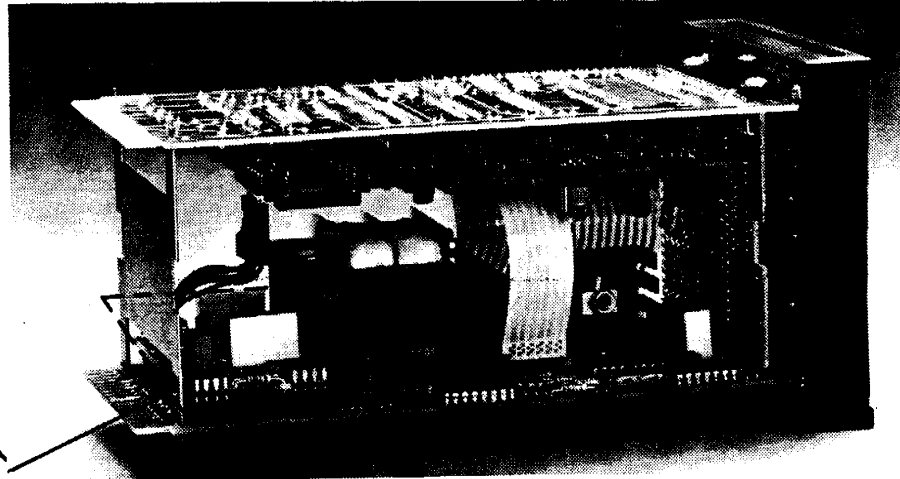
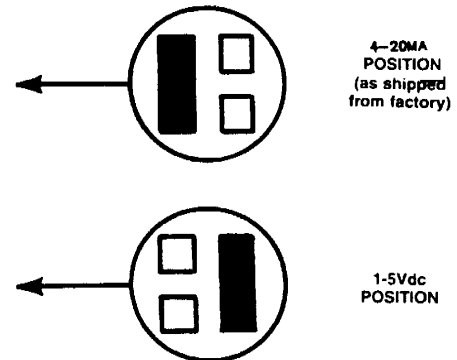
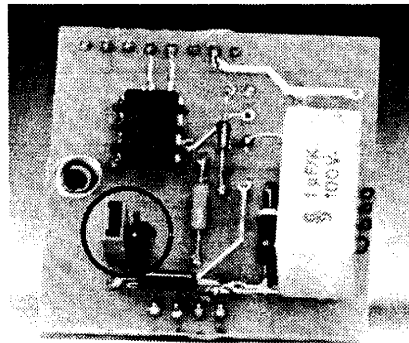


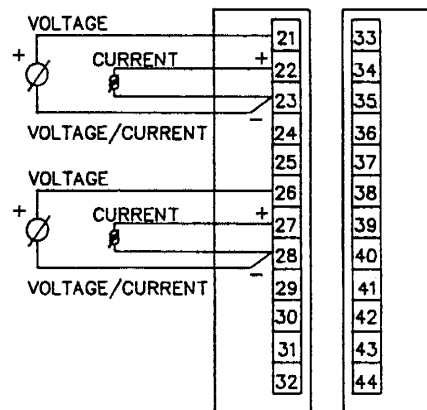
Figure 2.8 illustrates both the 4-20 mA jumper position and 1-5 Vdc jumper position. Place the jumper in the appropriate position for your application.

**Figure 2.8  
Current/Voltage  
Input Card Jumper Positions**



Make the Current/Voltage wiring connections as shown in Figure 2.9.

**Figure 2.9  
Current/Voltage  
Input Connections**

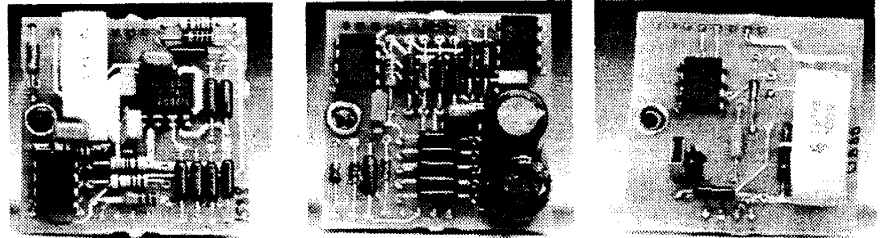


**Changing Input Cards**

The 2030 controller is shipped with the appropriate input card already installed. Should it become necessary to change the input type, the input card can be changed. If it is necessary to change from one type of sensor input to another, the controller must be recalibrated for the new sensor input type, and the sensor selections in PAGE 18/MENU 4-5 must be changed.

To change the input card, remove the controller chassis from its case and locate the input cards as illustrated in Figure 2.7. The following Figure 2.10

**Figure 2.10  
Input Cards**



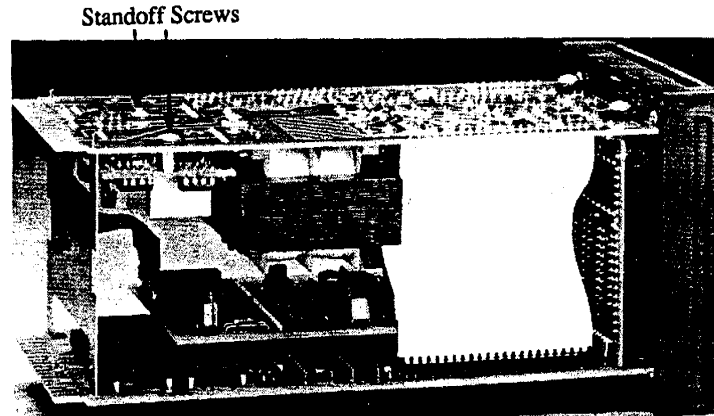
Thermocouple

RTD

Current/Voltage

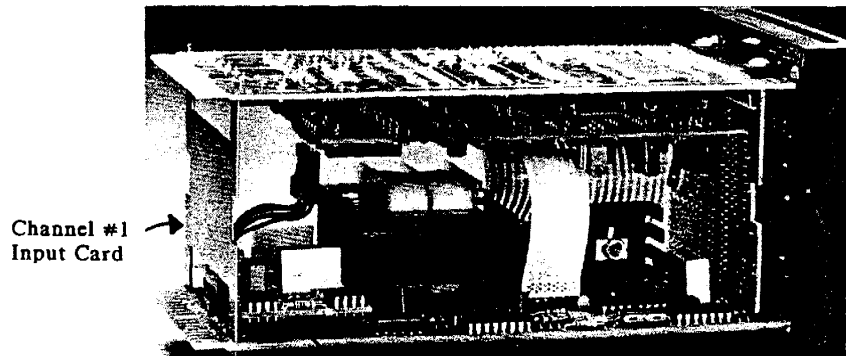
To change the input card, you must first remove the standoff screws that secures the input cards in the controller chassis (see Figure 2.11 below). Gently but firmly unplug the installed input card from the connection pins and replace it with the new input card, then replace the standoff screws. This procedure is illustrated in Figures 2.11 and 2.12 below. After changing input cards, the unit must be recalibrated. See Section 8.

**Figure 2.11  
Input Card Standoff  
Screws**



Standoff Screws

**Figure 2.12  
Changing Input Cards**



Channel #1  
Input Card

Channel #2  
Input Card



## OUTPUT WIRING

Your 2030 controller has up to four Outputs (2 outputs per Channel), as defined by the model number. The controller may function as follows:

Single Channel Controller - Channel #1 only, Heat/Cool

Dual Channel Controller - Channel #1 as Heat/Cool Temperature Control and Channel #2 as Humidify/De-Humidify Control

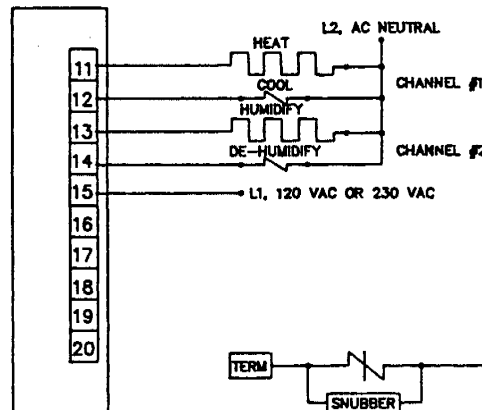
You will program each Channel to function as you choose using the PAGE/MENU programming.

### Solid State Relay Output Connections Code 2

The solid state relay outputs are generally used to drive small resistive loads (<0.5 amps at 120 volts) or a contactor. When driving a contactor coil or other inductive load we recommend that you install an appropriately rated a.c. snubber circuit (Chromalox Part. No. 0149-00012) in parallel with the contactor coil. Snubbers are recommended to protect the controller from electrical noise generated by the inductive load, as discussed earlier in this section.

Make the wiring connections for relay outputs as shown in Figure 2.13.

Figure 2.13  
Solid State Relay Output Connections

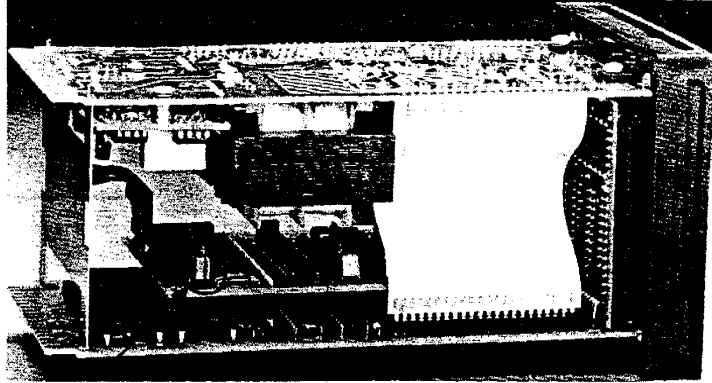


### Current/Voltage Output Connection (Option)

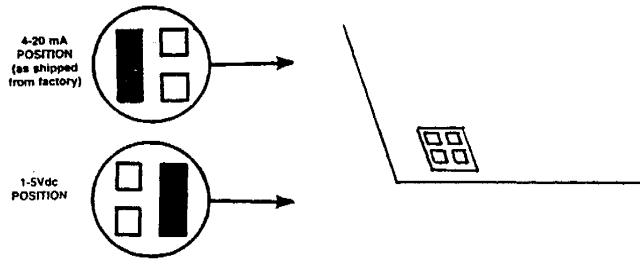
The 4-20 mA signal is an industrial standard method of transmitting and receiving information. The 2030 gives you the option of reassigning this 4-20 mA to represent one of the four Control Outputs. To use this output, it must be connected to a device that accepts a 4-20mA signal and has input impedance of less than 800 ohms.

The output may be changed from a 4-20mA signal to a 1-5Vdc signal by simply moving a jumper on the output module. The controller is shipped with the 4-20mA signal selected. Identify the Current/Voltage Output Modules as described in Figure 2.14, and position the jumper in the 1-5 V position as shown.

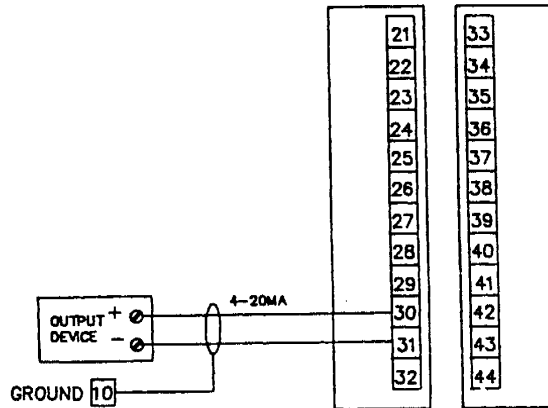
**Figure 2.14**  
**Locating Output Modules**



**Figure 2.15**  
**4-20 mA/1-5 Vdc**  
**Jumper Positions**



**Figure 2.16**  
**4-20 mA/1-5Vdc**  
**Output Connection**



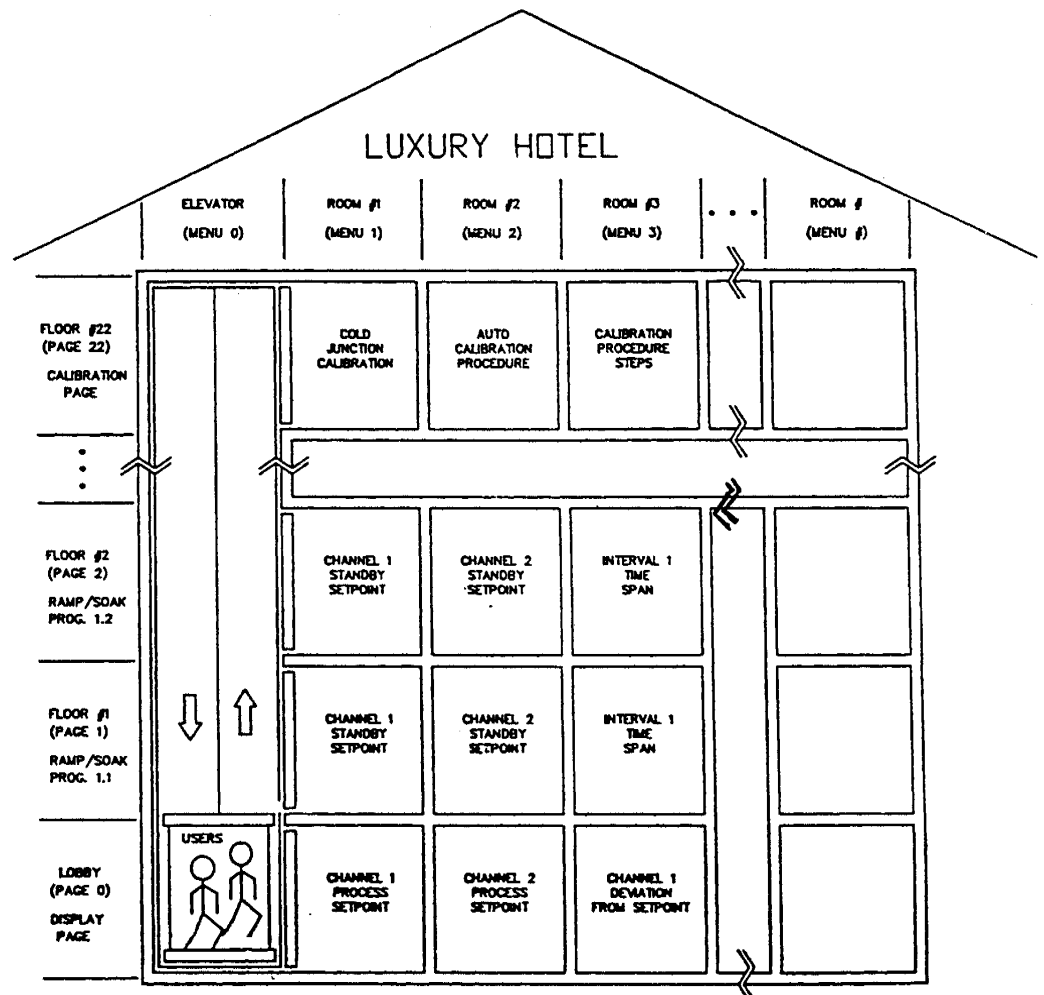
**OPTIONS WIRING CONNECTIONS**

Specific wiring instructions for each of the following options are given in the following sections:

<u>Option</u>	<u>Page</u>
Process or Ramp Profile Analog Output	53
Event Outputs and Alarms	49
Remote Ramp/Soak Operation Inputs	51
Digital Communications	57

**Figure 3.1**  
**PAGE/MENU Programming Concept**

The PAGE/MENU Programming is analogous to groups of related people staying in a luxury hotel. Think of each of the groups of related functions in programming (i.e. Programs 1.1 through 4.4, Nested Program Loops, Calibration, Digital communications) as groups of people. Each group of relatives (functions) is assigned to a different floor (PAGE), and each person (function) has his own room number (MENU #). To visit a certain person in the group (access a certain function in programming), you must enter the hotel by pressing the MENU/VAL pushbutton. You then enter elevator (MENU 0) and proceed to the right floor (PAGE) for the function (person) you are seeking. Then, you must go to their room # (MENU #). When you are ready to leave (finished with programming), you simply go back to the elevator (MENU 0) and proceed down to the lobby (PAGE 0) and exit (PAGE 0 / MENU 0).



# SECTION 3 OPERATION

## PAGE/MENU PROGRAMMING

All control parameters, program settings, and calibration procedures for the 2030 controller are accomplished through simple MENU selections. These MENU selections are organized into PAGES. On each PAGE you will find a specific set of related functions, and each of these functions has a corresponding MENU number. This organization allows you to go directly to the parameter to be adjusted, without stepping through a long series of unnecessary entries.

Figure 3.1 illustrates the concept behind the PAGE/MENU structure, and Figure 3.2 lists the contents of the 22 PAGES in terms of the related functions of the MENU numbers they contain.

## PAGE/MENU TABLES

The detailed individual MENU contents of each PAGE are presented in the PAGE/MENU Tables. These tables give the MENU number, alphanumeric command cue, available settings and the factory/default settings for every adjustment or selection to be made. A sample of part of a PAGE/MENU Table is shown below.

PAGE 18: GENERAL OPERATION <i>L.P.P</i>					
CUE	MENU	SELECTION	AVAILABLE SETTINGS	FACTORY SETTING	SECURITY
<i>BP</i>	8	Barometric Pressure	0 to 99.99 inches of Mercury	29.92 inches	D
ANALOG OUTPUT ASSIGNMENT: In MENU 9 you may select the value that will be assigned to the 4-20 mA/1-5Vdc Analog Output. For more information on application of the Analog Output, see Section 6 of this Manual.					
<i>SPU</i>	9	Process Analog Output Assignment	0 = Analog Output Disabled 1 = Channel #1 Heat Control Output 2 = Channel #1 Cool Control Output 3 = Channel #2 Heat Control Output 4 = Channel #2 Cool Control Output 5 = Channel #1 Process Variable 6 = Channel #2 Process Variable 7 = Channel #1 Set Point 8 = Channel #2 Set Point	6 = Channel #2 Process Variable	
ANALOG BAR GRAPH: MENU 10 allows you to select a variable to be represented by the 0 - 100 Analog Bar Graph Display on the front panel of the controller.					
<i>L.P.P</i>	10	Analog Bar Graph Display Assignment	0 = Disable 1 = Time Left in Interval 2 = Channel #1 Heat Output Command 3 = Channel #1 Cool Output Command 4 = Channel #2 Heat Output Command 5 = Channel #2 Cool Output Command 6 = Channel #1 Deviation from Set Point 7 = Channel #2 Deviation from Set Point	1 = Time Left in Interval	
ALPHANUMERIC CUES: MENU 11 allows you to select alphanumeric cues for PAGES, MENUS and/or VALUES. The alphanumeric cues for PAGES and MENUS are shown in the PAGE/MENU tables throughout this manual. Some, but not all of the VALUES are represented by alphanumeric cues. For example, PAGE 18/MENU 4-5 sensor selection values are represented by both numbers (1 = type T thermocouple) and alphanumeric cues "t tc".					
<i>L.P.P</i>	11	Alphanumeric Cues	0 = No Cues 1 = PAGE Cues 2 = MENU Cues 4 = Value Cues SUM of any of the above settings	7 = PAGE Cues (1) + MENU Cues (2) + Value Cues(4)	

**Figure 3.2**  
**PAGE/MENU Contents**

<b>PAGE</b>	<b>PAGE NAME</b>	<b>PAGE CONTENTS</b>
0	Display	Select from 11 different process variables and values for display in the lower digital display.
<b>Ramp/Soak Program PAGES</b>		
.1 2 3 4 5 6 7 8 9 10 11 12 13 14 15 16	Program 1.1 Program 2.1 Program 3.1 Program 4.1 Program 1.2 Program 2.2 Program 3.2 Program 4.2 Program 1.3 Program 2.3 Program 3.3 Program 4.3 Program 1.4 Program 2.4 Program 3.4 Program 4.4	Interval Set Points, Time Spans, Time Units, Interval Looping, Linkage, Event Outputs, Guaranteed Soak, Auto Hold, Auxiliary Set Points
17	Nested Program Loops	Establish up to 4 Nested Loops between Programs
18	General Operation	Security Level Configuration, Ramp/Soak Program Selection, Sensor Selection, Process Units, Barometric Pressure, Analog Output Assignment, Analog Bar Graph Assignment, Alpha-numeric Cues Enable
19	Channel #1 Control Settings	Set Point, Control Mode, PID Control Parameters, Alarm Parameters
20	Channel #2 Control Settings	
21	Digital Communications	Automatic Data Logging, Terminal Interface Computer Interface, Line Mode
22	Calibration	Quick Step and Manual Calibration Procedures for all sensor types, Cold Junction Compensation Calibration

**Location of  
PAGE/MENU Tables  
in this Manual**

PAGES 0-20 contain all of the general parameters and Ramp/Soak Program selections necessary to get the controller up and running in your application. These PAGES are detailed in the next section, PAGE/MENU Tables. PAGES 21-22 are located in sections specific to their function, Digital Communications and Calibration.

### What's Next?

It is important that you learn more about the controller Security Levels, and the Pushbuttons and Indications before proceeding with actual programming of your unit. A programming practice is given later in this section to familiarize you with the controller operation before you actually put it into service.

### Security Levels

As you can see, every parameter or selection to be made has a corresponding PAGE/MENU number. Each PAGE/MENU number is assigned one of six Security Levels, A-F. In each Level you can view certain PAGE/MENU numbers, and adjust certain PAGE/MENU numbers. This allows you to select the Security Level most appropriate for your operating environment, prohibiting unauthorized access to or accidental changing of control parameters.

The PAGE/MENU Tables indicate the Security Level for each MENU number.

### Entering the Security Code

The Security Code which "unlocks" the Security Level is entered in PAGE 18/MENU 1 to determine which Levels may be viewed, and which may be adjusted. The controller is set at Security Level D when you receive it from Chromalox.

Figure 3.3 defines the PAGE/MENU numbers that correspond to each of the six Security Levels.

**Figure 3.3**  
**PAGE/MENU Contents of Security Levels A-F**

SECURITY LEVEL	FUNCTIONS(S)	PAGE/MENU
A	Display Selection	P0/M1-11
	Security Code	P18/M1
B	Ramp/Soak Program Time Intervals and Set Points	P1-16/M1-26
	Ramp/Soak Program System Loops	P17/M1-20
	Ramp/Soak Program Selection	P18/M2
	Channel #1 Set Point (Single Set Point Control)	P19/M1
	Channel #2 Set Point (Single Set Point Control)	P20/M1
C	Ramp/Soak Program Time Units, Proportional Band, Interval Looping, Linking	P1-16/M27-40
D	Ramp/Soak Program Event Outputs, Guaranteed Soak, Automatic Hold, Alternate Time Units	P1-16/M41-62
	Control Type, Sensor Selection, Process Variable Units, Process Output Assignment, Analog Bar Graph, Alphanumeric Cues	P18/M3-11
	Channel #1 Control and Alarm Parameters	P19/M2-37
	Channel #2 Control and Alarm Parameters	P20/M2-37
E	Digital Communications Set Up	P21/M1-10
F	Quick-Step and Manual Calibration, Sensor Input and Process Output	P22/M1-23

Figure 3.4 lists the six Security Codes for each of the Security Levels, and the Levels which can be viewed and adjusted.

SECURITY LEVEL	SECURITY CODE	VIEW LEVEL	ADJUST LEVEL
A	—	A, B, C, D	A
B	123	A, B, C, D	A, B
C	903	A, B, C, D	A, B, C
D	458	A, B, C, D	A, B, C, D
E	352	A, B, C, D, E	A, B, C, D, E
F	736	A, B, C, D, E, F	A, B, C, D, E, F

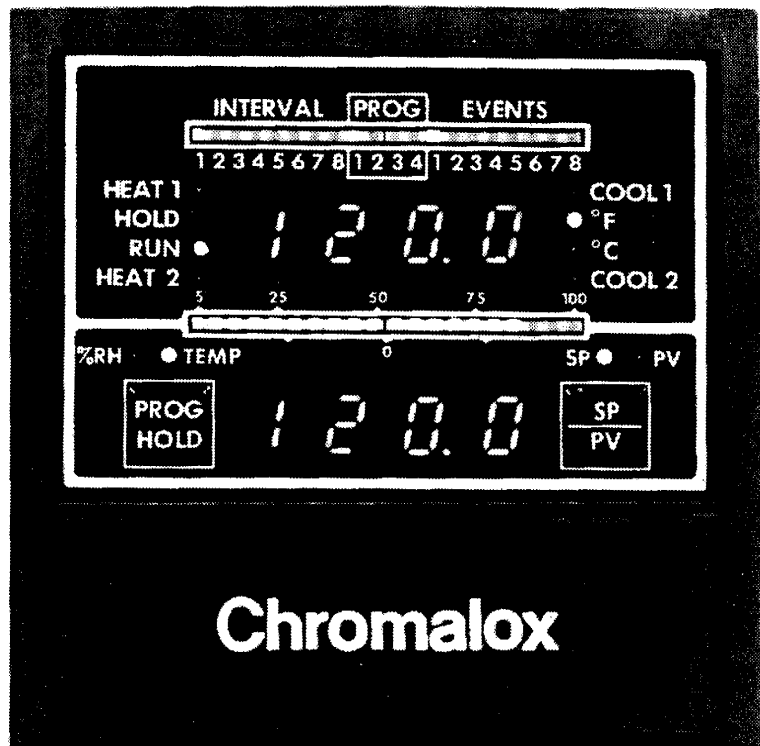
### What's Next?

Next, you will learn how to operate the controller to access these PAGE/MENU functions and what the displays will tell you.

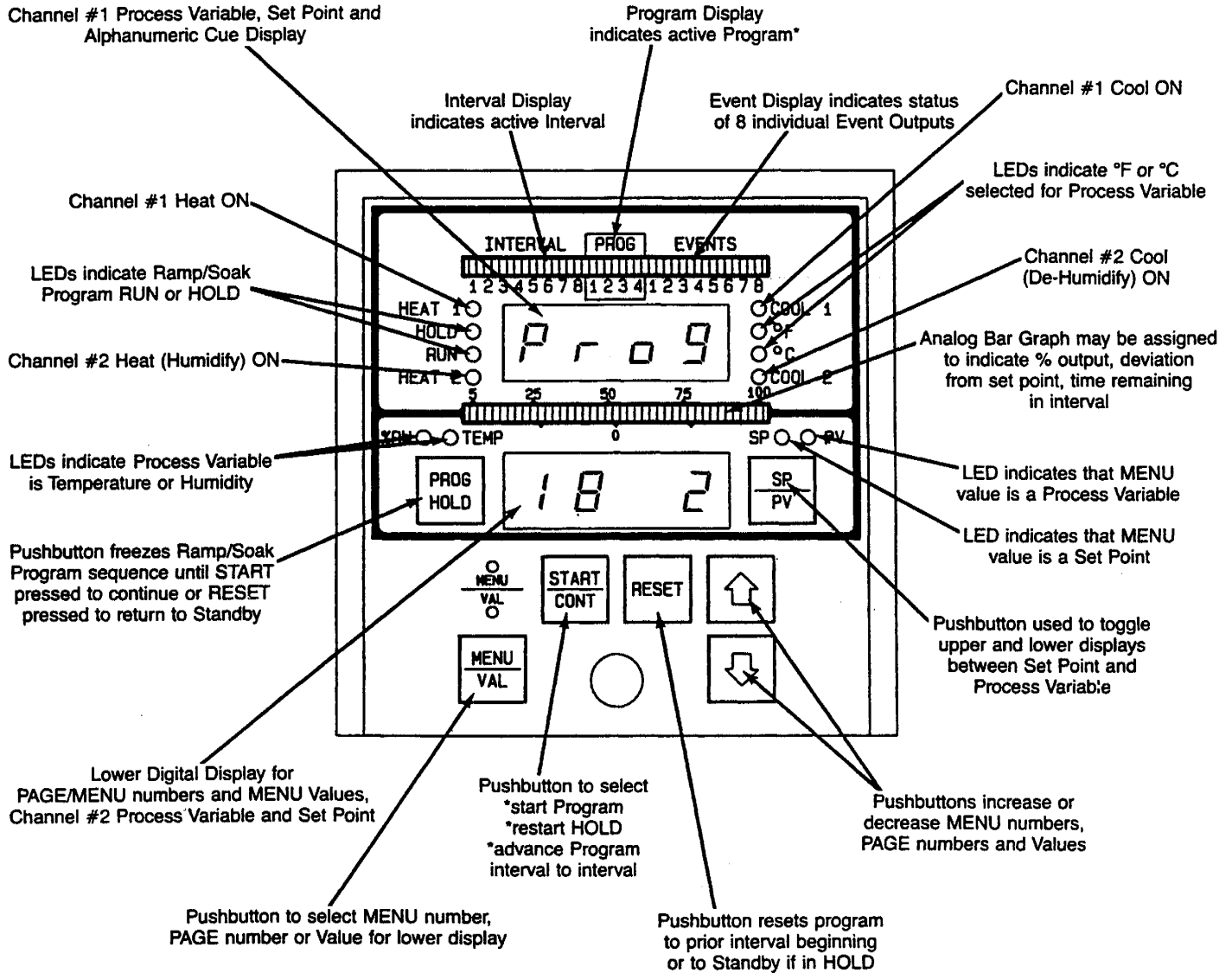
### Pushbuttons and Indications

All of the program control steps and configuration entries are easily accomplished with the front panel pushbuttons. The digital displays and status lights provide a constant overview of the process and ramp/soak profile conditions. Figure 3.5 shows the controller displays and status lights in a normal operating mode, and Figure 3.6 summarizes the functions of the pushbuttons and displays.

Figure 3.5  
Front Panel Displays  
During Normal Operation



**Figure 3.6**  
**Front Panel Displays and Pushbuttons**



\* The 4 PROG LED's indicate which of the 16 Ramp/Soak Programs is running by an easy to understand blinking action. When Program 4.2 is selected, the PROG 2 LED blinks 4 times. Likewise, when Program 3.4 is selected, the PROG 4 LED blinks 3 times.



## Detailed Display and Pushbutton Descriptions

### Digital Displays During Normal Operation

During normal dual channel operation, the upper display reflects the measured process variable for Channel #1 and the lower display reflects the measured process variable for Channel #2. If the controller is functioning in a single channel mode, the measured process variable is displayed in the upper display and process set point is displayed in the lower display.

By pressing the SP/PV pushbutton only once, the display temporarily presents an alphanumeric cue, letting you know that the values you are looking at are Process Variable Channel 1 and Process Variable Channel 2.

The units of these displayed values (°F, °C, or %RH) are indicated by the LED's on the front panel of the instrument. These units are selected in the PAGE/MENU programming set up.

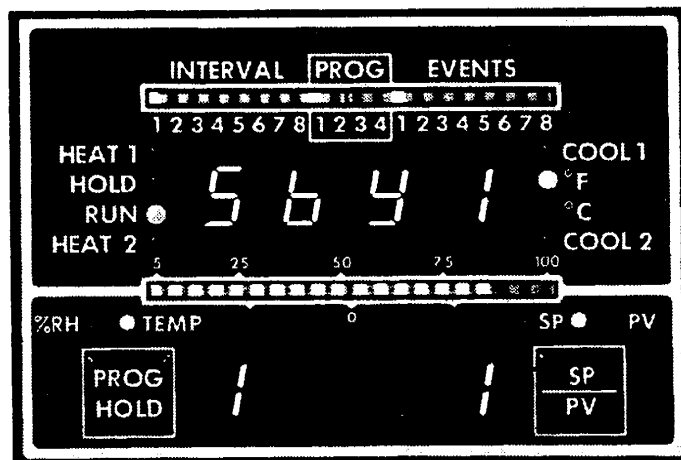
By pressing the SP/PV pushbutton twice, quickly in succession, you can toggle these two displays to show Channel 1 Set Point (upper) and Channel 2 Set Point (lower).

By pressing the SP/PV only once, the displays will temporarily give you an alphanumeric cue, telling you that you are looking at "SP 1" and "SP 2", the current set points for Channels #1 and #2.

### Digital Displays During Programming

During programming, the upper digital display displays the alphanumeric command cue for the PAGE/MENU selection being adjusted. An example of an alphanumeric command cue is shown below:

**Figure 3.7**  
**Alphanumeric Command Cue**  
**"Standby" Set Point**  
**PAGE 1/MENU 1**



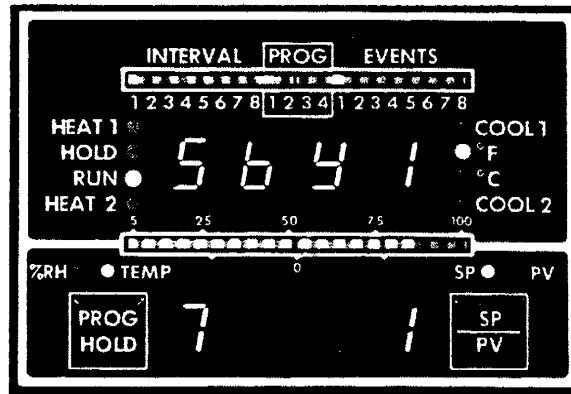
This is the cue for the selection of the Program #1.1 Standby Set Point. The cue will remain in the upper display until MENU/VAL is pressed to select the value for that PAGE/MENU number.

When a PAGE/MENU number has been selected, the upper and lower displays will display the alphanumeric cue and process value or PAGE/MENU number for up to one minute. The displays will then automatically revert back to displaying Channel #1 and Channel #2 Process Variables if no other pushbutton action is taken. The PAGE/MENU number you selected can be easily accessed again by simply pushing the MENU/VAL pushbutton.

During programming, the lower digital display performs the valuable function of indicating which PAGE/MENU numbers you are selecting, and their corresponding values.

An example of the PAGE/MENU number display is shown in Figure 3.8.

**Figure 3.8**  
**PAGE/MENU Number In**  
**Lower Digital Display**



**MENU/VAL Pushbutton** - This pushbutton is used to toggle the lower digital display from PAGE/MENU display to the value of that PAGE/MENU number. THE VAL LED lights when the value is being displayed.

**Programming Practice**

Now that you understand the basic PAGE/MENU programming structure, displays and pushbuttons, you are ready for a practice programming.

**Moving Between PAGES and MENU Numbers**

It is important that you take time to perform this programming practice, It will teach you how to move between PAGES and MENU numbers, and how to adjust MENU values.

**IMPORTANT!**

**DISABLE THE EXTERNAL LOAD CIRCUIT POWER BEFORE PROCEEDING WITH THE PROGRAMMING PRACTICE.**

**Initial Power-Up**







After the 2030 has been properly installed and power is turned on for the first time, it will begin to operate using the factory settings (as shown in the PAGE/MENU Tables). The upper digital display will contain four dashes, "----" and the lower display will contain the controller model number "2030".



After a short delay, during which the controller performs self-tests, the upper display will indicate the Channel #1 process variable (in °F) and the lower display will indicate the Channel #2 process variable. The "PV" LED will be illuminated since the displayed values are process variables. Other LEDs indicating operating status may be illuminated, such as Heat or Cool Output, Temperature, etc.

### Example Set Up

PAGE 4 of the PAGE/MENU Tables contains all of the operational and control parameters for Ramp/Soak Program 4.1. Your goal is to adjust the Standby Set Point, PAGE 4/MENU 1, to 100°F.

To perform the Programming Practice, you must have LEVEL B Security (or higher) entered at PAGE 18/MENU 1.

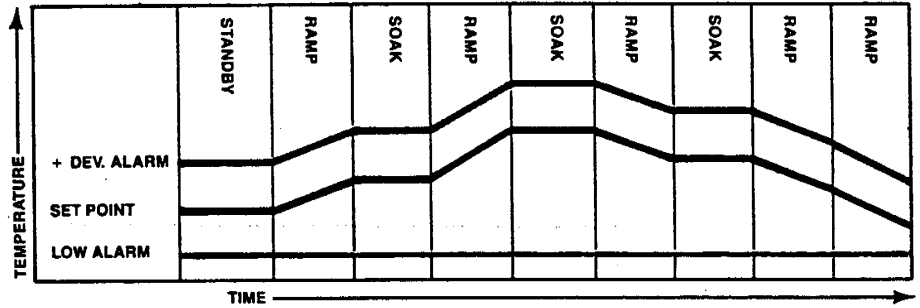
ACTION	WHAT HAPPENS	EXPLANATION
<b>GETTING TO THE PAGE/MENU #:</b>		
1. Press MENU/VAL to access the PAGE select	Upper Display: Alphanumeric cue Lower Display: Current PAGE #	You have accessed the PAGE select function.
2. Press  until "P 4" is displayed	Lower Display: "P 4"  Upper Display: "Pr1.4"	You have moved from PAGE 0 to PAGE 4.
3. Press MENU/VAL again.	Lower Display: Flashing "4 0" lights.	You are now in the MENU select function on PAGE 4 and can advance through the MENU numbers.
4. Press  until MENU 1 is reached.	Lower Display: Flashing "4 1" lights. Upper Display: "Sby1" the alphanumeric for PAGE 4/MENU 1, standby set point.	You are now at PAGE4, MENU 1 and are ready to enter the new value.
<b>ENTER THE NEW MENU VALUE:</b>		
5. Press MENU/VAL again.	The VAL LED will light. Upper Display: Alphanumeric Cue Lower Display: Current MENU value (standby set point) will light.	You are now in the Value select function.
6. Press  or  until "100" is displayed in the lower display.*	Lower Display: "100"	The new Standby set point "100" is automatically entered into memory. Adjustment is complete.
*The  and  pushbuttons increase and decrease the display value faster as they are held pressed.		

ACTION	WHAT HAPPENS	EXPLANATION
<b>RETURN THE CONTROLLER TO THE DISPLAY MODE:</b>		
7. Press MENU/VAL again.	Upper Display: "Sby1", alphanumeric for PAGE 4/MENU 1. Lower Display: "4 1" MENU LED will light.	You have returned to the MENU select function.
8. Press  until MENU "0" is displayed in the lower display.	Lower Display: Flashing "4 0" lights.	Now that you are at MENU 0, you can enter the PAGE select function.
9. Press MENU/VAL again.	MENU LED remains lit. Lower Display: "P 4" indicates you are on PAGE 4. Upper Display: Alphanumeric "Pr1.4" for Program 1.4.	You are in the PAGE select function.
10. Press  until you reach PAGE 0.	Lower Display: "P 0"	You are now on PAGE 0 and are ready to enter the MENU select function on that PAGE.
11. Press MENU/VAL again.	Lower Display: Flashing "0 0"  MENU LED lights	You are now in the MENU select function for PAGE 0.
12. Press SP/PV to return to the display, or wait 1 minute and displays will automatically revert to displaying Process Variables. <b>PROGRAMMING PRACTICE IS COMPLETE!</b>		

# RAMP/SOAK PROGRAM OPERATION

## Intervals

The 2030 Ramp/Soak Controller features 16 individual Programs. Within each program there are 8 intervals plus a standby interval - the time span and set point of each of the 8 intervals being individually adjustable. These 8 intervals constitute what is referred to as the Ramp/Soak Profile. An example of a typical Ramp/Soak Profile is shown below.

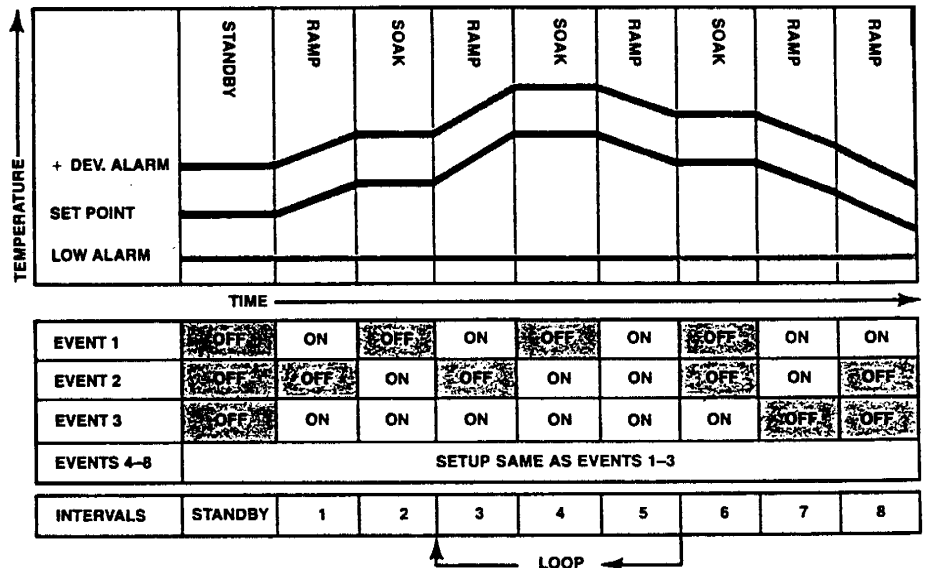


## NOTE

Ramp/Soak Profile Graphs similar to this diagram are provided in the back of this manual to make it easier for you to graphically configure your Ramp/Soak process profiles.

## Event Outputs

Additionally, up to 8 Event Outputs (if you purchased this option) may be configured to be ON or OFF during each of the 8 intervals, as illustrated below:

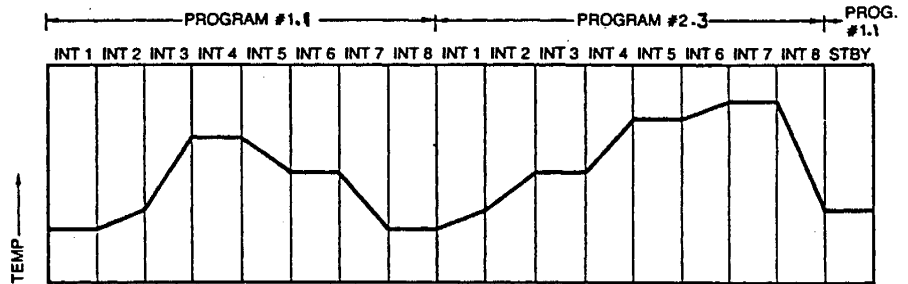


## Alarms

Each control Channel has two alarms, for a total of four Alarms. If used, these alarms may be assigned to the Event Outputs. If this is done, the Event Output can function only as an Alarm and cannot be an Event. Any combination of the 4 alarms may be assigned to the same Event Output, making the output function as a common alarm.

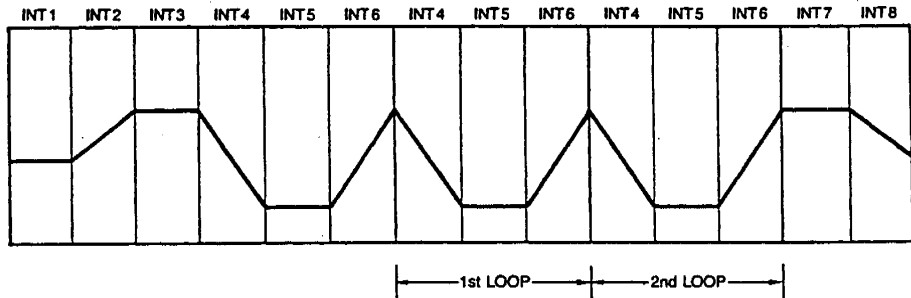
## Linking and Looping

To extend the capabilities of the controller, the Programs may be linked and looped. Linking means that one Program may be "linked" to another program automatically, requiring no operator interface. For example, if Program #1.1 is linked to Program #2.3, as soon as Program #1.1 has completed its cycle, Program #2.3 will begin.



When Program #2.3 is completed, the controller will operate using the Program #1.1 Standby Set Point, assuming that Program #2.3 is not linked to another Program. More detailed information on Linking is given in Appendix I, "Control Theory Tutorial".

**Looping** means that intervals within a Program may be repeated in a looping fashion. If a loop is inserted in the Program so that Intervals 4, 5, and 6 will be repeated 2 times in addition to the single Program run of these intervals, the final process profile would look like this:



You would simply tell the controller to "loop from the end of Interval 6 to the beginning of Interval 4, 2 times" when configuring that Program.

**Up to 3 loops may be established in each of the 16 Programs. Each of these loops has a set priority, which is discussed in detail in the "Control Theory Tutorial," Appendix I, Looping.**

## **Programming the Ramp/Soak Programs**

Each of the 16 Ramp/Soak Programs is programmed on a separate page:

Program #1.1 - PAGE 1	Program #1.3 - PAGE 9
Program #2.1 - PAGE 2	Program #2.3 - PAGE 10
Program #3.1 - PAGE 3	Program #3.3 - PAGE 11
Program #4.1 - PAGE 4	Program #4.3 - PAGE 12
Program #1.2 - PAGE 5	Program #1.4 - PAGE 13
Program #2.2 - PAGE 6	Program #2.4 - PAGE 14
Program #3.2 - PAGE 7	Program #3.4 - PAGE 15
Program #4.2 - PAGE 8	Program #4.4 - PAGE 16

The MENU numbers for each Ramp/Soak Program parameter remain the same from PAGE to PAGE, making it easier for you to learn the programming steps (for example, Program #4.1 Standby Set Point is PAGE 4/MENU 1, and Program #1.4 Standby Set Point is PAGE 13/MENU 1).

On each of the 16 Ramp/Soak Program PAGES, you will select and assign the following for both Channel #1 and Channel #2:

- Standby Set Point
- 8 Time Intervals
- 8 Set Points
- Time Units for Intervals (sec/min/hrs)
- Heat and Cool Proportional Bands (#1 and #2)
- Interval Loops
- Program Links
- Event Outputs ON/OFF during each Interval
- Alarms Assigned as Event Outputs
- Auxiliary Ramp/Soak Set Points

Any of the Program parameters can be changed while another Program is running without interrupting the Program in process.

## **Profile Graphs and Programming Worksheets**

Ramp/Soak Profile Graphs and Programming Worksheets are included in the back of this manual. These "programming tools" are designed to make Program set-up quick and easy, and to provide a permanent record of your Program settings. Pads of 25 worksheets or graphs may be purchased separately (see Part No. in lower right corner of each sheet).

In the following example application, the Profile Graph and Programming Worksheet have been completed to illustrate how to use these programming tools.

**Configuring A  
Ramp/Soak Program**

The next several pages of the manual will present a typical dual channel of the 2030 controller, using Channel #1 as a Heat/Cool Temperature control loop and Channel #2 as a Humidify/De-Humidify control loop.

**Application Description:**

This application is a simple, 4 interval Program. Channel #1 is controlling the temperature, while Channel #2 is controlling humidity. In this example, you will establish the ramp/soak Program 1.1 using the following set points and time intervals:

	<u>Channel #1</u>	<u>Channel #2</u>
Standby Set Points	25.0°C	50.0% RH
Int #1 Set Points	85.0°C	95.0% RH
Int #1 Time	5 minutes	
Int #2 Set Points	Soak	Soak
Int #2 Time	5 minutes	
Int #3 Set Points	5.5°C	95.0% RH
Int #3 Time	5 minutes	
Int #4 Set Points	25.0°C	50.0% RH
Time	10 minutes	

Following the programming worksheets, you can see the individual settings and control parameter adjustments that must be configured for the Program.

Now you can enter these Ramp/Soak Program parameters. Remember that all Program 1.1 programming is done on PAGE 1.

**Security Access**

Make sure that you have accessed Security Level B (or higher) on PAGE 18/MENU 1.

**Select Units  
for Process**

Select "°C" for Channel 1 units on PAGE 18/MENU 6. Select "%" for Channel 2 units on PAGE 18/MENU 7.

**Select Time Units**

Go to PAGE 1/MENU 27 and select "minutes" for the program interval time units.

**Standby Set Points**

Go to PAGE 1/MENU 1 and enter "25.0" for Channel 1 Standby Set Point. Go to PAGE 1/MENU 2 and enter "95.0" for Channel 2 Standby Set Point.

**Interval 1 Time**

Go to PAGE 1/MENU 3 and enter "5.0" minutes for interval 1 time span.

**Interval 1 Set  
Points**

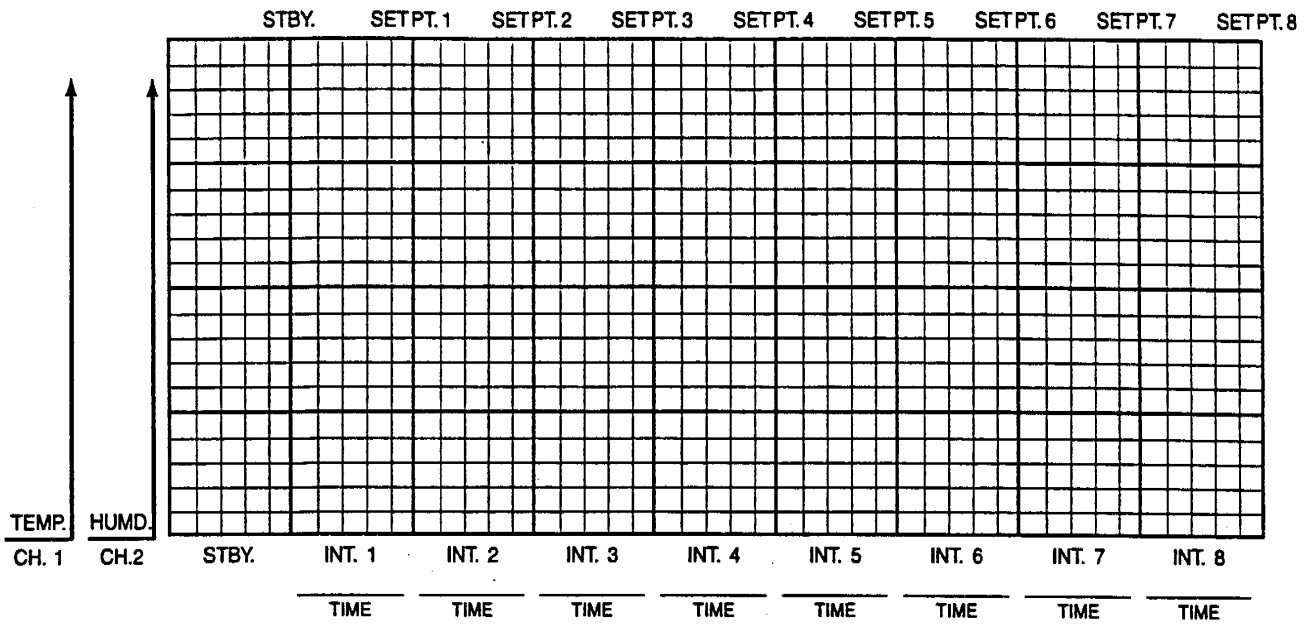
Go to PAGE 1/MENU 4 and enter "85.0" for Channel 1/Interval 1 set point. Go to PAGE 1/MENU 5 and enter "95.0" for Channel 2/Interval 1 set point.

**Interval 2 Time**

Go to PAGE 1/MENU 6 and enter "5.0" minutes for interval 2 time span.



# 2030 Ramp/Soak Profile Graph



	STBY.	INT. 1	INT. 2	INT. 3	INT. 4	INT. 5	INT. 6	INT. 7	INT. 8	Event ON Codes
EVENT 1										1
EVENT 2										2
EVENT 3										4
EVENT 4										8
EVENT 5										16
EVENT 6										32
EVENT 7										64
EVENT 8										128
Total Event ON Codes	_____									

	STBY.	INT. 1	INT. 2	INT. 3	INT. 4	INT. 5	INT. 6	INT. 7	INT. 8	Options ON Codes
SECONDS										1
MINUTES										2
HOURS										4
AUTO HOLD										8
CHANNEL 1 GUARANTEE SOAK										16
CHANNEL 2 GUARANTEE SOAK										32
Total Option ON Codes	_____									

## LOOP #1

Loop from end of Interval  
to beginning of Interval  
How many times?

\_\_\_\_\_  
\_\_\_\_\_  
\_\_\_\_\_

## LOOP #2

Loop from end of Interval  
to beginning of Interval  
How many times?

\_\_\_\_\_  
\_\_\_\_\_  
\_\_\_\_\_

## LOOP #3

Loop from end of Interval  
to beginning of Interval  
How many times?

\_\_\_\_\_  
\_\_\_\_\_  
\_\_\_\_\_

## LINK

Link end of this Program to  
beginning of Program # \_\_\_\_\_

# 2030 Programming Worksheet

PROGRAM# \_\_\_\_\_ PAGE \_\_\_\_\_

PROG. 1.1-4.1 = PAGES 1-4    PROG. 1.3-4.3 = PAGES 9-12  
 PROG. 1.2-4.2 = PAGES 5-8    PROG. 1.4-4.4 = PAGES 13-16

CUE	MENU	SELECTION	YOUR SETTINGS:		
			Date:	Date:	Date:
5bY1	1	Channel #1 Standby Set Point			
5bY2	2	Channel #2 Standby Set Point			
Int1	3	Interval 1 Time Span			
1SP1	4	Channel #1 Set Point 1			
2SP1	5	Channel #2 Set Point 1			
Int2	6	Interval 2 Time Span			
1SP2	7	Channel #1 Set Point 2			
2SP2	8	Channel #2 Set Point 2			
Int3	9	Interval 3 Time Span			
1SP3	10	Channel #1 Set Point 3			
2SP3	11	Channel #2 Set Point 3			
Int4	12	Interval 4 Time Span			
1SP4	13	Channel #1 Set Point 4			
2SP4	14	Channel #2 Set Point 4			
Int5	15	Interval 5 Time Span			
1SP5	16	Channel #1 Set Point 5			
2SP5	17	Channel #2 Set Point 5			
Int6	18	Interval 6 Time Span			
1SP6	19	Channel #1 Set Point 6			
2SP6	20	Channel #2 Set Point 6			
Int7	21	Interval 7 Time Span			
1SP7	22	Channel #1 Set Point 7			
2SP7	23	Channel #2 Set Point 7			
Int8	24	Interval 8 Time Span			
1SP8	25	Channel #1 Set Point 8			
2SP8	26	Channel #2 Set Point 8			
Unit	27	Time Units for this Program			
[1Pb	28	Channel #1 Proportional Band #1 or #2			
[2Pb	29	Channel #2 Proportional Band #1 or #2			
REOP	30	Recovery after Power Outage			
1Fro	31	Loop #1 from end of interval			
1to	32	to beginning of interval #			
1no.	33	# of times			
2Fro	34	Loop #2 from end of interval			
2to	35	to beginning of interval			
2no.	36	# of times			
3Fro	37	Loop #3 from end of interval			
3to	38	to beginning of interval			
3no.	39	# of times			
Link	40	LINK this Program to Program #			
5bEt	41	Standby Event Outputs			
.1Et	42	Interval 1—Event Outputs			
.2Et	43	Interval 2—Event Outputs			
.3Et	44	Interval 3—Event Outputs			
.4Et	45	Interval 4—Event Outputs			
.5Et	46	Interval 5—Event Outputs			
.6Et	47	Interval 6—Event Outputs			
.7Et	48	Interval 7—Event Outputs			
.8Et	49	Interval 8—Event Outputs			

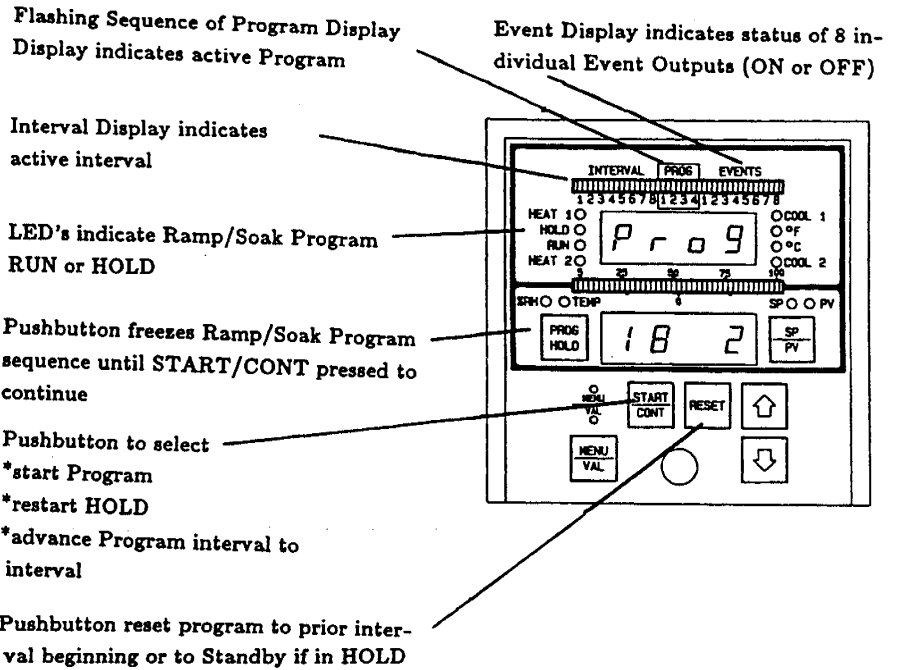
<b>Interval 2 Set Points</b>	Since this is a "soak" interval, the set points will stay the same as interval 1. Go to PAGE 1/MENU 7 and enter "85.0", and PAGE 1/MENU 8 and enter "95.0".
<b>Interval 3 Time</b>	Go to PAGE 1/MENU 9 and enter "5.0" minutes.
<b>Interval 3 Set Points</b>	Go to PAGE 1/MENU 10 and enter "5.5" for Channel 1, Interval 3 set point. Go to PAGE 1/MENU 11 and enter "95.0" for Channel 2, Interval 3 set point.
<b>Interval 4 Time</b>	Go to PAGE 1/MENU 12 and enter "10.0" for interval 4 time span.
<b>Interval 4 Set Points</b>	Go to PAGE 1/MENU 13 and enter "25.0" for Channel 1, Interval 4 set point. Go to PAGE 1/MENU 14 and enter "50.0" for Channel 2, Interval 4 set point.
<b>Remaining Intervals</b>	Since there are 8 intervals available, and only 4 used in this program, you should set the time of the Interval 5 to "0". This will assure that the Program goes to Standby when Interval 4 is completed. Enter the value "0" at PAGE 1/MENU 15 to set the interval time to 0.
<b>What's Next?</b>	Now that you have configured the Ramp/Soak Program, you are ready to select the Program and RUN it!

**Selecting and Running a Ramp/Soak Program**

Once you have completed the Ramp/Soak Programming on PAGES 1-16, you are ready to select and run a Program. The Program # is selected on PAGE 18/MENU 2. Once the Program # is selected, the controller will go to Standby of the newly selected program.

The diagram below recaps the Ramp/Soak pushbutton operations and LED indications.

**Figure 3.9  
Ramp/Soak Pushbutton  
operations and LED Indication**



**NOTE**

If a Program is running when another Program is selected, the controller will complete the currently running Program and go to Standby of the new Program. A Program can also be started from a remote location if your controller contains the Remote Operation Input Option (see page 49).

**Starting a Program**

Once the Program has been selected (PAGE 18/MENU 2), press START/CONT to start it. Continuing to press this pushbutton will manually advance the Program to the beginning of the next interval. At the completion of a Program, the controller will automatically go to Standby, unless the Program is linked to itself or to another Program.

**Selecting Intervals**

Press START/CONT to advance the Program to the beginning of the next interval. Press STOP/RESET to return the Program to the beginning of the previous interval.

**Going to Standby**

To interrupt the running Program and enter Standby, press HOLD, which freezes the Program. Then press STOP/RESET to go to Standby. When the controller is in Standby,  
 no Interval LED's are illuminated  
 the active Program # is illuminated, and  
 the RUN LED is not illuminated.

**Going to a New Program**

While the controller is in Standby, you can switch to another Program (PAGE 18/MENU 2). Once the new Program is selected, the controller will go to the Standby set point of the newly selected Program. As stated earlier, if a Program is running when a new Program is selected, the new Program will not begin until the currently running Program is completed.

**Going to HOLD**

Pressing HOLD stops the Program in the current interval. The controller retains the time remaining in the interval and the set point until it is manually restarted by pressing START/CONT.

## SINGLE SET POINT OPERATION

If you want to apply the controller as a single set point controller (no ramp/soak operations), you simply select "0 = Single Set Point Control" as the Program Selection at PAGE 18/MENU 2 and enter the process set point at PAGE 19-20/MENU 1. Also, select the "Controller Type" on PAGE 18/MENU 3. The controller will still function as a one or two channel control, and no Ramp/Soak programming is necessary on PAGES 1-16. The Event Outputs cannot be used when the controller is functioning as a single set point controller.

### What's Next?



**You are now ready to proceed with Programming your Chromalox 2030 Ramp/Soak Process Controller! Following are the PAGE/MENU Tables from which you can make decisions about the settings and parameters for your application. Be sure to use the Programming Worksheets and Ramp/Soak Profile Graphs in the back of the manual to set up and record your programming.**

## SECTION 4 PAGE/MENU TABLES

This section contains detailed programming information for PAGES 0-20:

PAGE 0	- Display
PAGE 1-16	- Ramp/Soak Programs 1.1 - 4.4
PAGE 17	- System Loop Nesting
PAGE 18	- General Operation
PAGE 19	- Channel #1 Control and Alarm Parameters
PAGE 20	- Channel #2 Control and Alarm Parameters

Following these tables, select the parameter values for your application, log them on the Programming Worksheets in the back of this manual, and program the 2030 controller.

PAGE 0: DISPLAY <i>DISP</i>			
CUE	MENU #	DISPLAY	SECURITY LEVEL
<i>C1SP</i>	1	Channel #1 Process set point in units of process variable	 A 
<i>C2SP</i>	2	Channel #2 Process set point in units of process variable	
<i>C1DE</i>	3	Channel #1 Deviation from set point in units of process variable	
<i>C2DE</i>	4	Channel #2 Deviation from set point in units of process variable	
<i>prog</i>	5	Program Number	
<i>int</i>	6	Interval Number	
<i>LEFT</i>	7	Time Left in Interval	
<i>C1HL</i>	8	Channel #1 Heat Output command in % full ON	
<i>C1CL</i>	9	Channel #1 Cool Output command in % full ON	
<i>C2HL</i>	10	Channel #2 Heat Output command in % full ON	
<i>C2CL</i>	11	Channel #2 Cool Output command in % full ON	

**PAGE 1-16: RAMP/SOAK PROGRAMS 1.1 - 4.4**

PAGE 1 = Program 1.1  
 PAGE 2 = Program 2.1  
 PAGE 3 = Program 3.1  
 PAGE 4 = Program 4.1

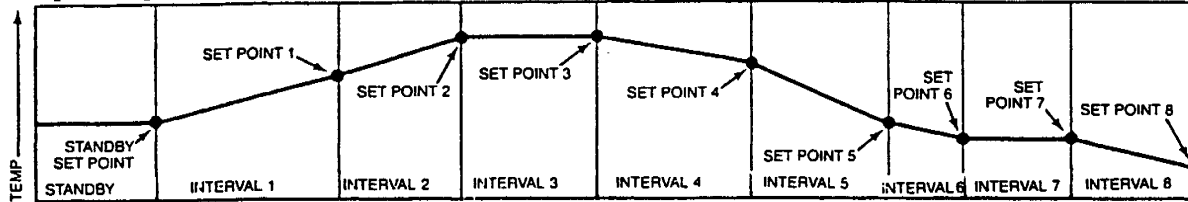
PAGE 5 = Program 1.2  
 PAGE 6 = Program 2.2  
 PAGE 7 = Program 3.2  
 PAGE 8 = Program 4.2

PAGE 9 = Program 1.3  
 PAGE 10 = Program 2.3  
 PAGE 11 = Program 3.3  
 PAGE 12 = Program 4.3

PAGE 13 = Program 1.4  
 PAGE 14 = Program 2.4  
 PAGE 15 = Program 3.4  
 PAGE 16 = Program 4.4

CUE	MENU	SELECTION	AVAILABLE SETTINGS	FACTORY SETTING	SEC.
-----	------	-----------	--------------------	-----------------	------

Ramp/Soak Program Set Up: In MENUs 1-26 you will establish the times and set points for each of the 8 intervals and the standby interval that make up a Ramp/Soak Program. Time units (seconds, minutes, hours) are selected in MENU 27.



<i>5641</i>	1	Channel #1 Standby Set Point	Set Point Span	77°F	B
<i>5642</i>	2	Channel #2 Standby Set Point		50.0% RH	
<i>1761</i>	3	Interval 1 Time Span	0 = End Program 1 to 9999 seconds 0.1 to 999.9 minutes 0.01 to 99.99 hours (dependent on time units chosen in MENU 27)	0.0 minutes	
<i>1571</i>	4	Channel #1 Set Point 1	Set Point Span	77°F	
<i>2571</i>	5	Channel #2 Set Point 1		50.0% RH	
<i>1762</i>	6	Interval 2 Time Span	0 = End Program 1 to 9999 seconds 0.1 to 999.9 minutes 0.01 to 99.99 hours (dependent on time units chosen in MENU 27)	0.0 minutes	
<i>1572</i>	7	Channel #1 Set Point 2	Set Point Span	77°F	
<i>2572</i>	8	Channel #2 Set Point 2		50.0% RH	
<i>1763</i>	9	Interval 3 Time Span	0 = End Program 1 to 9999 seconds 0.1 to 999.9 minutes 0.01 to 99.99 hours (dependent on time units chosen in MENU 27)	0.0 minutes	
<i>1573</i>	10	Channel #1 Set Point 3	Set Point Span	77°F	
<i>2573</i>	11	Channel #2 Set Point 3		50.0% RH	
<i>1764</i>	12	Interval 4 Time Span	0 = End Program 1 to 9999 seconds 0.1 to 999.9 minutes 0.01 to 99.99 hours (dependent on time units chosen in MENU 27)	0.0 minutes	
<i>1574</i>	13	Channel #1 Set Point 4	Set Point Span	0°F	
<i>2574</i>	14	Channel #2 Set Point 4		%	

**PAGE 1-16: RAMP/SOAK PROGRAMS 1.1 - 4.4**

PAGE 1 = Program 1.1  
 PAGE 2 = Program 2.1  
 PAGE 3 = Program 3.1  
 PAGE 4 = Program 4.1

PAGE 5 = Program 1.2  
 PAGE 6 = Program 2.2  
 PAGE 7 = Program 3.2  
 PAGE 8 = Program 4.2

PAGE 9 = Program 1.3  
 PAGE 10 = Program 2.3  
 PAGE 11 = Program 3.3  
 PAGE 12 = Program 4.3

PAGE 13 = Program 1.4  
 PAGE 14 = Program 2.4  
 PAGE 15 = Program 3.4  
 PAGE 16 = Program 4.4

CUE	MENU	SELECTION	AVAILABLE SETTINGS	FACTORY SETTING	SEC.
<i>Int5</i>	15	Interval 5 Time Span	0 = End Program 1 to 9999 seconds 0.1 to 999.9 minutes 0.01 to 99.99 hours (dependent on time units chosen in MENU 27)	0.0 minutes	B
<i>ISP5</i>	16	Channel #1 Set Point 5	Set Point Span	77.0°F	
<i>ZSP5</i>	17	Channel #2 Set Point 5		50% RH	
<i>Int6</i>	18	Interval 6 Time Span	0 = End Program 1 to 9999 seconds 0.1 to 999.9 minutes 0.01 to 99.99 hours (dependent on time units chosen in MENU 27)	0.0 minutes	
<i>ISP6</i>	19	Channel #1 Set Point 6	Set Point Span	77.0°F	
<i>ZSP6</i>	20	Channel #2 Set Point 6		50% RH	
<i>Int7</i>	21	Interval 7 Time Span	0 = End Program 1 to 9999 seconds 0.1 to 999.9 minutes 0.01 to 99.99 hours (dependent on time units chosen in MENU 27)	0.0 minutes	
<i>ISP7</i>	22	Channel #1 Set Point 7	Set Point Span	77.0°F	
<i>ZSP7</i>	23	Channel #2 Set Point 7		50% RH	
<i>Int8</i>	24	Interval 8 Time Span	0 = End Program 1 to 9999 seconds 0.1 to 999.9 minutes 0.01 to 99.99 hours (dependent on time units chosen in MENU 27)	0.0 minutes	
<i>ISP8</i>	25	Channel #1 Set Point 8	Set Point Span	77.0°F	
<i>ZSP8</i>	26	Channel #2 Set Point 8		50% RH	
<i>Unit</i>	27	Time Units	1 = 1 to 9999 seconds 2 = 0.1 to 999.9 minutes 3 = 0.01 to 99.99 hours	2 = 0.1 to 999.9 minutes	C
<b>SELECT PROPORTIONAL BAND #1 OR #2 - as programmed on PAGE 19-20/MENU 3-6 - to be used in running this Program.</b>					
<i>CIPb</i>	28	Channel #1 Proportional Band	1 = Proportional Band #1 2 = Proportional Band #2	1 = Heat Prop. Band #1	
<i>CZPb</i>	29	Channel #2 Proportional Band	1 = Proportional Band #1 2 = Proportional Band #2	1 = Cool Prop. Band #1	
<b>POWER OUTAGE RECOVERY</b>					
<i>REOP</i>	30	Recovery Options after Power Outage	0 = Go to Standby 1 = Resume Program 2 = Hold at Current Oper. Status	2 = Hold at Current Status	



**PAGE 1-16: RAMP/SOAK PROGRAMS 1.1 - 4.4**

PAGE 1 = Program 1.1  
 PAGE 2 = Program 2.1  
 PAGE 3 = Program 3.1  
 PAGE 4 = Program 4.1

PAGE 5 = Program 1.2  
 PAGE 6 = Program 2.2  
 PAGE 7 = Program 3.2  
 PAGE 8 = Program 4.2

PAGE 9 = Program 1.3  
 PAGE 10 = Program 2.3  
 PAGE 11 = Program 3.3  
 PAGE 12 = Program 4.3

PAGE 13 = Program 1.4  
 PAGE 14 = Program 2.4  
 PAGE 15 = Program 3.4  
 PAGE 16 = Program 4.4

CUE	MENU	SELECTION	AVAILABLE SETTINGS	FACTORY SETTING	SEC.
<b>INTERVAL LOOPING AND PROGRAM LINKING SET-UP:</b> In MENUs 31-39, you may establish up to 3 separate interval loops. In MENU 40 you can link this Program to any other Program, or to itself.					
<i>1 Frd</i>	31	LOOP 1 - Loop from the end of Interval A	A = 0 to 8	0 = Disable	C
<i>1 Ed</i>	32	to the beginning of Interval B	B = 0 to 8	0 = Disable	
<i>1 nD.</i>	33	C number of times	C = 0 to 255 (0 = Continuous)	1 = Once	
<i>2 Frd</i>	34	LOOP 2 - Loop from the end of Interval A	A = 0 to 8	0 = Disable	C
<i>2 Ed</i>	35	to the beginning of Interval B	B = 0 to 8	0 = Disable	
<i>2 nD.</i>	36	C number of times	C = 0 to 255 (0 = Continuous)	1 = Once	
<i>3 Frd</i>	37	LOOP 3 - Loop from the end of Interval A	A = 0 to 8	0 = Disable	C
<i>3 Ed</i>	38	to the beginning of Interval B	B = 0 to 8	0 = Disable	
<i>3 nD.</i>	39	C number of times	C = 0 to 255 (0 = Continuous)	1 = Once	
<i>Link</i>	40	LINK the end of this Program to the beginning of Program #	0 = No Linking 1 = Program #1.1 2 = Program #2.1 3 = Program #3.1 4 = Program #4.1 5 = Program #1.2 6 = Program #2.2 7 = Program #3.2 8 = Program #4.2 9 = Program #1.3 10 = Program #2.3 11 = Program #3.3 12 = Program #4.3 13 = Program #1.4 14 = Program #2.4 15 = Program #3.4 16 = Program #4.4	0 = No Linking	

**PAGE 1-16: RAMP/SOAK PROGRAMS 1.1 - 4.4**

PAGE 1 = Program 1.1	PAGE 5 = Program 1.2	PAGE 9 = Program 1.3	PAGE 13 = Program 1.4
PAGE 2 = Program 2.1	PAGE 6 = Program 2.2	PAGE 10 = Program 2.3	PAGE 14 = Program 2.4
PAGE 3 = Program 3.1	PAGE 7 = Program 3.2	PAGE 11 = Program 3.3	PAGE 15 = Program 3.4
PAGE 4 = Program 4.1	PAGE 8 = Program 4.2	PAGE 12 = Program 4.3	PAGE 16 = Program 4.4

CUE	MENU	SELECTION	AVAILABLE SETTINGS	FACTORY SETTING	SEC.
-----	------	-----------	--------------------	-----------------	------

**EVENT OUTPUT SET UP:** Detailed instructions for Event Output Set Up are given in Section 5 of this manual. Simply enter the sum of Event "ON" Codes at the MENU numbers corresponding to the Intervals. For example, to have Event Outputs 2, 6, and 7 turn on in Interval 3, set MENU 44 value to 2 + 32 + 64 = 98.

Event Output #	ON Code	Event Output #	ON Code
1	1	5	16
2	2	6	32
3	4	7	64
4	8	8	128

<i>5bEt</i>	41	Standby	0 to 255 (Any Sum of Event ON Codes)	0	D
<i>1 Et</i>	42	Interval 1		0	
<i>2 Et</i>	43	Interval 2		0	
<i>3 Et</i>	44	Interval 3		0	
<i>4 Et</i>	45	Interval 4		0	
<i>5 Et</i>	46	Interval 5		0	
<i>6 Et</i>	47	Interval 6		0	
<i>7 Et</i>	48	Interval 7		0	
<i>8 Et</i>	49	Interval 8		0	

**OPTIONAL PROGRAM SET UPS:** The following Options may be assigned ON in any interval by adding the ON Codes and entering the sum at the MENU number corresponding to the appropriate interval.

Change time units from those specified in MENU 27:

Seconds OFF = 0	ON = 1
Minutes OFF = 0	ON = 2
Hours OFF = 0	ON = 4

Hold after Interval completed. (Puts unit on hold at the end of the interval. All Events ON in that Interval will remain ON until the Program is "Continued").

OFF = 0 ON = 8

Guaranteed Soak assures that the soaking time in an interval does not begin until the process reaches set point. Guaranteed Soak Differential set in MENUs 59-60.

Channel #1 OFF = 0	ON = 16
Channel #2 OFF = 0	ON = 32

<i>5 DP</i>	50	Standby	0 to 63	0	D
<i>1 DP</i>	51	Interval 1	0 to 63	0	
<i>2 DP</i>	52	Interval 2	0 to 63	0	
<i>3 DP</i>	53	Interval 3	0 to 63	0	
<i>4 DP</i>	54	Interval 4	0 to 63	0	
<i>5 DP</i>	55	Interval 5	0 to 63	0	
<i>6 DP</i>	56	Interval 6	0 to 63	0	

PAGE 1-16: RAMP/SOAK PROGRAMS 1.1 - 4.4					
PAGE 1 = Program 1.1	PAGE 5 = Program 1.2	PAGE 9 = Program 1.3	PAGE 13 = Program 1.4		
PAGE 2 = Program 2.1	PAGE 6 = Program 2.2	PAGE 10 = Program 2.3	PAGE 14 = Program 2.4		
PAGE 3 = Program 3.1	PAGE 7 = Program 3.2	PAGE 11 = Program 3.3	PAGE 15 = Program 3.4		
PAGE 4 = Program 4.1	PAGE 8 = Program 4.2	PAGE 12 = Program 4.3	PAGE 16 = Program 4.4		
CUE	MENU	SELECTION	AVAILABLE SETTINGS	FACTORY SETTING	SEC.
7DP	57	Interval 7	0 to 63	0	D
8DP	58	Interval 8	0 to 63	0	
C105	59	Guar. Soak Differential for Channel #1	0.1 to 25.5% span	1.0% span	
C205	60	Guar. Soak Differential for Channel #2		1.0% span	

PAGE 17: RAMP/SOAK NESTED PROGRAM LOOPS					
CUE	MENU	SELECTION	AVAILABLE SETTINGS	FACTORY SETTING	SEC.
<b>NESTED PROGRAM LOOPS:</b> In MENU 1-20, you may specify up to 4 nested Program Loops by simply specifying the "from" Program/Interval, the "to" Program Interval, and the number of times the loop is to be run. See Appendix I, "Control Theory Tutorial" for specific information on the prioritization of the Nested Program Loops.					
<b>NESTED LOOP #1</b>					
1FP	1	Loop from Program A=	0 = No Looping 1 = Program #1.1 2 = Program #2.1 3 = Program #3.1 4 = Program #4.1 5 = Program #1.2 6 = Program #2.2 7 = Program #3.2 8 = Program #4.2 9 = Program #1.3 10 = Program #2.3 11 = Program #3.3 12 = Program #4.3 13 = Program #1.4 14 = Program #2.4 15 = Program #3.4 16 = Program #4.4	0 = Disabled	B
1Fin	2	Interval B=	B = 1 to 8	1	
1tPr	3	to Program C=	1 - 16 = Program #1.1 - #4.4 See MENU 1 selections	1	
1tIn	4	Interval D=	D = 1 to 8	1	
1no.	5	E number of times	E = 0 to 255 (0 = Continuous)	0	
<b>NESTED LOOP #2</b>					
2FP	6	Loop from Program A=	0 = No Looping 1 - 16 = Program #1.1 - #4.4 See MENU 1 selections	0 = Disabled	B
2Fin	7	Interval B=	B = 1 to 8	1	
2tPr	8	to Program C=	1 - 16 = Program #1.1 - #4.4 See MENU 1 selections	1	
2tIn	9	Interval D=	D = 1 to 8	1	
2no.	10	E number of times	E = 0 to 255 (0 = Continuous)	0	

**PAGE 17: RAMP/SOAK NESTED PROGRAM LOOPS**

CUE	MENU	SELECTION	AVAILABLE SETTINGS	FACTORY SETTING	SEC.
<b>NESTED LOOP #3</b>					
3FPT	11	Loop from Program A=	0 = No Looping 1 - 16 = Program #1.1 - #4.4 See MENU 1 selections	0 = Disabled	B
3FIN	12	Interval B=	B = 1 to 8	1	
3LPT	13	to Program C=	1 - 16 = Program #1.1 - #4.4 See MENU 1 selections	1	
3LIN	14	Interval D=	D = 1 to 8	1	
3no.	15	E number of times	E = 0 to 255	0	
<b>NESTED LOOP #4</b>					
4FPT	16	Loop from Program A=	0 = No Looping 1 - 16 = Program #1.1 - #4.4	0 = Disabled	B
4FIN	17	Interval B=	B = 1 to 8	1	
4LPT	18	to Program C=	1 - 16 = Program #1.1 - #4.4 See MENU 1 selections	1	
4LIN	19	Interval D=	D = 1 to 8	1	
4no.	20	E number of times	E = 0 to 255 (0 = Continuous)	0	

PAGE 18: GENERAL OPERATION

CUE	MENU	SELECTION	AVAILABLE SETTINGS	FACTORY SETTING	SEC.
<i>Loch</i>	1	Security Lock	Security Codes (0 to 9999)	458 = Level D	A
<i>prog</i>	2	Program Selection	0 = None (Single set point control, Ramp/Soak Program not selected) 1 = Program #1.1 2 = Program #2.1 3 = Program #3.1 4 = Program #4.1 5 = Program #1.2 6 = Program #2.2 7 = Program #3.2 8 = Program #4.2 9 = Program #1.3 10 = Program #2.3 11 = Program #3.3 12 = Program #4.3 13 = Program #1.4 14 = Program #2.4 15 = Program #3.4 16 = Program #4.4		B
<i>Cont</i>	3	Controller Type	1 = Single Channel Controller 2 = Dual Channel Controller Channel #1 = temperature Channel #2 = humidity 3 = Dual Channel Controller Channel #1 = temperature Channel #2 = temperature	2 = Dual Channel Temp/Humd	D
<i>SEN1</i>	4	Sensor Input Selection Channel #1	1 = T Thermocouple 2 = 100 ohm Platinum RTD, High Range -110.0 to 425.0°F 3 = 100 ohm Platinum Rtd, Low Range 32.0 to 212.0°F 4 = 4-20 mA (1-5 Vdc)	2 = RTD, High	
<i>SEN2</i>	5	Sensor Input Selection Channel #2	1 = T Thermocouple 2 = 100 ohm Platinum RTD, High Range -110.0 to 425.0°F 3 = 100 ohm Platinum Rtd, Low Range 32.0 to 212.0°F 4 = 4-20 mA (1-5 Vdc)	3 = RTD, Low	
<i>Un 1</i>	6	Channels #1 and #2 Temperature Units or Channel #1 Units for 4-20 mA/ 1-5Vdc	1 = °F or 0.0 to 100.0% 2 = °C or 0 to 100% 3 = 0.00 to 99.99% (Basic)	1 = °F	D
<i>Un 2</i>	7	Channel #2 Relative Humidity Units or Units for 4-20 mA/ 1-5Vdc	1 = 0.0 to 100.0% 2 = 0 to 100% 3 = 0.00 to 99.99% (Basic)	1 = Relative Humidity	D

PAGE 18: GENERAL OPERATION					
CUE	MENU	SELECTION	AVAILABLE SETTINGS	FACTORY SETTING	SEC.
<i>BP</i>	8	Barometric Pressure	0 to 99.99 inches of Mercury	29.92 inches	D
<b>ANALOG OUTPUT ASSIGNMENT:</b> In MENU 9 you may select the value that will be assigned to the 4-20 mA/1-5Vdc Analog Output. For more information on application of the Analog Output, see Section 6 of this Manual.					
<i>AOut</i>	9	Process Analog Output Assignment	0 = Analog Output Disabled 1 = Channel #1 Heat Control Output 2 = Channel #1 Cool Control Output 3 = Channel #2 Heat Control Output 4 = Channel #2 Cool Control Output 5 = Channel #1 Process Variable 6 = Channel #2 Process Variable 7 = Channel #1 Set Point 8 = Channel #2 Set Point	6 = Channel #2 Process Variable	
<b>ANALOG BAR GRAPH:</b> MENU 10 allows you to select a variable to be respresented by the 0 - 100 Analog Bar Graph Display on the front panel of the controller.					
<i>AG-</i>	10	Analog Bar Graph Display Assignment	0 = Disable 1 = Time Left in Interval 2 = Channel #1 Heat Output Command 3 = Channel #1 Cool Output Command 4 = Channel #2 Heat Output Command 5 = Channel #2 Cool Output Command 6 = Channel #1 Deviation from Set Point 7 = Channel #2 Deviation from Set Point	1 = Time Left in Interval	
<b>ALPHANUMERIC CUES:</b> MENU 11 allows you to select alphanumeric cues for PAGES, MENUS and/or VALUES. The alphanumeric cues for PAGES and MENUS are shown in the PAGE/MENU tables throughout this manual. Some, but not all of the VALUES are represented by alphanumeric cues. For example, PAGE 18/MENU 4-5 sensor selection values are represented by both numbers (1 = type T thermocouple) and alphanumeric cues "t tc".					
<i>LABL</i>	11	Alphanumeric Cues	0 = No Cues 1 = PAGE Cues 2 = MENU Cues 4 = Value Cues SUM of any of the above settings	7 = PAGE Cues (1) + MENU Cues (2) + Value Cues(4)	

**PAGE 19: CHANNEL #1 BIMODAL CONTROL AND ALARM PARAMETERS** *C15U*  
**PAGE 20: CHANNEL #2 BIMODAL CONTROL AND ALARM PARAMETERS** *C25U*

CUE	MENU	SELECTION	AVAILABLE SETTINGS	FACTORY SETTING	SEC.
<i>SP</i>	1	Set Point (for single set point operation - no Ramp/Soak Program selected)	Instrument Sensor Range	PAGE 19: 77.0°F PAGE 20: 50% RH	B
<b>PID CONTROL PARAMETERS</b> for Heat and Cool Control Outputs. See Appendix I, "Control Parameter Tutorial," for detailed descriptions of control parameters.					
<i>DRSE</i>	2	Manual Reset	-100.0 to 100.0	0.0	D
<b>Proportional Bands #1 and #2</b> - In MENUs 3-6 you will select two proportional band settings for Heat PID Control and two settings for Cool PID Control. When configuring the 16 Ramp/Soak Programs on PAGES 1-16, you will specify which pair or proportional band settings to use (Heat PB #1 and Cool PB #1, or Heat PB #2 and Cool PB #2).					
<i>HPB1</i>	3	Heat Prop. Band #1	0.1 to 999.9% span	5.0	D
<i>HPB2</i>	4	Heat Prop. Band #2			
<i>CPB1</i>	5	Cool Prop. Band #1			
<i>CPB2</i>	6	Cool Prop. Band #2			
<i>HrSE</i>	7	Heat Automatic Reset (I)	0.00 to 99.99 repeats/minute	0.00	
<i>CrSE</i>	8	Cool Automatic Reset (I)			
<i>HrLE</i>	9	Heat Rate (D)	0 to 1000 seconds	0	
<i>CrLE</i>	10	Cool Rate (D)			
<i>HOF5</i>	11	Heat Offset (PID)	-25.00 to 25.00% of proportional band	0.00	
<i>COFS</i>	12	Cool Offset (PID)			
<i>LAPH</i>	13	Heat Overlap	0.0 to 1000.1% Prop. Band	0.0	
<i>LAPC</i>	14	Cool Overlap			
<i>HOLE</i>	15	Heat Output Limit	0.0 to 100.0% ON	100.0%	
<i>CLE</i>	16	Cool Output Limit			
<i>HCTP</i>	17	Heat Cycle Time*	0.1 to 65.0 seconds	4.0	
<i>CTCP</i>	18	Cool Cycle Time*			
*Cycle Time varies with the output type of your controller. Refer to Appendix I, Control Theory Tutorial for recommended Cycle Time settings.					
<b>ON/OFF CONTROL PARAMETERS</b> for both Heat and Cool Outputs. See Appendix I, "Control Theory Tutorial for detailed descriptions of control parameters.					
<i>HLOF</i>	19	Heat Offset (ON/OFF)	-25.00 to 25.00% of instrument sensor range	0.00	D
<i>CLOF</i>	20	Cool Offset			
<i>Hldb</i>	21	Heat Deadband	0.01 to 25.00% of instrument sensor range	0.01	
<i>CLdb</i>	22	Cool Deadband			
<b>CONTROL MODE SELECTION</b>					
<i>CTRL</i>	23	Control Modes	1 = Heat PID, Cool PID 2 = Heat PID, Cool ON/OFF 3 = Heat ON/OFF, Cool PID 4 = Heat ON/OFF, Cool ON/OFF	1 = Heat PID, Cool PID	D
<b>ALARM SET UP:</b> In MENU 24/25 you may establish up to 2 Alarm Set Points for each Channel (Channel 1 = PAGE 19, Channel 2 = PAGE 20), for a total of 4 Alarms.					
<i>R1SP</i>	24	Alarm #1 Set Point	Instrument Sensor Range	Sensor Range Maximum	
<i>R2SP</i>	25	Alarm #2 Set Point		Sensor Range Maximum	

**PAGE 19: CHANNEL #1 BIMODAL CONTROL AND ALARM PARAMETER**  
**PAGE 20: CHANNEL #2 BIMODAL CONTROL AND ALARM PARAMETERS**

CUE	MENU	SELECTION	AVAILABLE SETTINGS	FACTORY SETTING	SEC.
<i>A1LY</i>	26	Alarm #1 Type	0 = Disable 1 = High Alarm, NDE* 2 = Low Alarm, NDE 3 = + Deviation, NDE 4 = - Deviation, NDE 5 = +/- Deviation, NDE 6 = High Alarm, NE** 7 = Low Alarm, NE 8 = + Deviation, NE 9 = - Deviation, NE 10 = +/- Deviation, NE	0 = Disable	D
<i>A2LY</i>	27	Alarm #2 Type	NDE* = Normally de-energized, (contact closed on alarm) NE** = Normally energized, (contact open on alarm)	0 = Disable	
<i>A1db</i>	28	Alarm #1 Deadband	0.01 to 25.00% instrument sensor range	0.25	
<i>A2db</i>	29	Alarm #2 Deadband			
<i>A1on</i>	30	Alarm #1 ON Delay	0.1 to 999.9 seconds	0.1	
<i>A2on</i>	31	Alarm #2 ON Delay			
<i>A1oF</i>	32	Alarm #1 OFF Delay			
<i>A2oF</i>	33	Alarm #2 OFF Delay			
<p><b>ALARM RELAY ASSIGNMENT:</b> Since the Alarm requires use of at least one of the Event Outputs, here you select which Event Output will be used by the Alarm. Each Alarm may be assigned to a separate Event Output, or any combination of Alarms may be assigned to a single output to function as a common alarm. Simply enter the ON Code at the appropriate MENU for the Event Output to be used by each Alarm.</p>					
<i>A1rA</i>	34	Alarm #1 Output Relay Assignment	1 = Event Output 1 2 = Event Output 2 4 = Event Output 3 8 = Event Output 4 16 = Event Output 5 32 = Event Output 6 64 = Event Output 7 128 = Event Output 8	128 = Event Output 8	D
<i>A2rA</i>	35	Alarm #2 Output Relay Assignment		128 = Event Output 8	





# SECTION 5 EVENT AND ALARM OUTPUTS REMOTE RAMP/SOAK OPERATION INPUTS

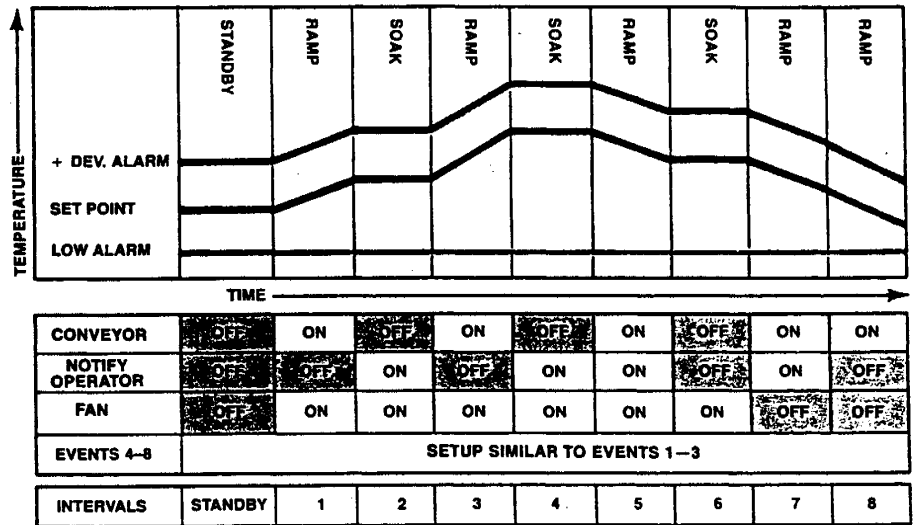
## EVENT OUTPUTS

One of the most versatile features of the 2030 controller is its capability to assign 4 Event Outputs to each Ramp/Soak Program, or as many as 8 if the additional Event Outputs were purchased. These additional Event Outputs are found in 2030 controllers with the following model numbers:

- 2030-\*\*5\*\*
- 2030-\*\*8\*\*

An Event Output is a 0.5 A (120 Vac) solid state relay output that may turn a peripheral device ON or OFF. These events might be to turn a fan on or off, to turn on a light or annunciator, to open a solenoid valve, or switch on a conveyor belt. How these Event Outputs might be used in a process is illustrated below.

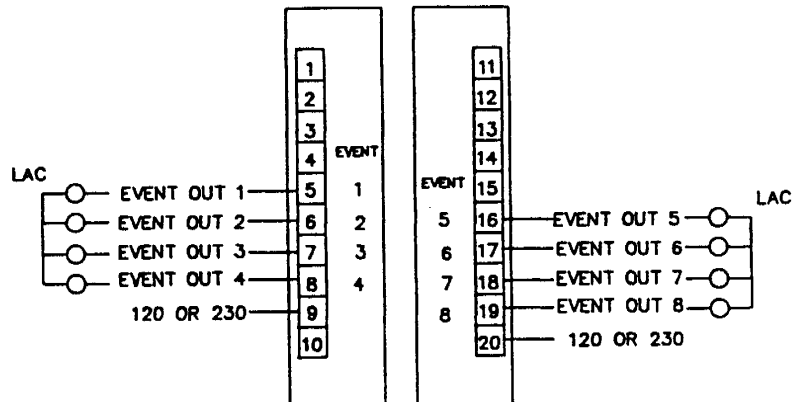
**Figure 5.1  
Event Outputs Applied  
in a Process**



## WIRING

The 4 standard Event Outputs (#5 - #8) are wired to the terminals 16 - 19, as shown below. The optional 4 Event Outputs (#1 - #4), if supplied, are wired to terminals 5-8.

**Figure 5.2  
Field Wiring for  
Event Outputs**



## Using Event Output Relays as Alarms

As described earlier in the PAGE/MENU Tables, PAGES 19-20, the Event Output Relays must be used if Alarm Relay Outputs are needed. This is accomplished by simply making the wiring connections to the Event Output(s) you choose to assign as the Alarm(s), following the Event Output Wiring Connections Figure 5.2. These Relays must also be selected in the programming, PAGE 19-20/MENU 34-35.

**An Event Output Relay cannot be assigned to be both an Event Output and an Alarm Output. The output relay can, however, be used as a common alarm output for any combination of the 4 alarm functions. If both an Alarm and an Event are assigned to the same relay, the Alarm will have priority over the Event and the relay will respond only to Alarm conditions.**

**When the relays are assigned as alarm outputs, the Event Output LEDs are disabled. For example, if Event Output #8 is assigned as an alarm, the Event #8 LED will not be illuminated when the alarm is activated.**

## What's Next?

As you saw in the previous diagram, each Event can be made to turn ON or OFF at the beginning of each of the 8 intervals. This is accomplished through programming.

## Programming the 8 Event Outputs

The Event Outputs for each Ramp/Soak Program are programmed in MENU Numbers 41 through 49 of their respective PAGES 1 through 16. This portion of the PAGE/MENU Table, presented earlier in Section 4, is repeated below:

CUE	MENU	SELECTION	AVAILABLE SETTINGS	FACTORY SETTING	SECURITY
EVENT OUTPUT SET UP: Detailed instructions for Event Output Set Up are given in Section 5 of this manual. Simply enter the sum of Event "ON" Codes at the MENU numbers corresponding to the Intervals. For example, to have Event Outputs 2, 6, and 7 turn on in Interval 3, set MENU 44 value to 2 + 32 + 64 = 98.					
		<u>Event Output #</u>	<u>ON Code</u>	<u>Event Output #</u>	<u>ON Code</u>
		1	1	5	16
		2	2	6	32
		3	4	7	64
		4	8	8	128
<i>5LEL</i>	41	Standby	0 to 255 (Any Sum of Event ON Codes)	0	D
<i>1LEL</i>	42	Interval 1		0	
<i>2LEL</i>	43	Interval 2		0	
<i>3LEL</i>	44	Interval 3		0	
<i>4LEL</i>	45	Interval 4		0	
<i>5LEL</i>	46	Interval 5		0	
<i>6LEL</i>	47	Interval 6		0	
<i>7LEL</i>	48	Interval 7		0	
<i>8LEL</i>	49	Interval 8		0	

Each of the Event Outputs #1 - #8 has an a different ON code, and an OFF code of "0". Simply add up the ON codes for the Events that should be ON during each interval, and enter that summed value at the appropriate MENU number.

<u>Event Output #</u>	<u>ON Code</u>
1	1
2	2
3	4
4	8
5	16
6	32
7	64
8	128

**Example:** Adjust Program 2.2, Interval 3 so that the following Events are ON -

- Event 1 - Indicator Light
- Event 3 - Conveyor Belt
- Event 4 - Vents Open
- Event 7 - Notify Operator

The ON codes for each of these Events are:

- Event 1 = 1
- Event 3 = 4
- Event 4 = 8
- Event 7 = 64

**TOTAL = 77**

Enter the value "77" at PAGE 6/MENU 44 (for Program 2.2, Interval 3).

Perform this procedure for all 8 Intervals, plus the Standby Interval, for each of your Ramp/Soak Programs to keep the Event on throughout the entire Ramp/Soak Program.

## REMOTE RAMP/SOAK OPERATION INPUTS

This feature, illustrated on page 1, Application #2, allows you to make the following Ramp/Soak operation selections remotely:

START/CONT  
HOLD  
STOP/RESET

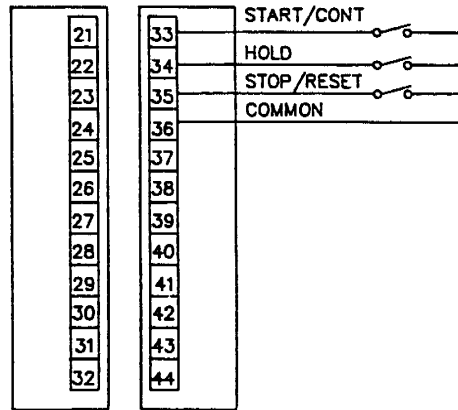
This feature requires that you connect relay contacts or the equivalent to the controller terminals, giving you the ability to make operation selections remotely from the remote selection device.

## WIRING

Make the connections to terminals 33-36 as shown in the wiring diagram Figure 5.3. These switches are 100 millisecond (minimum) momentary switches and are wired to the digital ground (terminal 36) and the input.

**NOTE:** If a switch action is to be repeated (i.e. START/CONT must be pressed 3 times to advance from Interval #1 to Interval #4), it must be ON for 100 ms, then OFF for 100 ms before being ON again. This information applies to situations where a PLC is commanding the switching action.

**Figure 5.3**  
**Field Wiring for**  
**Remote Ramp/Soak**  
**Operation Inputs**



**Programming**

No programming steps are required to enable the Remote Ramp/Soak Operation Input feature. Simply make the wiring connections and the remote operation capability is enabled.

## SECTION 6 ANALOG PROCESS OUTPUT OPTION

### Analog Process Output Option

The Analog Output Option is found only in controllers with the following model numbers:

2030-\*\*2\*\*

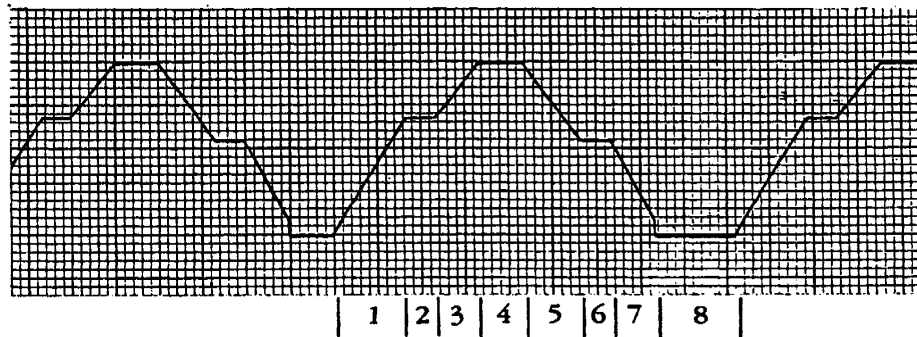
2030-\*\*8\*\*

This option can be used one of two ways:

1. To allow the Channel #1 or #2 process variable, the Channel #1 or #2 process set point, or the Channel #1 or #2 heat output command or cool output command to be transmitted to a remote recorder, computer or other device via a 4-20 mA or 1-5 Vdc analog signal.
2. To be reassigned as the Channel #1 or Channel #2 Output signal, supplying a 4-20 mA / 1-5Vdc output signal in place of the solid state relay outputs. This output signal could be used to drive a time proportional SCR firing package for control of a load larger than could be driven with the standard relay output.

The 4-20 mA / 1-5Vdc analog signal follows a linear curve and is factory calibrated over the entire instrument sensor range.

The following is a sample of a chart recording of the process variable, generated using the Analog Signal Output Option. Notice the 8 different intervals.

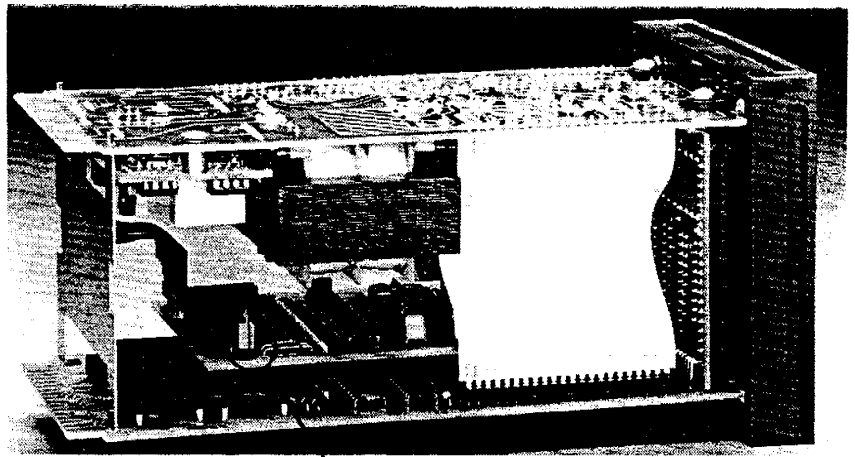


### Output Signal Selection

The 4-20 mA output signal can be changed to a 1-5 Vdc output signal by moving an internal jumper on the process output circuit card. The jumper is in the 4-20mA position when shipped from the factory. To change the analog output to a 1-5 Vdc signal:

1. Remove instrument power from the controller.
2. Remove the 2030 chassis from the instrument case (see page 5).
3. Locate the process output circuit card inside the controller chassis, as shown in Figure 6.1.

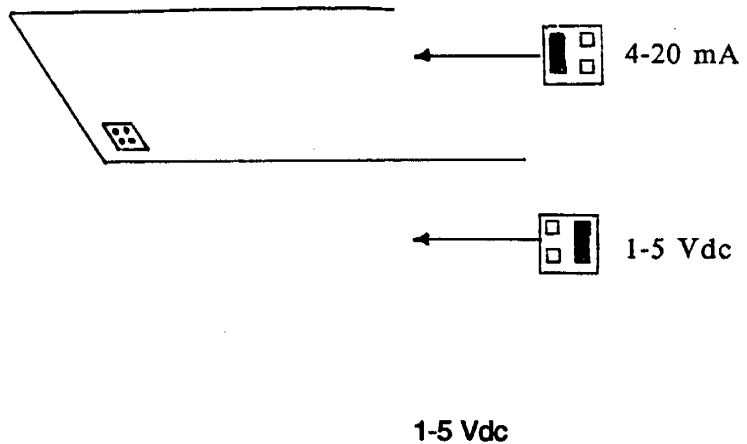
**Figure 6.1**  
**Locating the Process Analog**  
**Output Circuit Card**



Analog Process Output  
 Circuit Card Jumper

4. Reposition the jumper as shown in diagram below.
5. Place the controller chassis back in the case and proceed to Wiring.

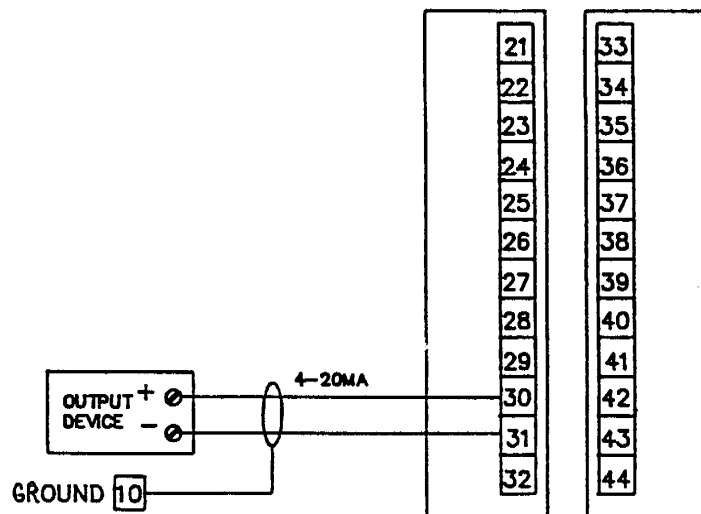
**Figure 6.2**  
**Jumper Positioning for**  
**Analog Process Output**  
**Signal Selection**



**WIRING**

Make the wiring connections for the Analog Process Output as shown in Figure 6.3.

**Figure 6.3**  
**Field Wiring for Analog**  
**Process Output**



**PROGRAMMING**

The Analog Process Output option is enabled and defined via PAGE 18/MENU 9, as indicated previously in the PAGE/MENU Tables. Make the appropriate settings in that portion of the PAGE/MENU Table repeated below.

PAGE 18: GENERAL OPERATION <i>GOP</i>					
CUE	MENU	SELECTION	AVAILABLE SETTINGS	FACTORY SETTING	SECURITY
<i>BP</i>	8	Barometric Pressure	0 to 99.99 inches of Mercury	29.92 inches	D
ANALOG OUTPUT ASSIGNMENT: In MENU 9 you may select the value that will be assigned to the 4-20 mA/1-5Vdc Analog Output. For more information on application of the Analog Output, see Section 6 of this Manual.					
<i>Output</i>	9	Process Analog Output Assignment	0 = Analog Output Disabled 1 = Channel #1 Heat Control Output 2 = Channel #1 Cool Control Output 3 = Channel #2 Heat Control Output 4 = Channel #2 Cool Control Output 6 = Channel #1 Process Variable 6 = Channel #2 Process Variable 7 = Channel #1 Set Point 8 = Channel #2 Set Point	6 = Channel #2 Process Variable	





## SECTION 7 DIGITAL COMMUNICATIONS

---

The Digital Communications option gives the 2030 controller the ability to interface with computers, dumb terminals, printers and recorders. This option is found on 2030 controllers with the following model numbers:

2030-**\*\*5\*\***  
2030-**\*\*8\*\***

When this option is present, it may be used in one of several modes: the ASCII terminal mode, computer interface mode, or automatic data logging mode. The mode that you choose is selected in the Digital Communications programming, PAGE 21.

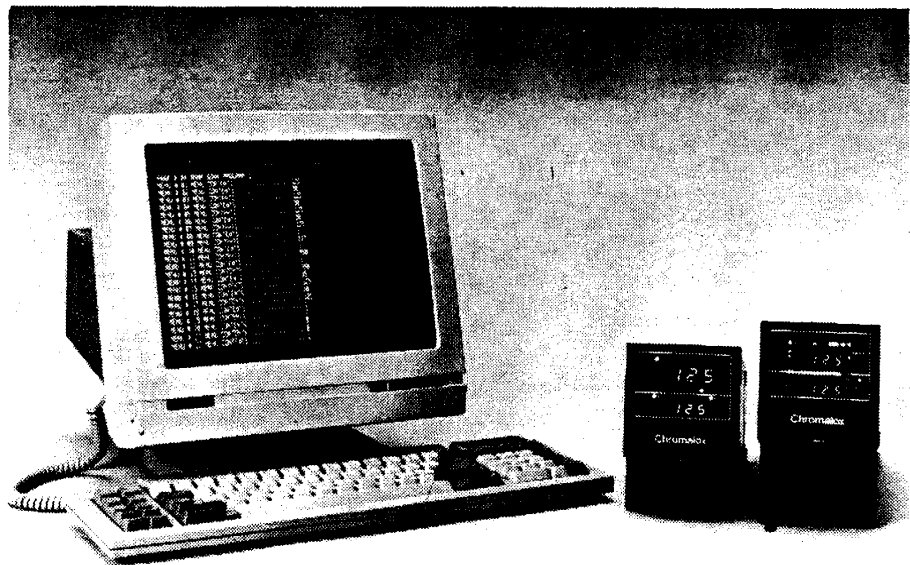
This section of the manual presents all wiring and connection information for the Digital Communications interface. **All programming and operation information is presented in the Digital Communications Operation and Programming Supplement**, a separate document that is included with the controller if you have purchased the Digital Communications option.

### TERMINAL/COMPUTER INTERFACE MODE

The ASCII terminal interface mode allows you to change PAGE/MENU settings, view them, and even lock out the controller front panel pushbutton selections. Because all of the software for this function is internally stored in the 2030 controller, nothing more than an ASCII dumb terminal is required.

Figure 7.1 illustrates a 2030 controller connected to a WYSE WY-60\* ASCII terminal. Notice that no computer or software is required for this interface.

**Figure 7.1**  
**2030 Controller with**  
**Dumb Terminal Digital**  
**Communications Interface**

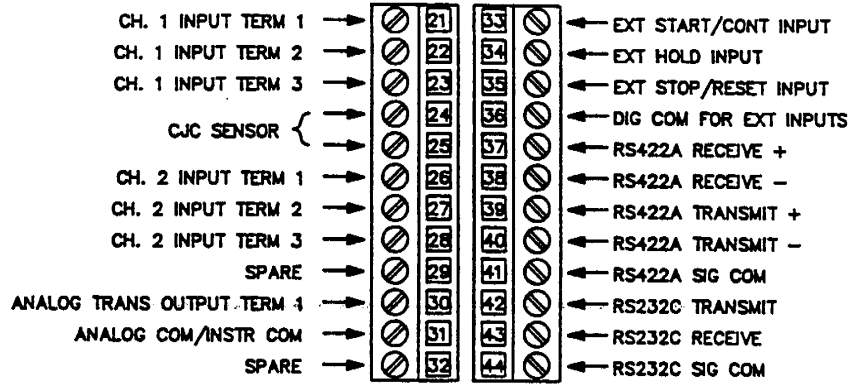


\*Registered trademark of WYSE Corporation.

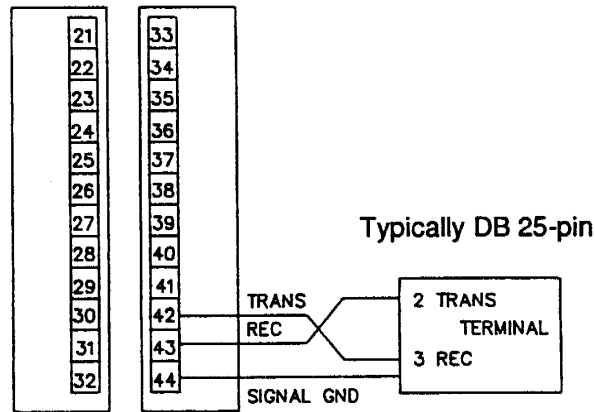
## WIRING AND TERMINAL CONNECTIONS

Wiring connections for the dumb terminal or computer interface are made as shown in the following wiring diagrams.

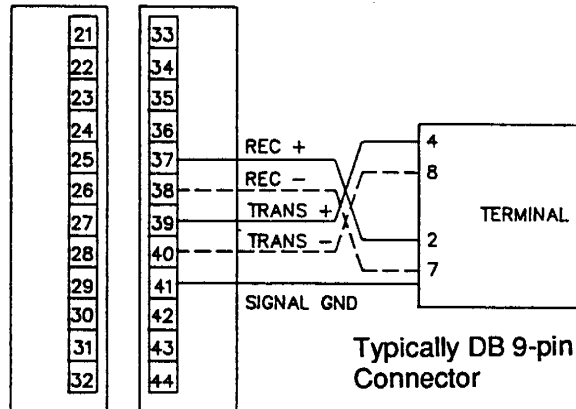
**Figure 7.2**  
2030 Controller  
Terminal Designations



**Figure 7.3**  
Field Wiring for RS232  
Digital Communications

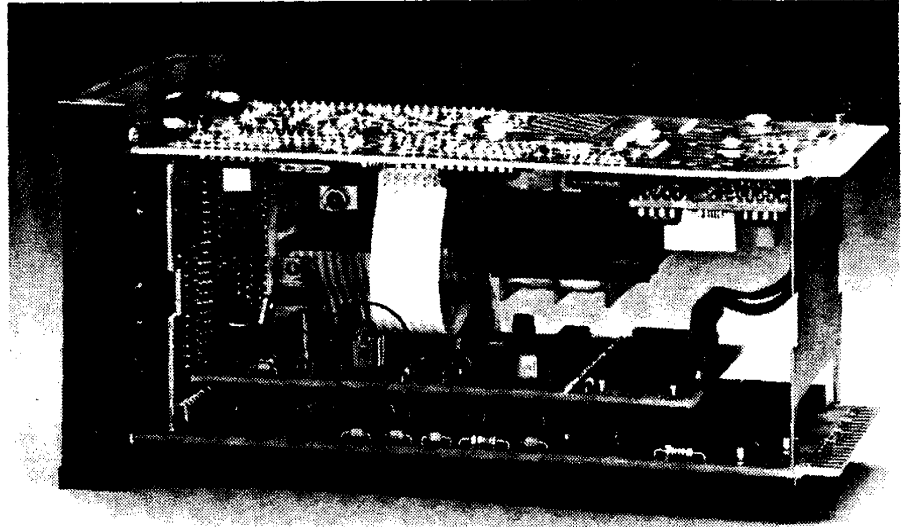


**Figure 7.4**  
Field Wiring for RS422  
Digital Communications

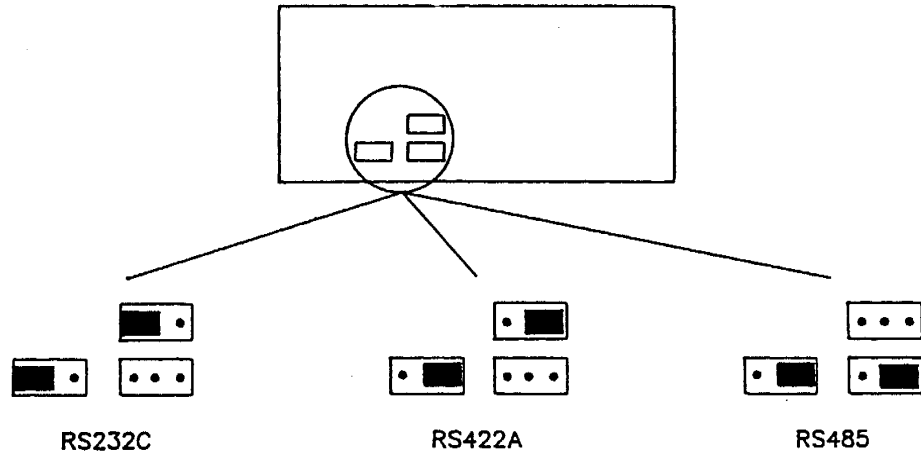


Two jumper moves are required to complete RS422A wiring. Remove the controller chassis from its case, locate the Digital Communications circuit card (see Figure 7.5), and move the jumpers as shown below to the RS422A positions.

**Figure 7.5**  
Digital Communications  
Circuit Card



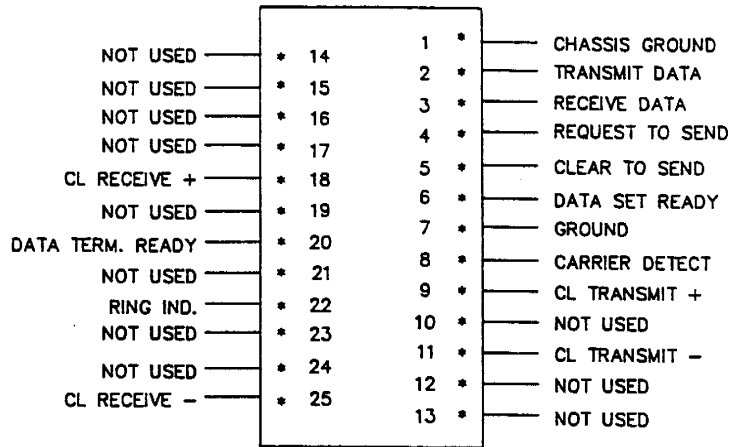
**Figure 7.6**  
RS422A Jumper Positions



**Terminal  
Connections**

If the terminal or computer which you are interfacing with uses a DB25 25-pin connector for its RS 232 interface , you will need a shielded serial interface cable fitted with a male 25-pin connector (DB-25) on the terminal end. Standard Connector pin assignments are given in Figure 7.7.

**Figure 7.7**  
**Standard Connector Pin**  
**Assignments**



Now that the serial interface connection is complete, plug the DB-25 connector into the **MODEM** or **COMM** port on your terminal. Be sure that the terminal is turned off before you connect the controller.

**AUTOMATIC DATA LOGGING**  
**MODE**

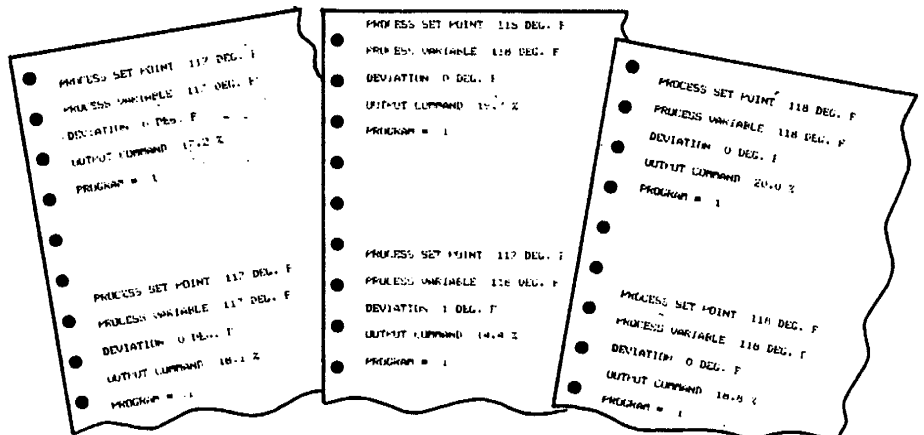
The Automatic Data Logging option is designed to provide a record or print out of selected MENU variables. The data logging function works with a simple printer or a ASCII dumb terminal.

The Automatic Data Logging print out on the following page was generated with an RS232 input printer. The MENU variables were selected from PAGE 0, with MENU 1 as the first MENU to log, and MENU 6 as the end MENU to log:

- MENU 1 = Channel #1 Process Set Point
- MENU 2 = Channel #2 Process Set Point
- MENU 3 = Channel #1 Deviation from Set Point
- MENU 4 = Channel #2 Deviation from Set Point
- MENU 5 = Program #
- MENU 6 = Interval #

You may select as few as 1 MENU number to log, or as many as all 11 MENU numbers.

**Figure 7.8**  
**Automatic Data Logging**  
**Sample Print Out**



## **PROGRAMMING AND OPERATION**

All programming and operation information is presented in a separate document entitled Digital Communications Operation and Programming. This supplement is included in the same shipment in which you received your controller and this manual, provided you have purchased a controller with the Digital Communications option.



## SECTION 8 CALIBRATION

---

### When Is Calibration Required?

The 2030 controller is factory calibrated before shipment to you, therefore, it is not necessary to calibrate the controller when you receive and install it. Periodic calibration checks or adjustments of the unit should not be required under normal operating conditions. Chromalox recommends that you recalibrate the controller in the following instances:

- \*new input cards are installed
- \*all instruments in your facility are periodically calibrated to one device (metrology)
- \*a measurement system component fails

### QUICK STEP and Manual Calibration

All calibration procedures are performed on **PAGE 22**. A simple "QUICK STEP" calibration of the full range sensor input is performed via MENU 1-3. MENU 4-23 are provided for manual calibration of sensor input and process analog output in applications where the process requires extreme fine tuning over a limited range, or where an "artificial offset" from actual process temperature is desired.

### Important Calibration Notes

1. **Disconnect load power when calibrating.**
2. RTD and Current/Voltage inputs should be calibrated using copper (Cu) wire, and thermocouple inputs should be calibrated using thermocouple extension wire (of the same type as the thermocouple you are calibrating). Thermocouples can be calibrated using copper wire, but the calibration procedure is more complex. For cold junction temperature calibration on copper wire, the temperature of the connection terminal must be measured instead of the ambient temperature. Also, equivalent microvolt values are used for span minimum and maximum instead of temperature values in °F.
3. Substitute a precision sensor simulator (thermocouple simulator or resistance decade box) for the sensor inputs. The controller should be allowed to warm-up with the appropriate sensor simulator connected for at least one hour prior to calibration.
4. To access the calibration **PAGE 22**, you will need to be at **LEVEL F Security**. Enter Security Code "736" at **PAGE 18/MENU 1**.

### QUICK STEP Calibration

To perform QUICK STEP calibration, you must first select the QUICK STEP calibration procedure code for your sensor type and the type of wire (T/C extension or copper) from the Calibration Procedure Code Table below. This code will "tell" the 2030 what sensor type you are using and the calibration range.



**Figure 8.1**  
**QUICK STEP Calibration Procedure Codes**

Sensor Type	Wire Type	Code
Cold Junction Comp. based on temp. entered in MENU 1		1
Channel #1, T Thermocouple	T/C Extension	2
Channel #1, T Thermocouple	Copper	3
Channel #1, RTD (High)*	Copper	4
Channel #1, RTD (Low)**	Copper	5
Channel #1, 4-20 mA/1-5 Vdc	Copper	6
Channel #2, T Thermocouple	T/C Extension	7
Channel #2, T Thermocouple	Copper	8
Channel #2, RTD (High)*	Copper	9
Channel #2, RTD (Low)**	Copper	10
Channel #2, 4-20 mA/1-5 Vdc	Copper	11

\*High Range RTD, -110.0 to 425.0°F

\*\*Low Range RTD, 32.0 to 212.0°F

QUICK STEP calibration is performed via MENU numbers 1,2, and 3, as shown in the PAGE/MENU table below.

PAGE 22: CALIBRATION					
CUE	MENU	SELECTION	AVAILABLE SETTINGS	FACTORY SETTING	SEC.
	1	Cold Junction Temp. at time of calibration	0.0 to 150.0°F (must enter in °F)	77.0°F	E
	2	Quick Step Calibration	QUICK STEP Calibration Codes (above Figure 8.1)	1 = Calibrate Cold Junction	
	3	Procedure Steps	0 = Start 1 = $\frac{1}{2}$ 2 = $\frac{1}{1}$ 3 = $\frac{1}{0.01}$	0 = Start	

**Instructions  
for Cold Junction  
Compensation  
Calibration**

1. Enter the controller terminal temperature in MENU 1 (for calibration with copper wire) or ambient temperature (for calibration with thermocouple wire).
2. Enter a "1" (or select alphanumeric label) in MENU 2 to calibrate the cold junction compensation offset based on the temperature entered in menu #1.
3. Enter a "1" in MENU 3. The upper display will indicate "---". The lower display will automatically increment to "3", indicating that the cold junction compensation procedure is complete.

## Instructions for Sensor Input Calibration

1. Enter the Calibration Procedure Code (obtained earlier in Figure 8.1, p.64) at MENU 2. For example, if you are using a type T thermocouple with thermocouple extension wire for Channel #2, enter a "7."
2. Set the sensor simulator to the minimum range value for the sensor (sensor "zero") and wait 30 seconds for the electronics to stabilize. Sensor ranges are given in Figure 1.2 on page 2.
3. Enter "1" at MENU 3 and wait until the dashes in the upper display disappear, indicating that Step 1 of the calibration is complete.
4. Set the sensor simulator to the maximum range value for the sensor (sensor "span"). Wait 30 seconds for the electronics to stabilize.
5. Enter "2" at MENU 3 and wait until the dashes in the upper display disappear and the value in the lower display automatically increments to 3, "lo, hi, done", indicating that calibration is complete.
6. Do not change the MENU 3 value after calibration is complete or the controller will continue to calibrate. Return to the MENU mode (by pressing the MENU/VAL pushbutton) and exit the PAGE.

## MANUAL CALIBRATION

Manual calibration may be performed when your application requires calibration over a limited range or an offset from actual process input, or to calibrate the Analog Process Output/Ramp Profile Output.

Manual calibration is very much like manual trimmer pot adjustments of other instruments, except that a "pot" is not turned. Instead of turning a "pot", the sensor input value, which is displayed in the upper digital display, is adjusted with the ^ and V pushbuttons until the sensor input value and the displayed value are equal. For each sensor type there are 2 corresponding MENU numbers - one for zero and one for span. It is usually necessary to repeat the zero and span calibration adjustments several times until the displayed values equal their respective input values.

The PAGE/MENU table gives the MENU numbers and sensor ranges for all sensor input types, as well as the Analog Process Signal Output.

## Sensor Input Manual Calibration Instructions

In these instructions, assume that a T thermocouple input is used for Channel #2. From the PAGE/MENU table, you can see that MENU 14 is for zero calibration and MENU 15 is for span calibration.

1. Access PAGE 22/MENU 14 and select the value to be displayed in the lower display by pressing MENU/VAL. The "VAL" LED will light.
2. Set the sensor simulator to the zero calibration value of -150°F.\* Wait 30 seconds to allow the electronics to stabilize.

3. Press the ^ or V pushbutton until the upper display value equals the sensor input value.\* (The lower digital display will display a calculated hexadecimal number that corresponds to the sensor input value.)
4. Access PAGE 22/MENU 15 and select the value to be displayed in the lower display by pressing MENU/VAL. The "VAL" LED will light.
5. Set the sensor simulator to the span calibration value of 500°F. Wait 30 seconds to allow the electronics to stabilize.
6. Press ^ or V until the upper display equals the sensor input value.
7. Repeat steps 1-6 until both values equal their respective sensor input values.

\*When performing manual calibration on an RTD input, the equivalent resistance value (ohms) should be used for the zero and span values.

\*\*For voltage/current input calibration, the displayed values are expressed in 0 to 100% of span.

### **Analog Output Manual Calibration Instructions**

The 2030's Analog Process Output cannot be calibrated automatically. Instructions for manual calibration follow:

1. Access PAGE 18/MENU 2 and enter the value "0". This disables ramp/soak programs and enables the use of PAGE 19/MENU 1 (single set point operation) as process set point.
2. Access PAGE 18/MENU 9 and enter the value "7". This assigns the analog output to represent the ramp/soak set point.
3. Connect the appropriate meter (current or voltage) to measure the analog output.
4. Access PAGE 19/MENU 1 and adjust the value to its minimum possible setting for the sensor type selected on PAGE 15/MENU 4-5.
6. Access PAGE 22/MENU 22 and adjust the value, until the output equals 4 mA or 1 Vdc.
7. Access PAGE 19/MENU 1 and adjust the value to its maximum possible setting for the sensor selected on PAGE 18/MENU 4-5.
8. Access PAGE 22/MENU 23 and adjust the value until the output equals 20 mA or 5Vdc.
9. The analog output calibration is complete. Return all PAGE/MENU settings (other than those on PAGE 22) back to their original values before returning the unit to operation.

**PAGE 22: MANUAL CALIBRATION**

<b>CUE</b>	<b>MENU</b>	<b>SELECTION</b>	<b>AVAILABLE SETTINGS</b>	<b>SECURITY</b>
	4 5	Cold Junction Zero Cold Junction Span	-32768 to 32767	E
	6 7	Channel #1, T T/C Zero Channel #1, T T/C Span		
	8 9	Channel #1, RTD (High) Zero Channel #1, RTD (High) Span		
	10 11	Channel #1, RTD (Low) Zero Channel #1, RTD (Low) Span		
	12 13	Channel #1, 4-20 mA/1-5 Vdc Zero Channel #1, 4-20 mA/1-5Vdc Span		
	14 15	Channel #2, T T/C Zero Channel #2, T T/C Span		
	16 17	Channel #2, RTD (High) Zero Channel #2, RTD (High) Span		
	18 19	Channel #2, RTD (Low) Zero Channel #2, RTD (Low) Span		
	20 21	Channel #2, 4-20 mA/1-5Vdc Zero Channel #2, 4-20 mA/1-5Vdc Span		
	22 23	Analog Process Output Zero Analog Process Output Span		



## SECTION 9 SPECIFICATIONS

---

### Control Modes (Field Selectable)

ON/OFF  
 Proportional (P)  
 Proportional with automatic reset/integral  
 and/or rate/derivative (PID, PI, PD)  
 Selectable for each Channel, both Outputs

### RAMP/SOAK SELECTIONS

#### 128 Intervals

16 programs, 8 intervals per program

#### Selectable Time Ranges

1-9999 seconds  
 0.1 to 999.9 minutes  
 0.01-99.99 hours

#### Linking

Programs can be linked together

#### Interval Loops

3 assignable loops per program  
 1-9999 or continuous run for each loop

#### Nested Program Loops

Total of 4 Program Loops

#### Automatic Hold

Programmable for each interval

#### Guaranteed Soak

Programmable for each program  
 Deadband of 0.01 to 99.99% of instrument sensor  
 range

#### Event Outputs

8 optional field assignable event outputs

#### Ramp/Soak Function Inputs

3 contact closures to digital ground for  
 remote selection of START/CONTINUE, STOP/RESET,  
 and HOLD

### CONTROL ADJUSTMENTS (Field Selectable)

#### Control Set Point

0 to 100% of span (°F, °C or %)

#### Deadband

0.01 to 25.00% of instrument sensor range

#### Proportional Bands\* (Gain)

0.1 to 999.9% of span, adjust for minimum and  
 maximum

#### Manual Reset

-100.0 to 100.0

#### Automatic Reset\*

0.00 to 99.99 repeats per minute

#### Rate\*

0 to 1000 seconds

#### Offset\*

-25.00% to 25.00% of proportional band

#### Overlap\*

0.0 to 1000.1% of proportional band

#### Output Cycle Time\*

0.1 to 65.0 seconds

\*Indicates separate control adjustments for Heat and Cool Outputs

## CONTROL OUTPUTS (Field Changeable)

### Solid State Relay

Normally-open solid state relay contact rated 0.5 amps at 120 Vac (resistive load). Not recommended for driving unsnubbed contactors.

## EVENT OUTPUTS

### Output Type

Normally-open solid state relay contact rated 0.5 A at 120 Vac

### Assignment

May be assigned to provide alarm relay action. Programmed to be ON or OFF during Intervals 1-8 and Standby

## ALARM OUTPUTS

4 Alarm Functions, 2 per Channel

### Relays

Event Output relays (0.5 A at 120Vac) may be used as alarm relays. One Event Output can be used as a common alarm output for any combination of the 4 Alarms.

## ALARM MODES (Field Selectable)

Normally energized or de-energized:  
High, range 100% of span, non-latching

Low, range 100% of span, non-latching

+ Deviation, 0 to 250°F above control set point, non-latching

-Deviation, 0 to 250°F below control set point, non-latching

+/- Deviation, 0-250°F above/below control set point, non-latching

### Reset Differential

0.01 to 25.00% of span

### ON Time Delay

0.1 to 999.9 seconds

### OFF Time Delay

0.1 to 999.9 seconds

## INPUT SELECTIONS

### Thermocouple

Type T, Copper/Constantan, non-isolated, -150 to 500°F (-101 to 260°C)

### RTD

100 ohm platinum, alpha=0.003926 DIN standard, three-wire recommended  
Available for High Range -110.0 to 425.0°F (-78.9 to 218.3°C), or Low Range 32.0 to 212.0°F (0.0 to 100.0°C)

### Current/Voltage

4-20 mA/1-5 Vdc, non-isolated, 0.0% to 100.0%  
250 ohms input impedance

## INPUT SAMPLE RATE

4 samples per second

<b>READOUT ACCURACY</b>	
Type T Thermocouple	+/- 1°F (less than 1°C)
100 Ohm Platinum RTD (High Range)	+/- 0.5°F (0.25°C)
100 Ohm Platinum RTD (Low Range)	+/- 0.2°F (0.1°C)
Current/Voltage	+/- 0.2%
Readout Stability	Typically better than 0.05°F (T T/C and RTD) and 0.1% (Current/Voltage) per 1°F change in ambient temperature
<b>OPEN SENSOR CONDITION</b>	
Control Output	Off
Display Indication	"OPEN"
<b>OUT OF RANGE CONDITION</b>	
Control Output	Off
Display Indication	"HHHH" for over-range condition "LLLL" for under-range condition
<b>PROCESS ANALOG OUTPUT OPTION</b>	
Assignable Functions	Heat or Cool Output Commands, Primary Set Point, or Linearized Process Variable Signal for both Channels #1 and #2 (field selectable)
Output Signal	4-20 mA standard, conversion to 1-5 Vdc voltage by internal jumper change. 4-20 mA signal referenced to instrument common
Accuracy	+/- 0.2% of span
<b>DIGITAL COMMUNICATIONS OPTION</b>	
RS232C/RS422A	Single drop, non-isolated or isolated
Automatic Logging Interval	1 to 9999 minutes
Baud Rate	300, 600, 1200, 2400, 4800, 9600, 19200
Data String (Single Drop)	ASCII, Asynchronous, one start, one parity, seven data and one stop bit



## INSTRUMENT POWER

120 Vac, -15% to +10%, 50-60 Hz.  
Nominal power consumption 10 VA.  
Power failure detection circuitry, hardware watchdog timers with restart capability.

## OPERATING ENVIRONMENT

30 to 130°F (0 to 55°C) ambient temperature  
with relative humidity less than 95%, non-  
condensing

## DIMENSIONS

<b>Panel Cutout</b>	3.6 x 3.6 inches (52mm x 52mm), per DIN 43700
<b>Depth Behind Panel</b>	8.6 inches (200mm)
<b>Front Panel Projection</b>	0.8 inches (25mm)

## INFLUENCE OF LINE VOLTAGE VARIATION

<b>Thermocouple/RTD</b>	+/-0.25°F maximum change in readout for +10%, -15% nominal line voltage
<b>Voltage/Current</b>	+/-0.1% maximum change in readout for +10%, -15% nominal line voltage

## NOISE REJECTION

<b>Common Mode</b>	Less than +/- 2°F (1°C) with 230 Vac, 60 Hz applied from sensor input to instrument case (with digital filter enabled)
<b>Series Mode</b>	Less than +/- 2°F (1°C) with 300 mV peak to peak, 60 Hz series mode noise (with digital filter enabled)
<b>Radio-Frequency</b>	Typically less than 0.5% of set point span at distance of 1 m from transmitter (4W at 464 MHz)

# SECTION 10 ERROR CODES AND TROUBLESHOOTING

## Troubleshooting

The following Troubleshooting Guide gives simple solutions to common problems. Should you have a problem with your controller, it is a good idea to check this Guide for possible corrections.

SYMPTOM	PROBABLE CAUSE	CORRECTION
Power applied, display does not light and controller does not function	1. No power applied to controller 2. Power loss transient	Check power wiring and fusing Power down and re-power up
Display reads "HHHH" or "LLLL" HHHH LLLL OPEN	1. Open sensor  2. Out of calibration	Check sensor wiring (pages xx - xx) Check sensor type and selection entered on PAGE 18/MENU 4-5. Attach sensor simulator and verify calibration.
Process does not heat up/cool down	1. No power being applied to the load.  2. Heat output/cool output wired incorrectly.	Verify output wiring (pages xx - xx) Verify that load is not open - output module properly installed if changed in field. Check control mode entered PAGE 19-20/MENU 23.
Erratic Operation	1. Intermittent sensor connections.  2. Controller failure (internal)	Check sensor wiring or substitute sensor simulator. Power down and re-power up. Contact factory.
Process not in control	1. Heat/Cool output wired incorrectly 2. Not tuned correctly	Check wiring to heat/cool outputs. See "Tuning" in Appendix I to verify valid PID parameters entered on PAGE 19-20.
"Err1" appears in upper display <i>Err1</i>	1. RAM Error	Power down to clear. Return to factory if "Err1" does not clear on re-power up.
"Err2" appears in upper display <i>Err2</i>	1. ROM Checksum Error	Same as previous error.
"Err3" appears in upper display <i>Err3</i>	1. EEPROM failure	Display indicates the PAGE/MENU number where the failure has occurred. Reprogram the setting for that PAGE/MENU number.
"Err4" appears in upper display <i>Err4</i>	1. Calibration Error	Verify correct calibration parameters and recalibrate.



## APPENDIX I CONTROL THEORY TUTORIAL

---

This Tutorial contains detailed descriptions of specific control parameters, Ramp/Soak control functions and other selections made through the PAGE/MENU programming of the 2030 controller. The purpose of this Tutorial is to help you better understand the selections and settings you are making, thus increasing the applications effectiveness of your 2030 controller.

The list is alphabetized for quicker reference, and references to other definitions are made to help you understand the interrelationships of selections/parameters. Notice that "Proportional", "PID" and "ON/OFF" appear below some of the parameters, indicating that these parameters apply only to Proportional, PID or ON/OFF control.

### **Alarm Deadband** PAGE 19-20/ MENU 28-29

The Alarm Deadband, expressed in % of the instrument sensor range, determines at what point the alarm will go back to its normal (energized or de-energized state) state after having gone into alarm at set point. The factory setting for Alarm Deadband is 0.25% of instrument sensor range.

### **Alarm OFF Delay** PAGE 19-20/ MENU 32-33

This setting allows you to specify a "delay" time of 0.1 to 999.9 seconds before the Alarm "turns OFF" or resets to its normal (open or closed) state after the alarm condition no longer exists. For example, assume the low absolute alarm actuates at 200°F, and will reset at 210°F. If the OFF Delay time is set at 30.0 seconds, the alarm will not actually reset until the temperature has been at or above 210°F for 30.0 seconds. This feature will lengthen the time the unit allows for the operator to be notified of the alarm condition, and can eliminate "temporary" alarm resets due to brief process excursions to within acceptable ranges.

### **Alarm ON Delay** PAGE 19-20/ MENU 30-31

This setting allows you to specify a "delay" time of 0.1 to 999.9 seconds before the Alarm will "turn ON" or actuate an alarm when an alarm condition has been reached. Assume that the high absolute alarm actuates at 1150 F. If the ON Delay time is set at 120.0 seconds, the Alarm will not actuate until the process temperature has been at or above 1150 F for 120.0 seconds. The Alarm ON Delay is used to eliminate unwanted alarm action due to momentary process excursions beyond the alarm set point.

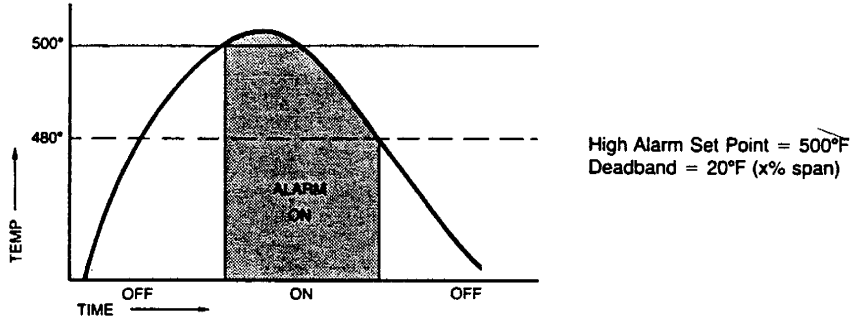
### **Alarm Set Point** PAGE 19-20/ MENU 24-25

The Alarm Set Point determines at what process variable the alarm will actuate. With High and Low absolute Alarms, the Alarm Set Point is constant. For example, if the High Alarm Set Point is 500 F, the Alarm will always actuate when the process temperature reaches or exceeds 500 F. With Deviation alarms, the Alarm Set Point determines at what point below or above the process set point the alarm will actuate, as illustrated under **Alarm Types**.

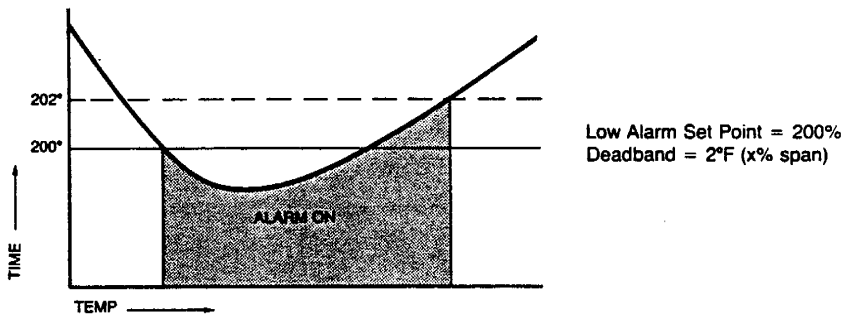
**Alarm Types**  
 PAGE 19-20/  
 MENU 26-27

There are 5 alarm types available on the 2020 controller.

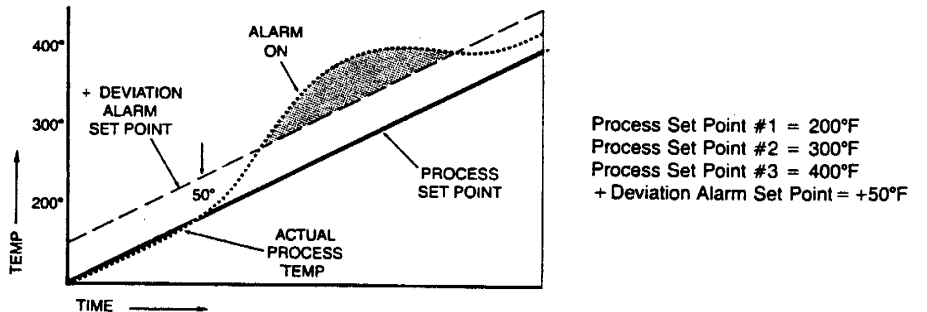
**High Alarm:** This alarm is a high absolute alarm that actuates when the process temperature is equal to or greater than the Alarm Set Point.



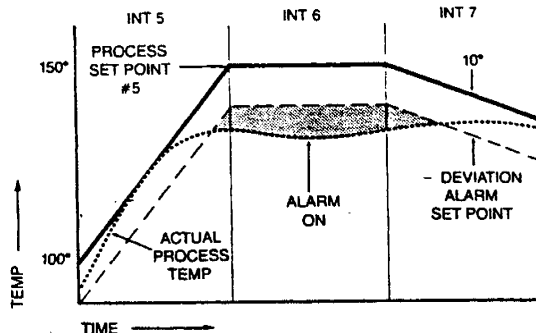
**Low Alarm:** The low absolute alarm actuates when the process temperature is equal to or less than the Alarm Set Point.



**+ Deviation Alarm:** This alarm actuates when the process temperature is equal to or greater than the Process Set Point plus the Alarm Set Point. When the Process Set Point is moved, the deviation alarm moves with it, maintaining the same deviation from set point.

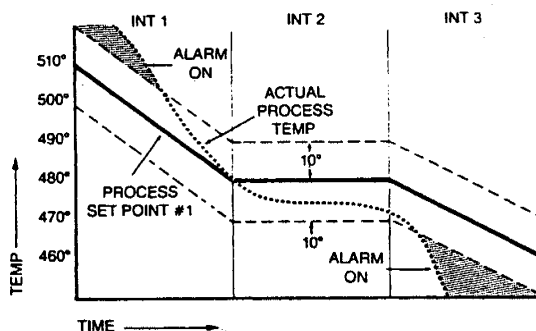


- **Deviation Alarm:** Similar to the deviation alarm described above, the - deviation alarm actuates when the process variable is equal to or less than the **Process Set Point less the Alarm Set Point**.



Process Set Point #5 = 150°F  
 Process Set Point #6 = 150°F  
 Process Set Point #7 = 135°F  
 - Deviation Alarm Set Point = -10°F

**+/- Deviation Alarm:** This deviation alarm is actuated whenever the process temperature deviates from the **Process Set Point** more than the **predetermined (Alarm Set Point)** amount in either a **positive or negative** direction.



Process Set Point #1 = 480°F  
 Process Set Point #2 = 480°F  
 Process Set Point #3 = 460°F  
 ± Deviation Alarm = 20°F

Each of these 5 alarm types may be chosen as **normally-energized (NE)** contacts, or **normally-deenergized (NDE)** contacts. For example, a normally-deenergized High Alarm will **close** when actuated (process temperature is equal to or greater than the Alarm set point).

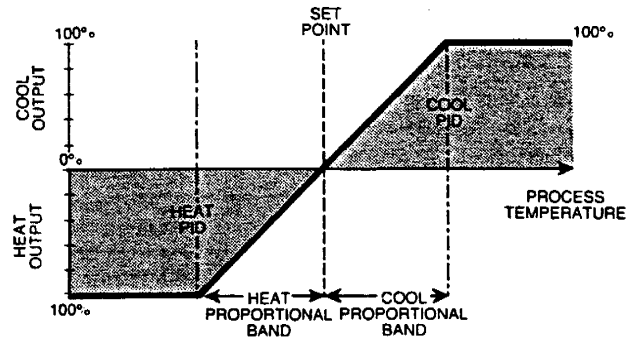
**Automatic Reset  
 PID  
 PAGE 19-20/MENU 7-8**

Automatic Reset (Integral) is expressed in repeats per minute. A value of 0.00 disables the Automatic Reset function and enables the Manual Reset function (PAGE 19-20/MENU 2). Adjustment of Automatic Reset should be made while the process is being controlled.

Automatic Reset is basically a control action that automatically eliminates offset between set point and process temperature. An Automatic Reset setting that is too large will cause severe overshoot during start-up if the controller is operating as a PI controller. Likewise, a setting that is too low will not allow the process temperature to return to set point quickly enough. An anti-reset windup feature is incorporated in the 2030 controller to minimize process overshoot by inhibiting the reset action during warm-up or cool-down.

**Bimodal Control**  
 PAGE 18/MENU 3  
 PAGE 19-20/MENU 23

A type of control with two outputs - for example, one for heating and one cooling, each output having individually adjustable PID or ON/OFF control modes.

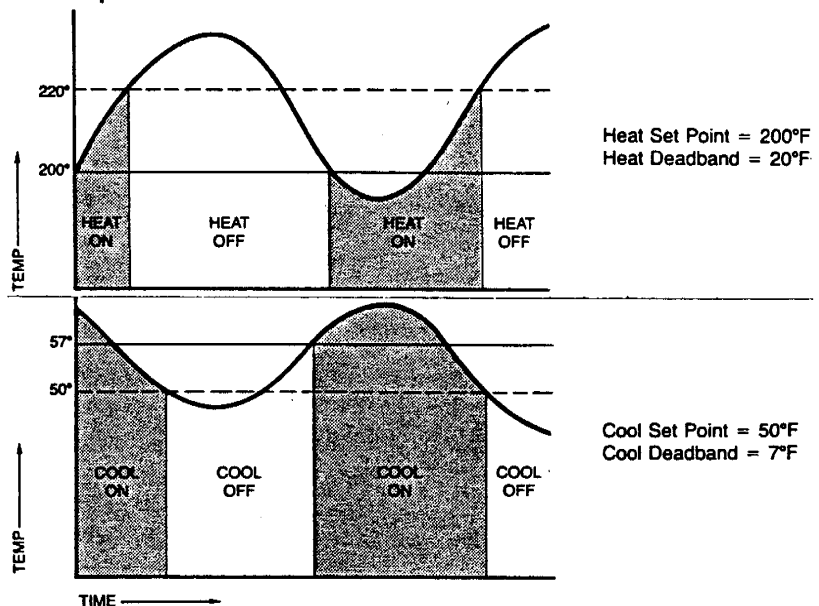


**Cycle Time Proportional/PID**  
 PAGE 19-20/  
 MENU 17-18

Cycle Time is the time it takes to complete a full ON to OFF to ON cycle in a time proportioning control system. For most processes, a fast cycle time (less than 5 seconds) will produce better control of loads with fast response and little time lag. You should be very careful when setting the cycle time on contactor driven loads, as a faster cycle time will cause added contactor wear. Magnetic contactors should not be switched at cycle times less than 30 seconds.

**Deadband ON/OFF**  
 PAGE 19-20/  
 MENU 21-22

In ON/OFF control, the deadband represents an area about set point in which no control action takes place, and determines at what temperature the Output switches ON and OFF.



Narrow deadband settings give more accurate control but result in more frequent output switching, which can cause early failure of electromechanical contactors.

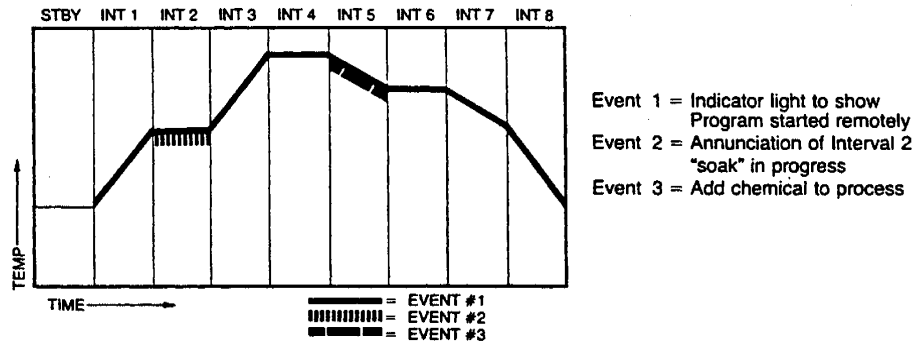
Dead band is adjustable from -25.00% to 25.00% of span, and is programmed separately for each of the two outputs, Heat and Cool, and applies only if the output is programmed as ON/OFF control on PAGE 19-20/MENU 23.

**Event Outputs**  
PAGE 1-16/  
MENU 41-49

Events Outputs are merely timed outputs which are either ON or OFF during an entire Ramp/Soak Program interval. There are 4 standard Event Outputs with each 2030 controller, and an additional 4 Optional Event Outputs, for a total of 8 Event Outputs (if purchased) available for assignment in each Ramp/Soak Program.

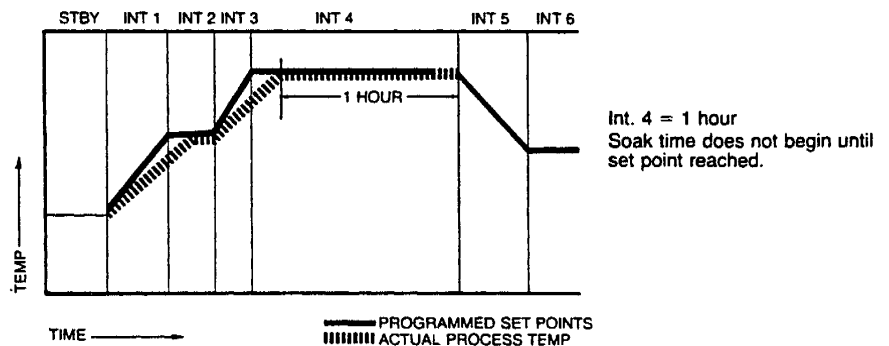
If an Event Output relay has been assigned as an Alarm Output on PAGE 19-20/MENU 34-35, it cannot be used as an Event Output.

The diagram below illustrates three Event Outputs in a Ramp/Soak Program. Notice that the Event will remain ON for the entire interval.



**Guaranteed Soak**  
PAGE 1-16/  
MENU 50-60

This Ramp/Soak feature, when enabled, assures that the "soaking" time in an interval does not begin until the process reaches set point or is within the Guaranteed Soak Differential band. Only when the process variable is within the Guaranteed Soak Differential will the interval time begin counting down. See Soak Interval and Guaranteed Soak Differential for more information.



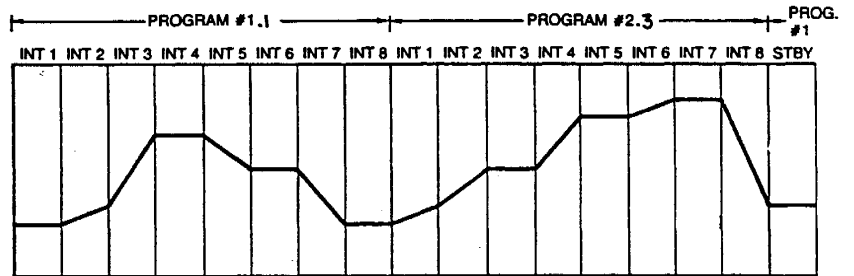


**Guaranteed Soak  
Differential  
PAGE 1-16/  
MENU 59-60**

The Guaranteed Soak Differential establishes a symmetrical +/- band around the process set point that insures that the interval soaking time does not begin until the process is within this band.

**Linking Programs  
PAGE 1-16/MENU 40**

This Ramp/Soak feature allows you to Link the end of a Program to the beginning of another Program, as illustrated below.



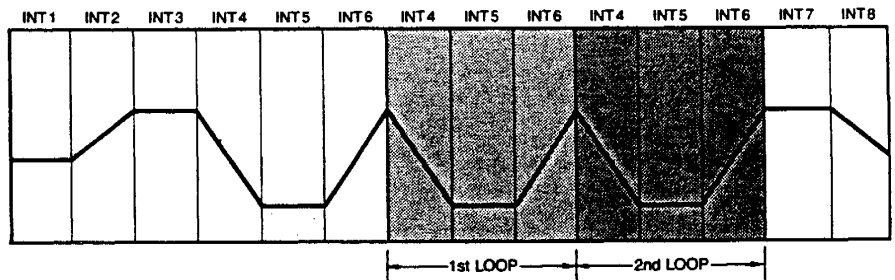
In this example, Program #1.1 is linked to Program #2.3. When Program #2.3 is completed, the process will go to the Standby interval of Program #1.1, since Program #1.1 is the Program selected on PAGE 18/MENU 2. The Program selected dictates the Standby interval that will be in effect when the linked program(s) is/are complete.

A Program can also be linked to itself, meaning that the Program would run continuously until stopped by the operator (press STOP/RESET), in which case it would then go to Standby.

**Looping Intervals  
PAGE 1-16/  
MENU 31-39**

The Ramp/Soak Looping feature allows you to establish up to 3 "loops" within a Program. Looping means that an interval or series of intervals within a Program may be repeated in a looping fashion. You simply specify: Loop the end of Interval \_\_\_ to the beginning of Interval \_\_\_ and repeat the loop \_\_\_ times.

An example of a single Loop within a Program is illustrated below:



If more than one Loop is programmed within a single Program, the Loops are prioritized, or "nested". Loop 1 has the highest priority, and Loop 3 has the lowest priority. A general rule of thumb is:

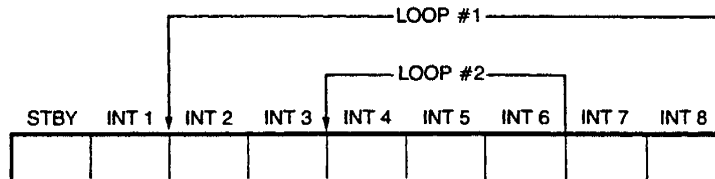
Each time Loop #1 runs, it resets all other Loop counters within Loop #1

Each time Loop #2 runs, it resets Loop #3  
Loops within Loop #2, but cannot reset Loop #1

Loop # 3 cannot reset any other Loop counters

Following are two different Loop configurations, illustrating this loop prioritization. The intervals and number of times each loop runs are the same, but the prioritization is different. Notice how differently the Program is executed in each example.

**Looping  
Example A:**



Loop #1 = Loop the end of Interval 8 to the beginning of Interval 2, 4 times.

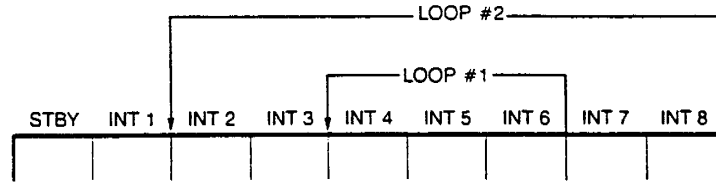
Loop #2 = Loop the end of Interval 6 to the beginning of Interval 4, 2 times.

Loop #1, looped outside of Loop #2, has highest priority.

**Operation**

- \*Loop #2 will run 2 times
- \*Loop #1 will run 1st time, resetting Loop #2 counter to 0
- \*Loop #2 will run 2 times
- \*Loop #1 will run 2nd time, resetting Loop #2 counter to 0
- \*Loop #2 will run 2 times
- \*Loop #1 will run 3rd time, resetting Loop #2 counter to 0
- \*Loop #2 will run 2 times
- \*Loop #1 will run 4th (final) time, resetting Loop #2 counter to 0
- \*Loop #2 will run 2 times
- \*Loop #1 has counted out (4 times) and will not run again
- \*Program goes to completion

Looping  
Example B:



Loop #1 = Loop the end of interval 6 to the beginning of interval 4, 2 times.

Loop #2 = Loop the end of interval 8 to the beginning of interval 2, 4 times.

Loop #1, looped inside of Loop #2, has the highest priority.

Operation

\*Loop #1 will run 2 consecutive times, counting out

\*Loop #2 will run 4 consecutive times, counting out (because Loop #1 has counted out, the Loops are not reinitiated)

\*Both Loops #1 and #2 counted out, so the program goes to completion.

**Manual Reset**  
**Proportional Control**  
PAGE 19-20/MENU 2

Manual reset applies to Proportional (P) control only. It compensates for deviations from set point resulting from sustained, long term process load changes. Manual reset allows adjustment of the control output in an amount sufficient to return the process variable to the process set point. Increasing the manual reset setting increases temperature, therefore, if the process temperature is stabilizing below set point, increase the manual reset.

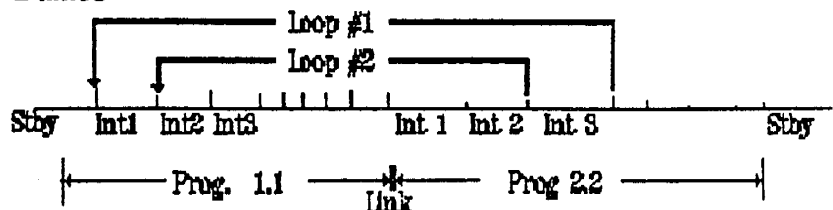
**Nested Program Loops**  
PAGE 17/MENU 1-20

These 4 Program Loops allow you to loop from any Program #/Interval # to any other Program #/Interval # up to 255 loops and continuously. Just like the Interval Loops, these loops are prioritized. The two examples below illustrate how Loop #1 has priority over Loop #2, etc.

**Nested Program Loops**  
Example A:

Loop #1 from the end of Prog. 2.2, Interval 3 to the beginning of Prog. 1.1, Interval 1  
2 times

Loop #2 from the end of Prog. 2.2, Interval 2 to the beginning of Prog. 1.1, Interval 2  
2 times



### Operation

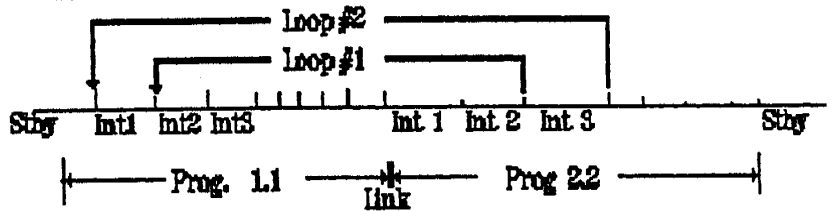
- \*Loop 2 runs 2 times
- \*Loop 1 runs 1st time, and resets Loop 2 counter to 0
- \*Loop 2 runs 2 times
- \*Loop 1 runs 2nd time (counted out), and resets Loop 2 counter to 0 again
- \*Loop 2 runs 2 times
- \*Both Loop counters counted out, Program continues.

### Program Loops

#### Example B:

Loop #1 from the end of Prog. 2.2, Interval 2 to the beginning of Prog. 1.1, Interval 2  
2 times

Loop #2 from the end of Prog. 2.2, Interval 3 to the beginning of Prog. 1.1., Interval 1  
2 times.



### Operation

- \*Loop #1 runs 2 times, counting out the counter.
- \*Loop #2 runs 2 times, counting out the counter.
- \*Both Loops counted out, Program continues.

### Offset

#### Proportional Control

PAGE 19-20/MENU 11-12

#### ON/OFF Control

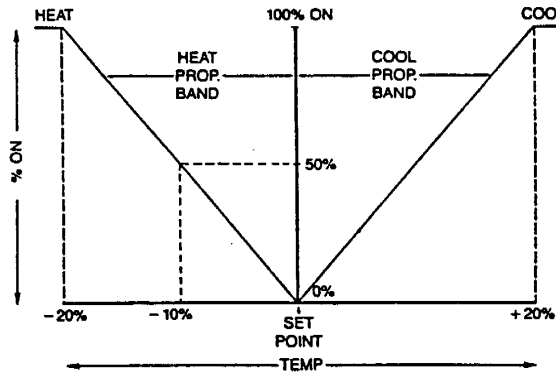
PAGE 19-20/MENU 19-20

Offset should be used in applications where it is undesirable to have simultaneous operation of heat and cool outputs or energization within a specified narrow range about set point.

The Offset adjustment creates a dead zone between set point and the point at which the Output is active. Offset may be adjusted for both the Heat output and Cool output.

Diagrams A, B, and C below illustrate the effects of various offset set ups. Figure A shows both the heat and cool proportional bands originating at the set point with 0.0% Offset. With zero error signal, neither the heat nor cool outputs will be on. If the error signal deviates in either the heat or cool direction, a corresponding output will occur.

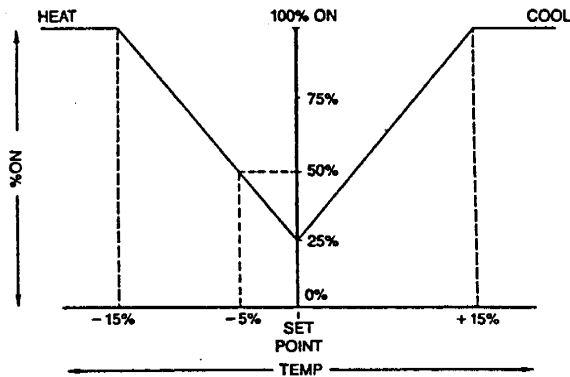
**Figure A**



Heat Prop. Band = 20.0%  
Cool Prop. Band = 20.0%  
No Offset  
No Overlap

Figure B shows both the heat and cool proportional bands offset or shifted by +25.0%. This shift in effect "mirrors" both proportional bands by 5%. If the error signal deviates in either the heat or cool direction, a corresponding minimum output of 25% occurs.

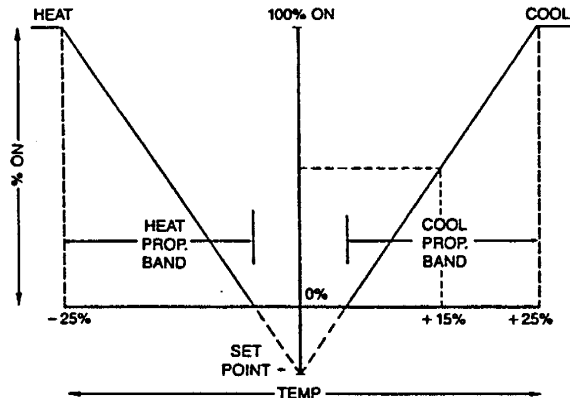
**Figure B**



Heat Prop. Band = 20.0%  
Cool Prop. Band = 20.0%  
Heat Offset = +25.0%  
Cool Offset = +25.0%

Figure C indicates the results of shifting the proportional band -25%. The proportional band remains constant at 20% for both heat and cool, but no control action occurs until the error signal has deviated 5% on either side of the setpoint.

**Figure C**



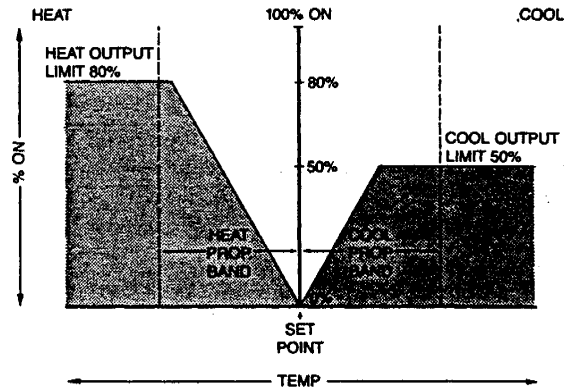
Heat Prop. Band = 20.0%  
Cool Prop. Band = 20.0%  
Heat Offset = -25.0%  
Cool Offset = -25.0%

**ON/OFF Control**  
PAGE 19-20/MENU 23

With ON/OFF control the temperature is controlled about the set point by turning the output 100% ON or 100% OFF at set point. ON/OFF control is recommended for loads that cannot tolerate rapid cycling, such as pumps air conditioning, etc. See Hysteresis and Offset for more information on ON/OFF control.

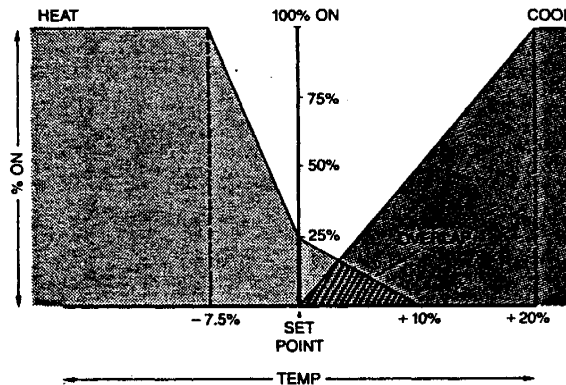
The PID output for the Heat and/or Cool outputs can be limited by the Output Limit setting. The purpose of Output Limit is to prevent dangerous over-heating (or over-cooling). This limit can be set from 0.0 to 100.0% of full ON.

If the limit is set at 80.0%, then a time-proportioned output would remain ON no longer than 80% of the time (a 4-20 mA output would never exceed 16.8 mA). A setting of 100% allows full output. The output limit does not operate in the ON/OFF modes.



The Overlap feature allows the two outputs (heat and cool) to be on at the same time. Figure D and E define two overlap conditions. In Figure D, the heat proportional band is offset by 25% and the cool proportional band is not offset. The heat overlap is set to 100% of the heat proportional band. This causes the heat output to remain on as well as the cool output. The heat output will decrease linearly from 25% ON to 0% ON in 10% of span.

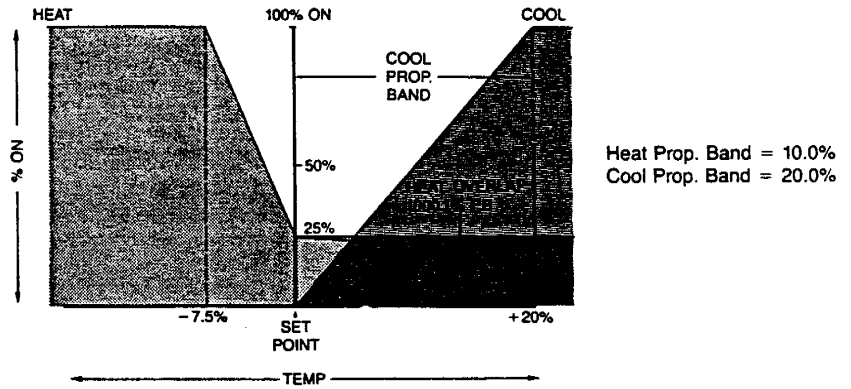
Figure D



No Offset or Overlap on Cool.  
 Heat Offset = 25.0%  
 Overlap = 100.0% Heat Prop. Band  
 Heat Prop. Band = 10.0%  
 Cool Prop. Band = 20.0%

Figure E illustrates two cases. The first case is with a heat overlap setting of 1000.0% of the heat proportional band. This results in the heat output changing from 25% to 0% in a band equivalent to 10 times the heat proportional band. In the illustration, the heat output has dropped to 20% at the 100% output point in the cool proportional band (slope of decrease = 5% ON per 20% proportional band). If the overlap had been set to 1000.1% the heat would have remained 25% ON across the entire cool proportional band.

Figure E



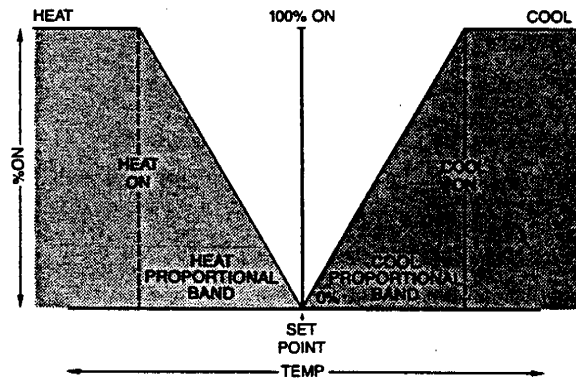
The display on the front of the controller can represent no more than 4 digists. If a display greater than 9999 is required, the display will change from a normal base ten number system to the hexadecimal number system. Following are two examples of hexadecimal numbers that may be displayed in the overlap settings:

Base Ten Number	Hexadecimal Number
10000	2710
10001	2711

**PID Control**  
PAGE 19-20/MENU 23

PID control is basic Proportional Control enhanced by Integral Control and Derivative Control. The Integral (I) part of PID control, or automatic reset, automatically eliminates offset between set point and actual process temperature due to long term load changes. Derivative, or rate, is an anticipatory action that allows the controller to react more quickly to sudden changes in the process temperature.

In the 2030 controller, both the Heat and Cool outputs can have independent PID settings, allowing for maximum flexibility of application. See PAGE 19-20/MENU 23 for control mode selection, and PAGE 18/MENU 3 for bimodal control selection.



**Proportional Band**  
**Proportional / PID**  
PAGE 19-20 /  
MENU 3-6

The Proportional Band is the temperature range about set point where the proportional control action is active from 0% to 100%. Most applications require a Proportional Band setting between 1.0 and 20.0% of temperature span.

The 2030 controller allows you to pre-establish two Proportional Band settings for each of the two outputs, Heat and Cool. This allows you to select the Proportional Band that provides the best control for different Ramp/Soak

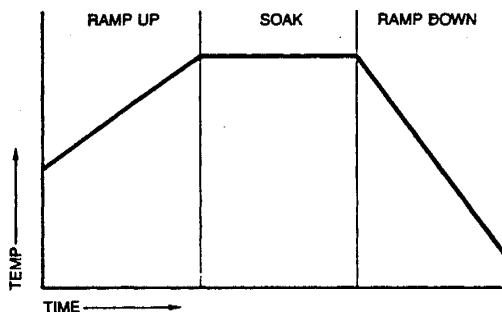
programs and processes, particularly when two totally different variables, such as temperature and humidity, are being controlled with the same controller. Since these processes have different gains, the two proportional band settings allow you to select the setting for each process that will deliver optimum process stability.

### Proportional Control

A type of control action that proportions its control output instead of merely turning it full ON or full OFF. See Proportional Band and Manual Reset for further information.

### Ramp Interval

An interval within a Ramp/Soak program in which the controller action takes the process from one set point to another set point within a specified amount of time.



### Rate PID PAGE 19-20/ MENU 9-10

Rate (derivative) allows the controller to react more quickly to sudden changes in process temperature. Rate measures the rate of change of the process temperature, anticipates its severity and makes output corrections to maintain a steady return to temperature. If the proportional band, reset and rate are not properly coordinated with the process' characteristics, the process loop may be unstable. Rate can also be used without automatic reset (integral) for PD control with manual reset.

Since Rate is an anticipatory action, it can actually override the cycle time setting. For example, a heating process loop is operating at set point in steady state with an output cycle time of 30 seconds and output at 50% (15 seconds ON, 15 seconds OFF). If the 15 second OFF time has just begun when cold material is added to the process, causing the temperature to drop suddenly, a large enough rate setting will cause the 15 second off-time to immediately end and the output to again turn ON.

### Soak Interval

A Soak Interval is an interval in a Ramp/Soak program where the process temperature is held constant over a specified period of time. See **Guaranteed Soak** for more information on soak intervals.



**Tuning Procedure**  
**PID**  
**PAGE 19-20/MENU 3-10**

The following procedure gives you basic instructions for PID turning. In applications where the 2030 is being used as a Proportional (P), Proportional with Integral (PI) or Proportional with Integral and Derivative (PID) controller, the following tuning procedure will help you determine the parameter setting(s) that will provide optimum process stability. These parameter values, once determined, are entered on PAGE 19-20:

Proportional Band\*      PAGE 19-20/MENU 3-6  
Automatic Reset (Integral) PAGE 19-20/MENU 7-8  
Rate (Derivative)      PAGE 19-20/MENU 9-10

PAGE 19-20/MENU 3-4 allow you to define two possible Proportional Band settings for heat, and MENU 5-6 allow you to define two Proportional Band settings for cool. In applications where Ramp/Soak program are not selected on PAGE 18/MENU 2 (single set point operation), Heat Proportional Band #1 and Cool Proportional Band #1 are always selected when the control output is calculated.

If a Ramp/Soak program is selected on PAGE 18/MENU 2, Proportional Band #1 or #2 may be selected for the entire program. If two different proportional bands are required within a single program ramp/soak sequence, then the first program (using PB #1) should be linked to a second program (using PB #2).

Definitions of the three PID control parameters are presented earlier in this section.

**Tuning Procedure**

There are three applications of the 2030 controller in which the Tuning Procedure is applied:

PID control is selected for Heat only,

PID control is selected for Cool only, and

PID control is selected for both Heat and Cool.

The Tuning Procedure consists of three steps:

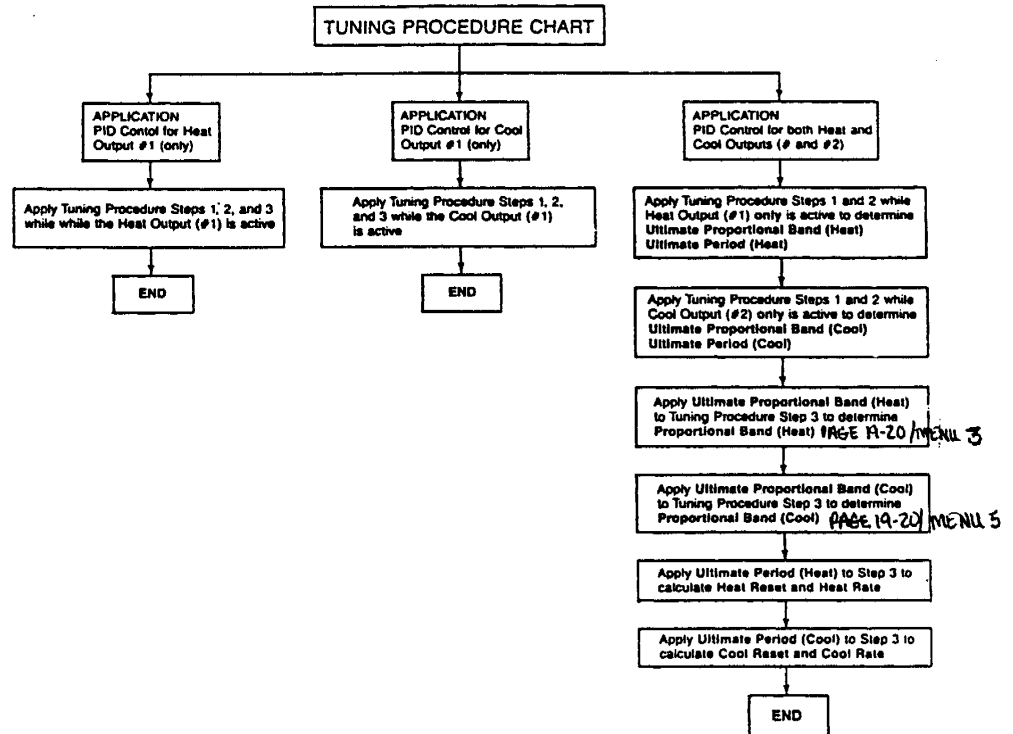
Step 1: Determining Ultimate Proportional Band

Step 2: Determining Ultimate Period

Step 3: Calculating Parameters - Proportional Band (P), Automatic Reset (I) and Rate (D)

The following Tuning Procedure Chart will tell you how to apply these Steps, based on your application of the 2030 controller.

The following Tuning Procedure Chart will tell you how to apply these Steps, based on your application of the 2030 controller.



**Step 1: Ultimate Proportional Band**

The controller should be tuned while operating in the process as a Proportional Only controller (P). It is important that Automatic Reset (PAGE 19-20/MENU 7-8) and Rate (PAGE 19-20/MENU 9-10) be set at 0.00 and 0, respectively.

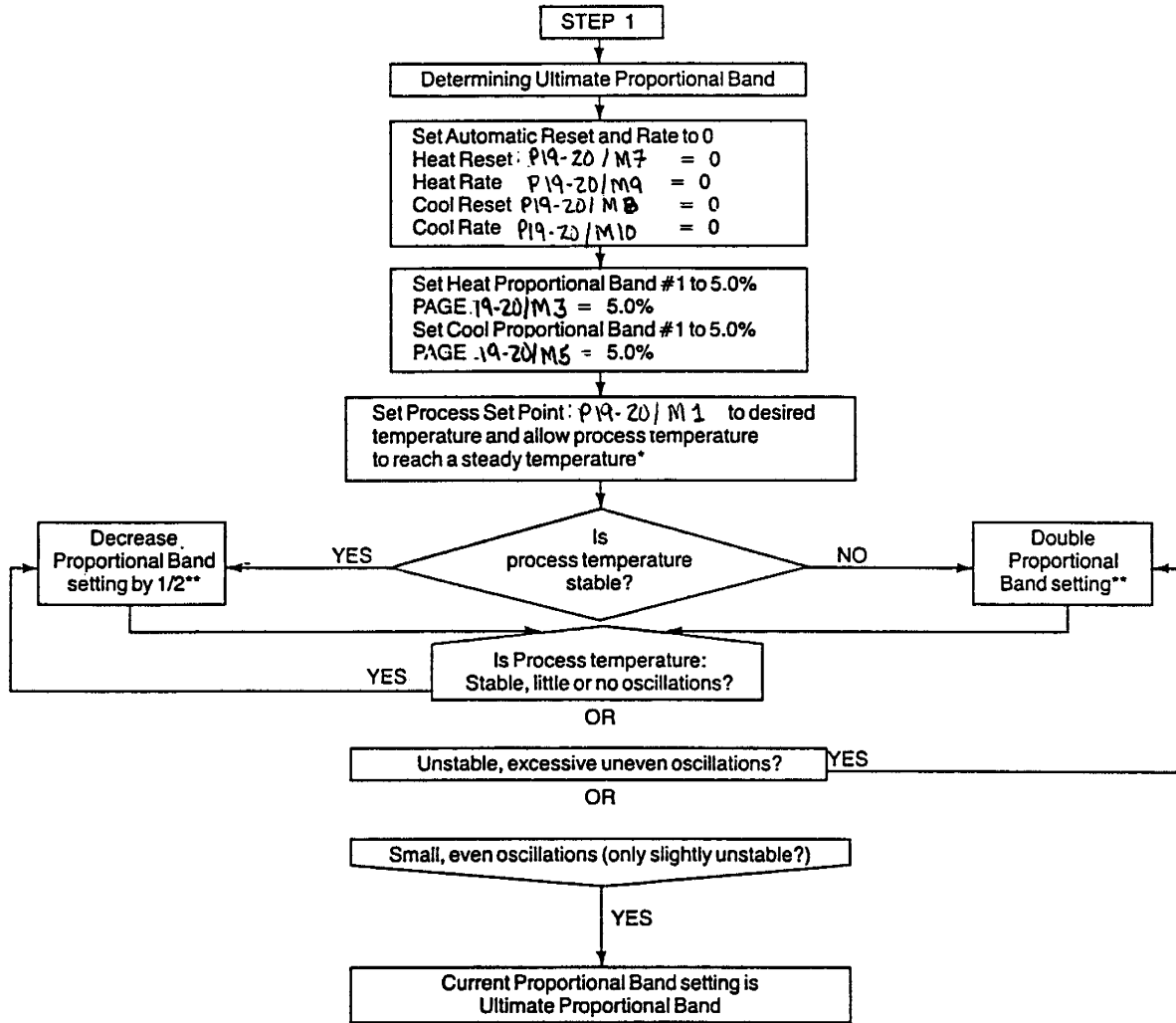
Following Step 1, below, the Proportional Band setting is gradually increased/decreased until the process temperature begins a **steady, small oscillation** that is slightly unstable. The Proportional Band setting where this steady, small oscillation occurs is referred to as the **Ultimate Proportional Band** (expressed in % of span). This slightly unstable condition is the objective of Step 1.

**Stable** = steady process temperature does not increase or decrease greatly with time, no oscillation (except oscillation due to output cycle time).

**Unstable** = process temperature has extreme, unstable excursions.

**Slightly Unstable** = process temperature has steady, small, even oscillations.

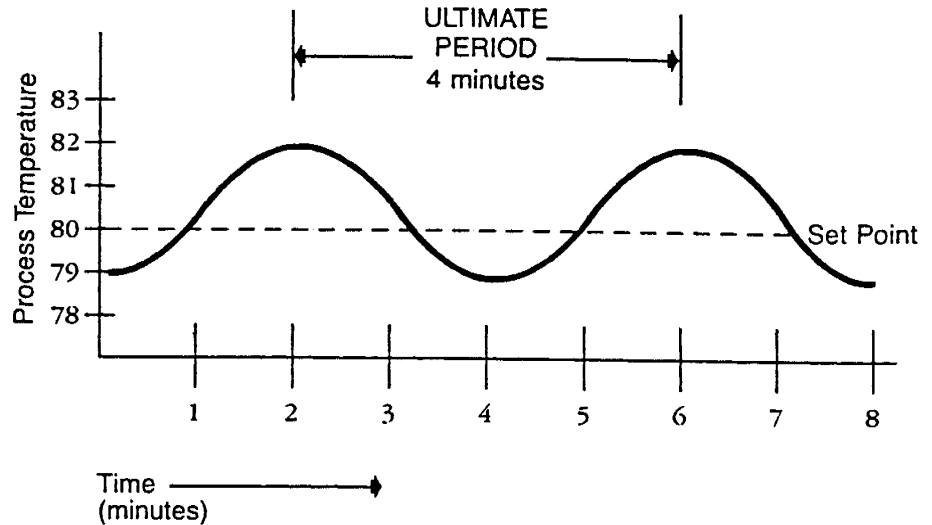
The **Stable** process temperature is most desirable for normal operation, while **Unstable** is the least desirable. The **Slightly Unstable** condition is the condition generated in this flowchart procedure that allows determination of Ultimate Proportional Band and Ultimate Period.



- \* The process temperature may become steady as much as 50°F above or below set point, which is acceptable for this initial tuning step. This offset will be corrected in later tuning steps.
- \*\* Note that by simply doubling and halving settings, an optimum *slightly unstable* condition may never be reached. The operator must use discretion in increasing and decreasing settings to reach the optimum slightly unstable condition.

## STEP 2: ULTIMATE PERIOD

Once the Ultimate Proportional Band setting is determined, and the process temperature is reacting in a steady, small oscillation, the Ultimate Period is determined. The Ultimate Period is the time (in minutes) from peak-to-peak maximum temperature in the process temperature curve. Graph your process temperature curve like the example shown below to determine your Ultimate Period.



## STEP 3: CALCULATING PID PARAMETERS

The process values **Ultimate Proportional Band (PB)** and **Ultimate Period (Period)** are applied to equations to determine **Proportional Band**, **Automatic Reset** and **Rate**. Select the appropriate control mode for your application (P, PI, PID) in the table below, and follow the equations below the mode to calculate your PID Parameters. Remember to use the Heat Ultimate Proportional Band and Heat Ultimate Period to calculate the Heat PID Parameters, and the Cool Ultimate Proportional Band and Cool Ultimate Period to calculate the Cool PID Parameters.

Parameter	P	PI	PID
Proportional Band	$2 \times \text{PB}$	$2.22 \times \text{PB}$	$1.67 \times \text{PB}$
Automatic Reset		$1.2 / \text{Period (min)}$	$2.0 / \text{Period (min)}$
Rate			$\text{Period (sec)} / 8$

PB = Ultimate Proportional Band  
 Period = Ultimate Period



## APPENDIX II PAGE/MENU TABLES, CONDENSED

This section contains the 19 PAGES of programming information, PAGES 0-18, without any of the detailed information or explanations given in the individual Sections of the User's Manual. This Appendix is intended for your use after you have read the manual completely and fully understand the PAGE/MENU selections.

PAGE 0: DISPLAY <i>DISP</i>			
CUE	MENU #	DISPLAY	SECURITY LEVEL
<i>DISP</i>	1	Channel #1 Process set point in units of process variable	A
<i>DISP</i>	2	Channel #2 Process set point in units of process variable	
<i>DEVI</i>	3	Channel #1 Deviation from set point in units of process variable	
<i>DEVI</i>	4	Channel #2 Deviation from set point in units of process variable	
<i>PROG</i>	5	Program Number	
<i>INT</i>	6	Interval Number	
<i>LEFT</i>	7	Time Left in Interval	
<i>HEAT</i>	8	Channel #1 Heat Output command in % full ON	
<i>COOL</i>	9	Channel #1 Cool Output command in % full ON	
<i>HEAT</i>	10	Channel #2 Heat Output command in % full ON	
<i>COOL</i>	11	Channel #2 Cool Output command in % full ON	

PAGE 1-16: RAMP/SOAK PROGRAMS 1.1 - 4.4					
PAGE 1 = Program 1.1		PAGE 5 = Program 1.2		PAGE 9 = Program 1.3	
PAGE 2 = Program 2.1		PAGE 6 = Program 2.2		PAGE 10 = Program 2.3	
PAGE 3 = Program 3.1		PAGE 7 = Program 3.2		PAGE 11 = Program 3.3	
PAGE 4 = Program 4.1		PAGE 8 = Program 4.2		PAGE 12 = Program 4.3	
PAGE 13 = Program 1.4		PAGE 14 = Program 2.4		PAGE 15 = Program 3.4	
PAGE 16 = Program 4.4					
CUE	MENU	SELECTION	AVAILABLE SETTINGS	FACTORY SETTING	SEC.
<i>SBY1</i>	1	Channel #1 Standby Set Point	Set Point Span	77°F	B
<i>SBY2</i>	2	Channel #2 Standby Set Point	%	50.0% RH	
<i>INT1</i>	3	Interval 1 Time Span	0 = End Program 1 to 9999 seconds 0.1 to 999.9 minutes 0.01 to 99.99 hours (dependent on time units chosen in MENU 27)	0.0 minutes	
<i>SP1</i>	4	Channel #1 Set Point 1	Set Point Span	77°F	
<i>SP2</i>	5	Channel #2 Set Point 1	Set Point Span	50.0% RH	
<i>INT2</i>	6	Interval 2 Time Span	0 = End Program 1 to 9999 seconds 0.1 to 999.9 minutes 0.01 to 99.99 hours (dependent on time units chosen in MENU 27)	0.0 minutes	
<i>SP2</i>	7	Channel #1 Set Point 2	Set Point Span	77°F	
<i>SP2</i>	8	Channel #2 Set Point 2	Set Point Span	50.0% RH	

**PAGE 1-16: RAMP/SOAK PROGRAMS 1.1 - 4.4**

PAGE 1 = Program 1.1	PAGE 5 = Program 1.2	PAGE 9 = Program 1.3	PAGE 13 = Program 1.4
PAGE 2 = Program 2.1	PAGE 6 = Program 2.2	PAGE 10 = Program 2.3	PAGE 14 = Program 2.4
PAGE 3 = Program 3.1	PAGE 7 = Program 3.2	PAGE 11 = Program 3.3	PAGE 15 = Program 3.4
PAGE 4 = Program 4.1	PAGE 8 = Program 4.2	PAGE 12 = Program 4.3	PAGE 16 = Program 4.4

CUE	MENU	SELECTION	AVAILABLE SETTINGS	FACTORY SETTING	SEC.
int3	9	Interval 3 Time Span	0 = End Program 1 to 9999 seconds 0.1 to 999.9 minutes 0.01 to 99.99 hours (dependent on time units chosen in MENU 27)	0.0 minutes	
ISP3	10	Channel #1 Set Point 3	Set Point Span	77°F	
ZSP3	11	Channel #2 Set Point 3		50.0% RH	
int4	12	Interval 4 Time Span	0 = End Program 1 to 9999 seconds 0.1 to 999.9 minutes 0.01 to 99.99 hours (dependent on time units chosen in MENU 27)	0.0 minutes	
ISP4	13	Channel #1 Set Point 4	Set Point Span	0°F	
ZSP4	14	Channel #2 Set Point 4		%	
int5	15	Interval 5 Time Span	0 = End Program 1 to 9999 seconds 0.1 to 999.9 minutes 0.01 to 99.99 hours (dependent on time units chosen in MENU 27)	0.0 minutes	B
ISP5	16	Channel #1 Set Point 5	Set Point Span	77.0°F	
ZSP5	17	Channel #2 Set Point 5		50% RH	
int6	18	Interval 6 Time Span	0 = End Program 1 to 9999 seconds 0.1 to 999.9 minutes 0.01 to 99.99 hours (dependent on time units chosen in MENU 27)	0.0 minutes	
ISP6	19	Channel #1 Set Point 6	Set Point Span	77.0°F	
ZSP6	20	Channel #2 Set Point 6		50% RH	
int7	21	Interval 7 Time Span	0 = End Program 1 to 9999 seconds 0.1 to 999.9 minutes 0.01 to 99.99 hours (dependent on time units chosen in MENU 27)	0.0 minutes	
ISP7	22	Channel #1 Set Point 7	Set Point Span	77.0°F	
ZSP7	23	Channel #2 Set Point 7		50% RH	
int8	24	Interval 8 Time Span	0 = End Program 1 to 9999 seconds 0.1 to 999.9 minutes 0.01 to 99.99 hours (dependent on time units chosen in MENU 27)	0.0 minutes	

**PAGE 1-16: RAMP/SOAK PROGRAMS 1.1 - 4.4**

PAGE 1 = Program 1.1  
 PAGE 2 = Program 2.1  
 PAGE 3 = Program 3.1  
 PAGE 4 = Program 4.1

PAGE 5 = Program 1.2  
 PAGE 6 = Program 2.2  
 PAGE 7 = Program 3.2  
 PAGE 8 = Program 4.2

PAGE 9 = Program 1.3  
 PAGE 10 = Program 2.3  
 PAGE 11 = Program 3.3  
 PAGE 12 = Program 4.3

PAGE 13 = Program 1.4  
 PAGE 14 = Program 2.4  
 PAGE 15 = Program 3.4  
 PAGE 16 = Program 4.4

CUE	MENU	SELECTION	AVAILABLE SETTINGS	FACTORY SETTING	SEC.
1SPB	25	Channel #1 Set Point 8	Set Point Span	77.0°F	B
2SPB	26	Channel #2 Set Point 8		50% RH	
Unit	27	Time Units	1 = 1 to 9999 seconds 2 = 0.1 to 999.9 minutes 3 = 0.01 to 99.99 hours	2 = 0.1 to 999.9 minutes	C
1PB	28	Channel #1 Proportional Band	1 = Proportional Band #1 2 = Proportional Band #2	1 = Heat Prop. Band #1	
2PB	29	Channel #2 Proportional Band	1 = Proportional Band #1 2 = Proportional Band #2	1 = Cool Prop. Band #1	
RECIP	30	Recovery Options after Power Outage	0 = Go to Standby 1 = Resume Program 2 = Hold at Current Oper. Status	2 = Hold at Current Status	
1Fro	31	LOOP 1 - Loop from the end of Interval A	A = 0 to 8	0 = Disable	C
1 to	32	to the beginning of Interval B	B = 0 to 8	0 = Disable	
1 no.	33	C number of times	C = 0 to 255 (0 = Continuous)	1 = Once	
2Fro	34	LOOP 2 - Loop from the end of Interval A	A = 0 to 8	0 = Disable	C
2 to	35	to the beginning of Interval B	B = 0 to 8	0 = Disable	
2 no.	36	C number of times	C = 0 to 255 (0 = Continuous)	1 = Once	
3Fro	37	LOOP 3 - Loop from the end of Interval A	A = 0 to 8	0 = Disable	C
3 to	38	to the beginning of Interval B	B = 0 to 8	0 = Disable	
3 no.	39	C number of times	C = 0 to 255 (0 = Continuous)	1 = Once	
Link	40	LINK the end of this Program to the beginning of Program #	0 = No Linking 1 = Program #1.1 2 = Program #2.1 3 = Program #3.1 4 = Program #4.1 5 = Program #1.2 6 = Program #2.2 7 = Program #3.2 8 = Program #4.2 9 = Program #1.3 10 = Program #2.3 11 = Program #3.3 12 = Program #4.3 13 = Program #1.4 14 = Program #2.4 15 = Program #3.4 16 = Program #4.4	0 = No Linking	



**PAGE 1-16: RAMP/SOAK PROGRAMS 1.1 - 4.4**

PAGE 1 = Program 1.1	PAGE 5 = Program 1.2	PAGE 9 = Program 1.3	PAGE 13 = Program 1.4
PAGE 2 = Program 2.1	PAGE 6 = Program 2.2	PAGE 10 = Program 2.3	PAGE 14 = Program 2.4
PAGE 3 = Program 3.1	PAGE 7 = Program 3.2	PAGE 11 = Program 3.3	PAGE 15 = Program 3.4
PAGE 4 = Program 4.1	PAGE 8 = Program 4.2	PAGE 12 = Program 4.3	PAGE 16 = Program 4.4

CUE	MENU	SELECTION	AVAILABLE SETTINGS	FACTORY SETTING	SEC.
5bEt	41	Standby	0 to 255 (Any Sum of Event ON Codes)	0	D
1 Et	42	Interval 1		0	
2 Et	43	Interval 2		0	
3 Et	44	Interval 3		0	
4 Et	45	Interval 4		0	
5 Et	46	Interval 5		0	
6 Et	47	Interval 6		0	
7 Et	48	Interval 7		0	
8 Et	49	Interval 8	0		
5 OP	50	Standby	0 to 63	0	D
1 OP	51	Interval 1	0 to 63	0	
2 OP	52	Interval 2	0 to 63	0	
3 OP	53	Interval 3	0 to 63	0	
4 OP	54	Interval 4	0 to 63	0	
5 OP	55	Interval 5	0 to 63	0	
6 OP	56	Interval 6	0 to 63	0	
7 OP	57	Interval 7	0 to 63	0	
8 OP	58	Interval 8	0 to 63	0	D
C1S	59	Guar. Soak Differential for Channel #1	0.1 to 25.5% span	1.0% span	
C2S	60	Guar. Soak Differential for Channel #2		1.0% span	

**PAGE 17: RAMP/SOAK NESTED PROGRAM LOOPS**

CUE	MENU	SELECTION	AVAILABLE SETTINGS	FACTORY SETTING	SEC.
<b>NESTED LOOP #1</b>					
1Pr	1	Loop from Program A=	0 = No Looping 1 = Program #1.1 2 = Program #2.1 3 = Program #3.1 4 = Program #4.1 5 = Program #1.2 6 = Program #2.2 7 = Program #3.2 8 = Program #4.2 9 = Program #1.3 10 = Program #2.3 11 = Program #3.3 12 = Program #4.3 13 = Program #1.4 14 = Program #2.4 15 = Program #3.4 16 = Program #4.4	0 = Disabled	B
1Bn	2	Interval B=	B = 1 to 8	1	
1CPr	3	to Program C=	1 - 16 = Program #1.1 - #4.4 See MENU 1 selections	1	
1Dn	4	Interval D=	D = 1 to 8	1	
1na.	5	E number of times	E = 0 to 255 (0 = Continuous)	0	

<b>PAGE 17: RAMP/SOAK NESTED PROGRAM LOOPS</b>					
<b>CUE</b>	<b>MENU</b>	<b>SELECTION</b>	<b>AVAILABLE SETTINGS</b>	<b>FACTORY SETTING</b>	<b>SEC.</b>
<b>NESTED LOOP #2</b>					
2FFr	6	Loop from Program A=	0 = No Looping 1 - 16 = Program #1.1 - #4.4 See MENU 1 selections	0 = Disabled	B
2Fin	7	Interval B=	B = 1 to 8	1	
2tPr	8	to Program C=	1 - 16 = Program #1.1 - #4.4 See MENU 1 selections	1	
2Ein	9	Interval D=	D = 1 to 8	1	
2no.	10	E number of times	E = 0 to 255 (0 = Continuous)	0	
<b>NESTED LOOP #3</b>					
3FFr	11	Loop from Program A=	0 = No Looping 1 - 16 = Program #1.1 - #4.4 See MENU 1 selections	0 = Disabled	B
3Fin	12	Interval B=	B = 1 to 8	1	
3tPr	13	to Program C=	1 - 16 = Program #1.1 - #4.4 See MENU 1 selections	1	
3Ein	14	Interval D=	D = 1 to 8	1	
3no.	15	E number of times	E = 0 to 255	0	
<b>NESTED LOOP #4</b>					
4FFr	16	Loop from Program A=	0 = No Looping 1 - 16 = Program #1.1 - #4.4	0 = Disabled	B
4Fin	17	Interval B=	B = 1 to 8	1	
4tPr	18	to Program C=	1 - 16 = Program #1.1 - #4.4 See MENU 1 selections	1	
4Ein	19	Interval D=	D = 1 to 8	1	
4no.	20	E number of times	E = 0 to 255 (0 = Continuous)	0	

<b>PAGE 18: GENERAL OPERATION</b>					
<b>CUE</b>	<b>MENU</b>	<b>SELECTION</b>	<b>AVAILABLE SETTINGS</b>	<b>FACTORY SETTING</b>	<b>SEC.</b>
Lock	1	Security Lock	Security Codes (0 to 9999)	458 = Level D	A
prog	2	Program Selection	0 = None (Single set point control, Ramp/Soak Program not selected) 1 = Program #1.1 2 = Program #2.1 3 = Program #3.1 4 = Program #4.1 5 = Program #1.2 6 = Program #2.2 7 = Program #3.2 8 = Program #4.2 9 = Program #1.3 10 = Program #2.3 11 = Program #3.3 12 = Program #4.3 13 = Program #1.4 14 = Program #2.4 15 = Program #3.4 16 = Program #4.4		B

**PAGE 18: GENERAL OPERATION**

CUE	MENU	SELECTION	AVAILABLE SETTINGS	FACTORY SETTING	SEC.
Cont	3	Controller Type	1 = Single Channel Controller 2 = Dual Channel Controller Channel #1 = temperature Channel #2 = humidity 3 = Dual Channel Controller Channel #1 = temperature Channel #2 = temperature	2 = Dual Channel Temp/Humd	D
SEN1	4	Sensor Input Selection Channel #1	1 = T Thermocouple 2 = 100 ohm Platinum RTD, High Range -110.0 to 425.0°F 3 = 100 ohm Platinum Rtd, Low Range 32.0 to 212.0°F 4 = 4-20 mA (1-5 Vdc)	2 = RTD, High	
SEN2	5	Sensor Input Selection Channel #2	1 = T Thermocouple 2 = 100 ohm Platinum RTD, High Range -110.0 to 425.0°F 3 = 100 ohm Platinum Rtd, Low Range 32.0 to 212.0°F 4 = 4-20 mA (1-5 Vdc)	3 = RTD, Low	
Un 1	6	Channels #1 and #2 Temperature Units or Channel #1 Units for 4-20 mA/ 1-5Vdc	1 = °F or 0.0 to 100.0% 2 = °C or 0 to 100% 3 = 0.00 to 99.99% (Basic)	1 = °F	
Un 2	7	Channel #2 Relative Humidity Units or Units for 4-20 mA/ 1-5Vdc	1 = 0.0 to 100.0% 2 = 0 to 100% 3 = 0.00 to 99.99% (Basic)	1 = Relative Humidity	
BP	8	Barometric Pressure	0 to 99.99 inches of Mercury	29.92 inches	
AOut	9	Process Analog Output Assignment	0 = Analog Output Disabled 1 = Channel #1 Heat Control Output 2 = Channel #1 Cool Control Output 3 = Channel #2 Heat Control Output 4 = Channel #2 Cool Control Output 5 = Channel #1 Process Variable 6 = Channel #2 Process Variable 7 = Channel #1 Set Point 8 = Channel #2 Set Point	6 = Channel #2 Process Variable	
Bar	10	Analog Bar Graph Display Assignment	0 = Disable 1 = Time Left in Interval 2 = Channel #1 Heat Output Command 3 = Channel #1 Cool Output Command 4 = Channel #2 Heat Output Command 5 = Channel #2 Cool Output Command 6 = Channel #1 Deviation from Set Point 7 = Channel #2 Deviation from Set Point	1 = Time Left in Interval	
LABL	11	Alphanumeric Cues	0 = No Cues 1 = PAGE Cues 2 = MENU Cues 4 = Value Cues SUM of any of the above setting	7 = PAGE Cues (1) + MENU Cues (2) + Value Cues(4)	

**PAGE 19: CHANNEL #1 BIMODAL CONTROL AND ALARM PARAMETERS**  
**PAGE 20: CHANNEL #2 BIMODAL CONTROL AND ALARM PARAMETERS**

CUE	MENU	SELECTION	AVAILABLE SETTINGS	FACTORY SETTING	SEC.
SP	1	Set Point (for single set point operation - no Ramp/Soak Program selected)	Instrument Sensor Range	PAGE 19: 77.0°F PAGE 20: 50% RH	B
DFSE	2	Manual Reset	-100.0 to 100.0	0.0	D
HPb1	3	Heat Prop. Band #1	0.1 to 999.9% span	5.0	D
HPb2	4	Heat Prop. Band #2			
CPb1	5	Cool Prop. Band #1			
CPb2	6	Cool Prop. Band #2			
HRSE	7	Heat Automatic Reset (I)			
CRSE	8	Cool Automatic Reset (I)			
HRE	9	Heat Rate (D)	0 to 1000 seconds	0	
CRE	10	Cool Rate (D)			
HDFS	11	Heat Offset (PID)	-25.00 to 25.00% of proportional band	0.00	
COFS	12	Cool Offset (PID)			
LAPH	13	Heat Overlap	0.0 to 1000.1% Prop. Band	0.0	
LAPC	14	Cool Overlap			
HELE	15	Heat Output Limit	0.0 to 100.0% ON	100.0%	
CLE	16	Cool Output Limit			
HCFE	17	Heat Cycle Time	0.1 to 65.0 seconds	4.0	
CCFE	18	Cool Cycle Time			
HLOF	19	Heat Offset (ON/OFF)	-25.00 to 25.00% of instrument sensor range	0.00	D
CLOF	20	Cool Offset			
HEDb	21	Heat Deadband	0.01 to 25.00% of instrument sensor range	0.01	
CEDb	22	Cool Deadband			
Ctrl	23	Control Modes	1 = Heat PID, Cool PID 2 = Heat PID, Cool ON/OFF 3 = Heat ON/OFF, Cool PID 4 = Heat ON/OFF, Cool ON/OFF	1 = Heat PID, Cool PID	D
RISP	24	Alarm #1 Set Point	Instrument Sensor Range	Sensor Range Maximum	
R2SP	25	Alarm #2 Set Point		Sensor Range Maximum	
R1TY	26	Alarm #1 Type	0 = Disable 1 = High Alarm, NDE* 2 = Low Alarm, NDE 3 = + Deviation, NDE 4 = - Deviation, NDE 5 = +/- Deviation, NDE 6 = High Alarm, NE** 7 = Low Alarm, NE 8 = + Deviation, NE 9 = - Deviation, NE 10 = +/- Deviation, NE	0 = Disable	D
R2TY	27	Alarm #2 Type	NDE* = Normally de-energized, (contact closed on alarm) NE** = Normally energized, (contact open on alarm)	0 = Disable	
R1Db	28	Alarm #1 Deadband	0.01 to 25.00% instrument sensor range	0.25	
R2Db	29	Alarm #2 Deadband			
R1On	30	Alarm #1 ON Delay	0.1 to 999.9 seconds	0.1	
R2On	31	Alarm #2 ON Delay			

**PAGE 19: CHANNEL #1 BIMODAL CONTROL AND ALARM PARAMETERS**

**PAGE 20: CHANNEL #2 BIMODAL CONTROL AND ALARM PARAMETERS**

CUE	MENU	SELECTION	AVAILABLE SETTINGS	FACTORY SETTING	SEC.
A1oF	32	Alarm #1 OFF Delay	0.1 to 999.9 seconds	0.1	D
A2oF	33	Alarm #2 OFF Delay			
A1rA	34	Alarm #1 Output Relay Assignment	1 = Event Output 1 2 = Event Output 2 4 = Event Output 3 8 = Event Output 4 16 = Event Output 5 32 = Event Output 6	128 = Event Output 8	D
A2rA		Alarm #2 Output Relay Assignment	64 = Event Output 7 128 = Event Output 8		

**PAGE 21: DIGITAL COMMUNICATIONS / AUTOMATIC DATA LOGGING**

CUE	MENU	SELECTION	AVAILABLE SETTINGS	FACTORY SETTING	SEC.
Frac	1	Operation Mode	0 = Disabled 1 = Terminal Interface 2 = Automatic Data Logging 3 = Computer Interface 4 = Line Mode	0 = Disabled	E
L0Li	2	Automatic Data Logging Interval	1 to 9999 minutes	1 minutes	
LFr0	3	First MENU # to Display (from PAGE 0)	1 to 11	1	
Lto	4	Last MENU # to Display (from PAGE 0)	1 to 11	11	

---

## Warranty and Return

The warranty below complies with the Federal Law applicable to products manufactured after December 31, 1976. This warranty gives you specific legal rights. You may also have other rights which vary from state to state.

### ■ Chromalox Warranty

Chromalox Instruments and Controls' products are warranted against defects in workmanship and materials. No other express warranty, written or oral, applies with exception of a written statement from an officer of Chromalox Instruments and Controls, Edwin L. Wiegand Division, Emerson Electric Co.

### ■ Warranty Period

This warranty extends for twelve months from date of shipment from factory or authorized distributor.

### ■ Limitations

Products must be installed and maintained in accordance with Chromalox instructions. Users are responsible for the suitability of the products to their application. There is no warranty against damage resulting from corrosion, misapplication, improper specification or other operating conditions beyond our control. Claims against carriers for damage in transit must be filed by the buyer.

### ■ Returns

Items returned to Chromalox Instruments and Controls must be accompanied by a Return Authorization Number. This number may be obtained from Chromalox Instruments and Controls, Customer Service Department, Telephone Number (615) 793-3900. Defective items will be repaired or replaced at our option, at no charge.

Return the defective part or product, freight prepaid to:

Chromalox Instruments and Controls  
1382 Heil Quaker Blvd.  
LaVergne, TN 37086-3536  
FAX: (615) 793-3563

**SUCH REPAIR OR REPLACEMENT IS THE EXCLUSIVE REMEDY AVAILABLE FROM CHROMALOX INSTRUMENTS AND CONTROLS, EDWIN L. WIEGAND DIVISION, EMERSON ELECTRIC CO. CHROMALOX INSTRUMENTS AND CONTROLS IS NOT LIABLE FOR LABOR COSTS INCURRED IN REMOVAL, REINSTALLATION OR UNAUTHORIZED REPAIR OF THE PRODUCT OR FOR CONSEQUENTIAL DAMAGE.** Some state do not allow the exclusion or limitations of incidental or consequential damages, so the preceding limitation or exclusion may not apply to you.

